

GJELDER FRA 01. APRIL 2024

GEBERIT RØR- SYSTEMER 2024

**KNOW
HOW**
INSTALLED

Geberit Mapress El-Forsinket Stål	7
Geberit Mapress Syrefast Stål	33
Geberit Mapress Kobber	73
Geberit Mapress CuNiFe	105
Geberit Mepla	121
Geberit FlowFit	139
Rørarmaturer	161
Geberit hygienesystem	167
Geberit Silent-Pro	175
Geberit Silent-PP	189
Geberit Silent-db20	207
Geberit PE	221
Geberit Pluvia takdrenering	257
Brannvern, lydisolering og fuktighetsvern	269
Ventilatorventiler for avløp	273
Verktøy	277
Vedlegg	319

GEBERIT SILENT-PRO SUPERTUBE GIR DEG MER Plass

TILGJENGELIG
FRA APRIL
2024



ENKLERE RØRFØRING MED SILENT-PRO SUPERTUBE

Med de nye Geberit Silent-Pro SuperTube-rørdelene kan avløp fra leilighetsbygg lages uten forbudte tilknytnings soner. Bypass er ikke lenger nødvendig og horisontale rør med d110 inntil 6 meter eller med d90 inntil 4 meter i lengde kan legges uten fall. Dette frigjør plass.

SYSTEMSAMMENLIGNING I LEILIGHETSBYGNINGER MED FALLSTAMME HØYERE ENN 10 METER

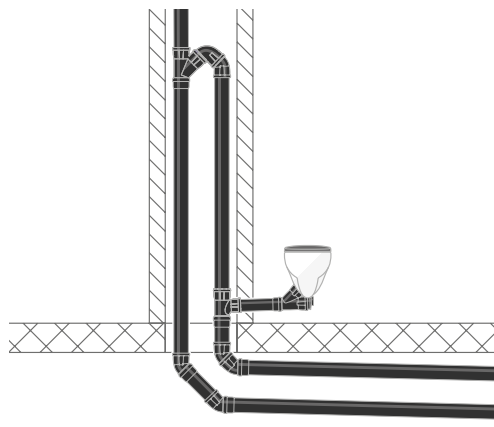

Konvensjonelt avløp i hus med ekstra bypass på grunn av forbudte tilkoblingssoner og med fall på det horisontale røret.

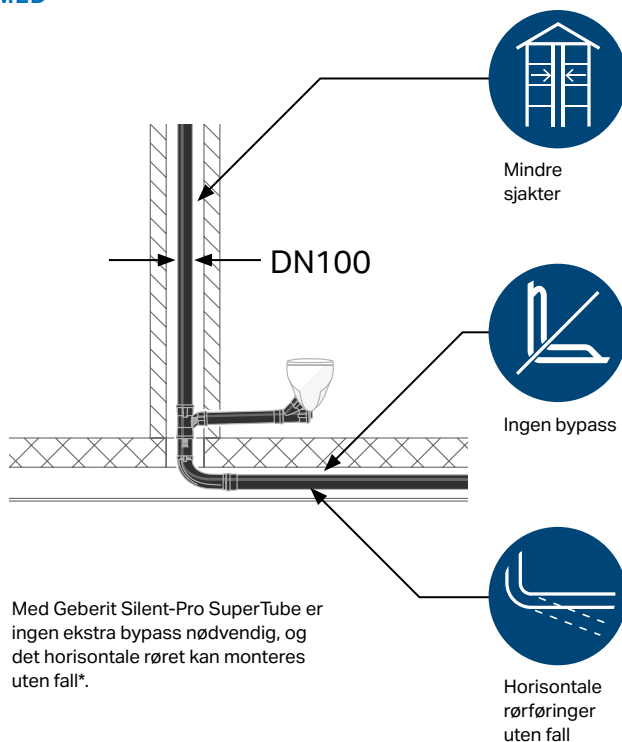

Med Geberit Silent-Pro SuperTube er ingen ekstra bypass nødvendig, og det horisontale røret kan monteres uten fall*.

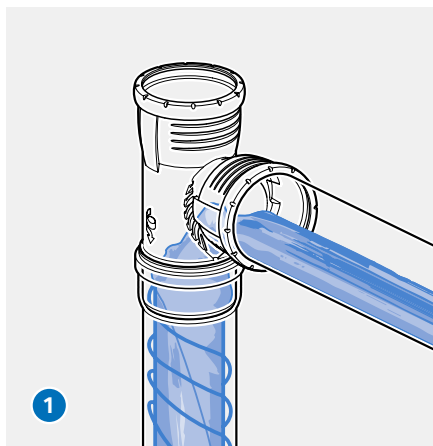

GEBERIT SILENT-PRO CARVE GRENRØR

Den optimaliserte produktgeometrien leder det innstrømmende avløpsvannet tangentielt inn i fallstammen. Den ringformede strømmen gir rom for en stabil, kontinuerlig luftsøyle. Geberit Silent-Pro Carve grenrør oppnår dermed en 15 % høyere avløpskapasitet sammenlignet med et konvensjonelt

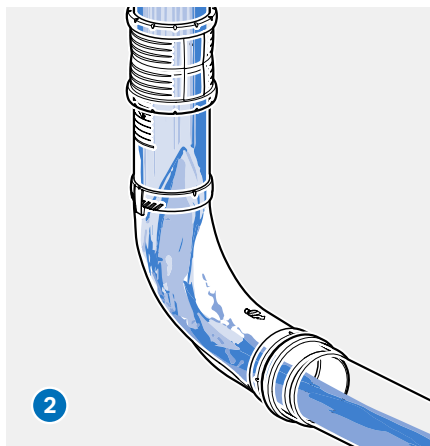

grenrør, swept-entry.

GEBERIT SILENT-PRO BOTTOMTURN BEND

Med Geberit Silent-Pro BottomTurn-rørdelen brytes vannets retning og den ringformede strømmen blir en lagdelt strømning uten å forstyrre luftsøylen. Denne retningsendringen gir et betydelig lavere impulstap enn ved konvensjonelle

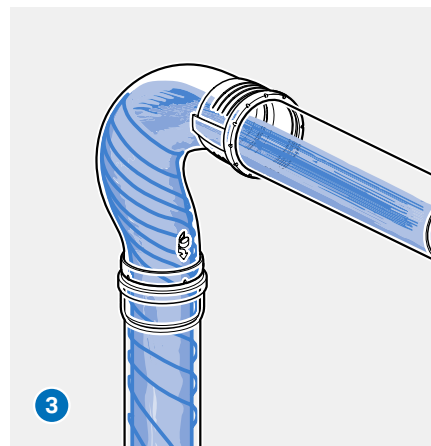

løsninger og det horisontale røret kan monteres uten fall*.

GEBERIT SILENT-PRO BACKFLIP BEND

Geberit Silent-Pro BackFlip-rørdelen konverterer den lagdelte strømmen tilbake til en ringformet strøm. Retningsendringen hindrer undertrykk i avløpssystemet.





Geberit Mapress EI-Forsinket Stål

Bruksoversikt – Geberit Mapress EI-Forsinket Stål.....	9
Geberit Mapress EI-Forsinket Stål	10
Systemrør 1.0034	10
Systemrør 1.0215	11
Muffer.....	11
Reduksjoner.....	12
Bend	13
T-stykker.....	15
Kryss	17
Overganger uløselige	18
Overganger og forbindelser, løsbare	23
Kompensatorer	26
Endedeksler.....	26
Tilkoblinger for varme	26
Tilbehør for Geberit Mapress EI-Forsinket Stål.....	28
Beskyttelse for rør og fittings	28
Klammer for rør	28
Systempakninger	29

Bruksoversikt – Geberit Mapress EI-Forsinket Stål

Geberit Norge, Versjon: oktober 2023

Bruksformål	Driftstemperatur	-30 – +120 °C ³⁾	Rør		
			EI-forsinket utvendig forsinket	EI-forsinket stål utvendig PP-belagt	EI-forsinket innvendig og utvendig forsinket
Flytende medier					
Til avkjøling og oppvarming av vann uten frostvæske	0–100 °C	16 bar / 1600 kPa	✓ ⁸⁾	✓ ⁸⁾	
Til avkjøling og oppvarming av vann med frostvæske	-30 – +120 °C ³⁾	16 bar / 1600 kPa	✓ ⁸⁾	✓ ⁸⁾	
For fjernvarmeoppvarmingsvann ≤ 120 °C	0–120 °C	16 bar / 1600 kPa	✓ ⁸⁾		
For fjernvarmeoppvarmingsvann ≤ 140 °C	0–140 °C	16 bar / 1600 kPa	✓ ⁸⁾		
For slukningsvann (vått)	0–100 °C	16 bar / 1600 kPa			✓
For sprinkler (våt)	0–100 °C	16 / 12 / 10 bar 1600 / 1200 / 1000 kPa ⁶⁾			✓
For varmebærer (sol)	-25 – +220 °C ⁴⁾	10 bar / 1000 kPa	✓ ⁸⁾		
For mineral- og smørelje	Ved forespørsel	Ved forespørsel	9)		
For drivstoff (f.eks. diesel)	Ved forespørsel	Ved forespørsel	9)		
Gassmedier					
For trykkluft (oljerenhetsklasse 2–3) ¹⁾	0–100 °C	25 / 16 / 12 bar 2500 / 1600 / 1200 kPa ⁷⁾			✓
For trykkluft (oljerenhetsklasse 3–X) ²⁾	0–100 °C	25 / 16 / 12 bar 2500 / 1600 / 1200 kPa ⁷⁾			✓

✓ Bruk er generelt godkjent når de definerte tilleggskravene iht. fotnotene er oppfylt

¹⁾ Oljerenhetsklasse iht. ISO 8573-1:2010E; for detaljer om fuktighet og partikler: Se teknisk informasjon "Geberit systemrør for trykkluftinstallasjoner"

²⁾ Oljerenhetsklasse iht. ISO 8573-1:2010E; for detaljer om fuktighet og partikler, se teknisk informasjon "Geberit rørdedningssystemer for trykkluftinstallasjoner"

³⁾ Bruk av hemmere, antikorrosjonsmidler, frostvæske bare etter godkjenning av Geberit

⁴⁾ Levetid med kollektorstopp: 200 t/a ved 180 °C, 60 t/a ved 200 °C, total 500 t/levetid ved 220 °C

⁵⁾ Bruk av hemmere, anti korrosjonsmidler, frostvæske bare etter godkjenning av Geberit

⁶⁾ 16 bar / 1600 kPa for d22-54mm, 12 bar / 1200 kPa for d66.7-76.1mm, 10 bar / 1000 kPa for d88.9-108mm

⁷⁾ 25 bar / 2500 kPa for d12-28mm, 16 bar / 1600 kPa for d35-54mm, 12 bar / 1200 kPa for d66.7-108mm

⁸⁾ Bare lukkede systemer

⁹⁾ Etter godkjenning fra Geberit



- For hver bruk må driftsbetingelsene i de retningsgivende tillatelsene, normene og tekniske regelverkene overholdes. Disse kan avvike fra angivelsene ovenfor.



	Fittings		Tetningsringer		Planpakninger for skrueforbindelser			Flenspakninger
	El-forsinket stål rød indikator	Messing hvit indikator	CIIR svart	FKM blå	EPDM svart	FPM grønn	Fiberkomposittmateriale	Fiberkomposittmateriale
	✓ ⁸⁾	✓ ⁸⁾	✓ ³⁾		✓ ³⁾		✓	✓
	✓ ⁸⁾	✓ ⁸⁾	✓ ³⁾				✓	✓
	✓ ⁸⁾	✓ ⁸⁾	✓ ³⁾			✓ ³⁾	✓	✓
	✓ ⁸⁾	✓ ⁸⁾		✓ ³⁾			✓	✓
	✓		✓		✓		✓	✓
	✓		✓		✓		✓	✓
	✓	✓		✓		✓	✓	✓
	9)			9)		9)	9)	9)
	9)			9)		9)	9)	9)
	✓		✓		✓		✓	✓
	✓			✓		✓	✓	✓

Geberit Mapress El-Forsinket Stål

Systemrør 1.0034

Geberit Mapress systemrør, utvendig el-forsinket stål

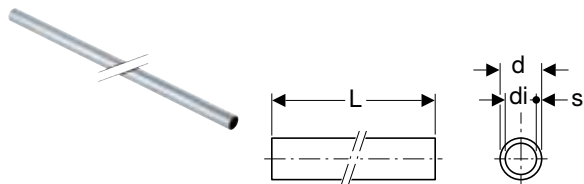

click & scan

Art. nr.	NRF nr.	DN	d, ø [mm]	di, ø [mm]	s [mm]
L / Lengde: 6 m					
29101	1080006	10	12	9,6	1,2
29102	1080001	12	15	12,6	1,2
29103	1080002	15	18	15,6	1,2
29104	1080003	20	22	19	1,5
29105	1080004	25	28	25	1,5
29106	1080005	32	35	32	1,5
29107	1080026	40	42	39	1,5
29108	1080029	50	54	51	1,5
29159	1080032	65	76,1	72,1	2
29160	1080033	80	88,9	84,9	2
29161	1080034	100	108	104	2

Tilbehør

- Geberit Mapress rørkutter R → s. 291
- Geberit Mapress avgrader → s. 292
- Geberit Mapress merkemal med merkepenn → s. 292

Geberit Mapress el-forsinket stål, plastmantlet

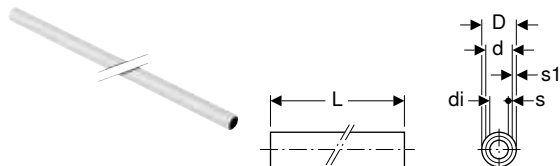

click & scan

Art. nr.	NRF nr.	DN	d, ø [mm]	di, ø [mm]	D [cm]	s1 [mm]	s [mm]	L [m]
19201	1080056	10	12	9,6	1,4	0,9	1,2	6
19202	1080059	12	15	12,6	1,7	0,9	1,2	6
19203	1080063	15	18	15,6	2	0,9	1,2	6
19204	1080066	20	22	19	2,4	0,9	1,5	6
19205	1080069	25	28	25	3	0,9	1,5	6
19206	1080073	32	35	32	3,7	0,9	1,5	6
19207	1080076	40	42	39	4,4	0,9	1,5	6
19208	1080079	50	54	51	5,6	0,9	1,5	6

Tilbehør

- Geberit Mapress rørkutter R → s. 291
- Geberit Mapress avmantlingsverktøy → s. 292
- Geberit Mapress avmantlingsverktøy → s. 292
- Geberit Mapress avgrader → s. 292
- Geberit Mapress merkemal med merkepenn → s. 292



Systemrør 1.0215

Geberit Mapress systemrør, innvendig og utvendig el-forsinket stål

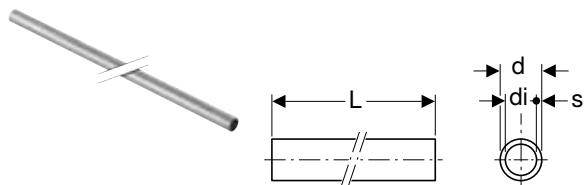

click & scan

Art. nr.	NRF nr.	DN	d, ø [mm]	di, ø [mm]	s [mm]	L [m]
19402		12	15	12	1,5	6
19403		15	18	15	1,5	6
19404	1080036	20	22	19	1,5	6
19405	1080037	25	28	25	1,5	6
19406	1080038	32	35	32	1,5	6
19407	1080039	40	42	39	1,5	6
19408	1080041	50	54	51	1,5	6
19409	1080042	65	76,1	72,1	2	6
19410	1080043	80	88,9	84,9	2	6
19411	1080044	100	108	104	2	6

Tilbehør

- Geberit Mapress rørkutter R → s. 291
- Geberit Mapress avgrader → s. 292
- Geberit Mapress merkemal med merkepenn → s. 292

Muffer

Geberit Mapress El-Forsinket Stål muffe



click & scan

Art. nr.	NRF nr.	DN	d, ø [mm]	L [cm]	Z [cm]
22001	1082506	10	12	4,2	0,8
22002	1082509	12	15	4,8	0,8
22003	1082513	15	18	4,8	0,8
22004	1082516	20	22	5	0,8
22005	1082519	25	28	5,4	0,8
22006	1082523	32	35	6,2	1
22007	1082526	40	42	7,1	1,1
22008	1082529	50	54	8,3	1,3
22009	1082532	65	76,1	12,7	2,1
22010	1082533	80	88,9	14,5	2,5
22011	1082534	100	108	17,6	2,6

Geberit Mapress El-Forsinket Stål muffe redusert



click & scan

Art. nr.	NRF nr.	DN	d, ø [mm]	d1, ø [mm]	L [cm]	Z [cm]
22023	1083827	40 / 32	42	35	7,9	1,9
22024	1083828	50 / 32	54	35	9,3	2,8
22025	1083829	50 / 40	54	42	9,2	2,3

Geberit Mapress El-Forsinket Stål glidemuffe

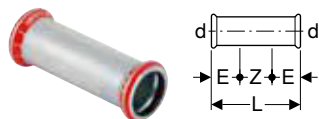

click & scan

Art. nr.	NRF nr.	DN	d, ø [mm]	E [cm]	L [cm]	Z [cm]
22101	1082546	10	12	2,5	6,7	1,7
22102	1082549	12	15	2,5	8	3
22103	1082553	15	18	2,5	8	3
22104	1082556	20	22	2,5	8,4	3,4
22105	1082559	25	28	3	9,1	3,1
22106	1082563	32	35	3	10,2	4,2
22107	1082566	40	42	4	12	4
22108	1082569	50	54	4	14	6
22109	1082572	65	76,1	6	23	11
22110	1082573	80	88,9	7	26	12
22111	1082574	100	108	8	31	15

Reduksjoner

Geberit Mapress El-Forsinket Stål reduksjon med spissende

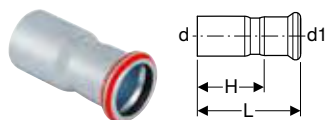

click & scan

Art. nr.	NRF nr.	DN	d, ø [mm]	d1, ø [mm]	L [cm]	H [cm]
22301	1082756	12 / 10	15	12	5,1	3,4
22302	1082759	15 / 10	18	12	5,3	3,6
22303	1082766	15 / 12	18	15	5,5	3,5
22304	1082763	20 / 10	22	12	6	4,3
22305	1082769	20 / 12	22	15	5,9	3,9
22306	1082776	20 / 15	22	18	5,7	3,7
22349	1082772	25 / 10	28	12	6,7	5
22307	1082773	25 / 12	28	15	6,6	4,6
22308	1082779	25 / 15	28	18	6,4	4,4
22309	1082783	25 / 20	28	22	6	3,9
22310	1082784	32 / 12	35	15	7,5	5,5
22311	1082785	32 / 15	35	18	7,4	5,5
22312	1082786	32 / 20	35	22	7,1	5
22313	1082789	32 / 25	35	28	6,8	4,5
22315	1082791	40 / 15	42	18	8	6
22316	1082792	40 / 20	42	22	8,2	6,1
22317	1082794	40 / 25	42	28	8,3	6
22318	1082793	40 / 32	42	35	7,7	5,1
22320	1082797	50 / 15	54	18	9,5	7,5
22321	1082798	50 / 20	54	22	9,5	7,4
22322	1082799	50 / 25	54	28	11	8,7
22323	1082801	50 / 32	54	35	10,6	8
22324	1082796	50 / 40	54	42	9,2	6,2
22330	1082803	65 / 40	76,1	42	12,7	9,7
22331	1082804	65 / 50	76,1	54	14,6	11,1
22338	1082805	80 / 50	88,9	54	16,2	12,8
22339	1082806	80 / 65	88,9	76,1	16,1	10,8
22345	1082807	100 / 50	108	54	17,2	13,7
22346	1082808	100 / 65	108	76,1	18,4	13,1
22348	1082809	100 / 80	108	88,9	20,3	14,3



Bend

Geberit Mapress El-Forsinket Stål bend

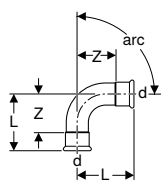

click & scan

Art. nr.	NRF nr.	DN	d, ø [mm]	L [cm]	Z [cm]
arc / Vinkel: 45°					
20601	1082358	10	12	3,2	1,5
20602	1082359	12	15	3,6	1,6
20603	1082363	15	18	3,7	1,7
20604	1082366	20	22	4,2	2,1
20605	1082369	25	28	4,8	2,5
23606	1082373	32	35	4,3	1,7
23607	1082376	40	42	5,1	2,1
23608	1082379	50	54	6,2	2,7
20609	1082382	65	76,1	10,3	5
20610	1082383	80	88,9	11,7	5,7
20611	1082384	100	108	14,3	6,8
arc / Vinkel: 90°					
20101	1082116	10	12	4,2	2,5
20102	1082119	12	15	4,9	2,9
20103	1082123	15	18	5,3	3,3
20104	1082126	20	22	6,1	4
20105	1082129	25	28	7,2	4,9
23106	1082133	32	35	6,8	4,2
23107	1082136	40	42	8	5
23108	1082139	50	54	10	6,5
20109	1082142	65	76,1	15,9	10,6
20110	1082143	80	88,9	18,5	12,5
20111	1082144	100	108	23	15,5

Geberit Mapress El-Forsinket Stål bend med spissende

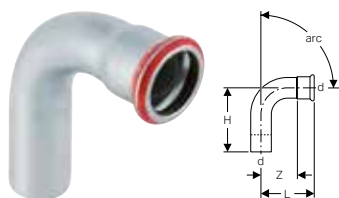

click & scan

Art. nr.	NRF nr.	DN	d, ø [mm]	L [cm]	H [cm]	Z [cm]
arc / Vinkel: 45°						
20701	1082408	10	12	3,2	4,1	1,5
20702	1082409	12	15	3,6	4,5	1,6
20703	1082413	15	18	3,7	4,2	1,7
20704	1082416	20	22	4,2	5,2	2,1
20705	1082419	25	28	4,8	5,6	2,5
23706	1082423	32	35	4,3	5,3	1,7
23707	1082426	40	42	5,1	6,1	2,1
23708	1082429	50	54	6,2	7,3	2,7
20709	1082432	65	76,1	10,3	11,1	5
20710	1082433	80	88,9	11,7	12,8	5,7
20711	1082434	100	108	14,3	15,8	6,8
arc / Vinkel: 90°						
20301	1082186	10	12	4,2	5,2	2,5
20302	1082189	12	15	4,9	5,9	2,9
20303	1082193	15	18	5,3	6,1	3,3
20304	1082196	20	22	6,1	7	4
20305	1082199	25	28	7,2	7,9	4,9
23306	1082203	32	35	6,8	7,4	4,2
23307	1082206	40	42	8	8,8	5
23308	1082209	50	54	10	10,8	6,5
20309	1082212	65	76,1	15,9	16,7	10,6
20310	1082213	80	88,9	18,5	19,5	12,5
20311	1082214	100	108	23	24,1	15,5

Geberit Mapress El-Forsinket Stål passbend 90°

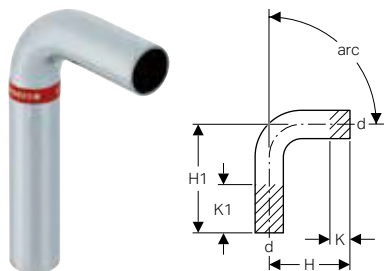

click & scan

Art. nr.	NRF nr.	DN	d, ø [mm]	arc [°]	H [cm]	H1 [cm]	K1 maks. [cm]
20401	1082306	10	12	90	4,8	11,9	7,1
20402	1082309	12	15	90	5,9	12,9	7
20403	1082313	15	18	90	6,1	13,3	7,2
20404	1082316	20	22	90	7	14,2	7,2
20405	1082319	25	28	90	7,9	15,5	7,6
20406	1082323	32	35	90	7,7	15,4	7,7
20407	1082326	40	42	90	9	18	9
20408	1082329	50	54	90	11,1	20,5	9,4



Geberit Mapress El-Forsinket Stål bypass-rør

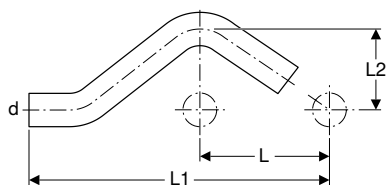

click & scan

Art. nr.	NRF nr.	DN	d, ø [mm]	L [cm]	L1 [cm]	L2 [cm]
20801	1083206	10	12	6	16,4	3,2
20802	1083209	12	15	6	16,5	3,2
20803	1083213	15	18	6	16,6	3,3
20804	1083216	20	22	6	16,8	3,5
20805	1083219	25	28	6	17,9	3,8

T-rør

Geberit Mapress El-Forsinket Stål T-rør likt

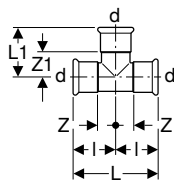

click & scan

Art. nr.	NRF nr.	DN	d, ø [mm]	arc [°]	L [cm]	L1 [cm]	I [cm]	Z [cm]	Z1 [cm]
21001	1082856	10	12	90	5,6	3,5	2,8	1,1	1,8
21002	1082859	12	15	90	6,4	3,9	3,2	1,2	1,9
21003	1082863	15	18	90	6,8	4,1	3,4	1,4	2,1
21004	1082866	20	22	90	7,4	4,4	3,7	1,6	2,3
21005	1082869	25	28	90	8,4	5	4,2	1,9	2,7
21006	1082873	32	35	90	10	5,7	5	2,4	3,1
21007	1082876	40	42	90	11,4	6,5	5,7	2,7	3,5
21008	1082879	50	54	90	13,8	7,7	6,9	3,4	4,2
21009	1082882	65	76,1	90	23	11	11,5	6,2	5,7
21010	1082883	80	88,9	90	26	12,7	13	7	6,7
21011	1082884	100	108	90	31	15,3	15,5	8	7,8

Geberit Mapress El-Forsinket Stål T-rør redusert

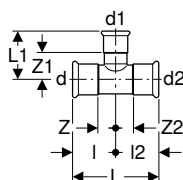

Art. nr.	NRF nr.	DN	d, ø [mm]	d1, ø [mm]	d2, ø [mm]	arc [°]	L [cm]	L1 [cm]	I [cm]	I2 [cm]	Z [cm]	Z1 [cm]	Z2 [cm]
21101	1083006	10 / 12 / 10	12	15	12	90	5,6	3,5	2,8	2,8	1,1	1,5	1,1
21201	1083863	12 / 10 / 10	15	12	12	90	7,2	3,6	3,2	4	1,2	1,9	2,3
21202	1082909	12 / 10 / 12	15	12	15	90	6,4	3,6	3,2	3,2	1,2	1,9	1,2
21103	1083009	12 / 15 / 12	15	18	15	90	6,4	3,6	3,2	3,2	1,2	1,6	1,2
21104	1083019	12 / 20 / 12	15	22	15	90	6,4	4,2	3,2	3,2	1,2	2,1	1,2
21203	1082913	15 / 10 / 15	18	12	18	90	6,8	3,8	3,4	3,4	1,4	2,1	1,4
21204	1082916	15 / 12 / 15	18	15	18	90	6,8	4,2	3,4	3,4	1,4	2,2	1,4
21105	1083013	15 / 20 / 15	18	22	18	90	6,8	4,1	3,4	3,4	1,4	2	1,4
21205	1082919	20 / 10 / 20	22	12	22	90	7,4	4	3,7	3,7	1,6	2,3	1,6
21206	1082923	20 / 12 / 20	22	15	22	90	7,4	4,4	3,7	3,7	1,6	2,4	1,6
21207	1082926	20 / 15 / 20	22	18	22	90	7,4	4,4	3,7	3,7	1,6	2,4	1,6
21107	1083016	20 / 25 / 20	22	28	22	90	7,4	4,5	3,7	3,7	1,6	2,2	1,6
21209	1082929	25 / 12 / 25	28	15	28	90	8,4	4,7	4,2	4,2	1,9	2,7	1,9
21210	1082933	25 / 15 / 25	28	18	28	90	8,4	4,7	4,2	4,2	1,9	2,7	1,9
21211	1082936	25 / 20 / 25	28	22	28	90	8,4	4,8	4,2	4,2	1,9	2,7	1,9
21212	1082939	32 / 12 / 32	35	15	35	90	10	5,1	5	5	2,4	3,1	2,4
21213	1082943	32 / 15 / 32	35	18	35	90	10	5,1	5	5	2,4	3,1	2,4
21214	1082946	32 / 20 / 32	35	22	35	90	10	5,2	5	5	2,4	3,1	2,4
21215	1082949	32 / 25 / 32	35	28	35	90	10	5,5	5	5	2,4	3,2	2,4
21216	1082951	40 / 12 / 40	42	15	42	90	11,4	5,3	5,7	5,7	2,7	3,3	2,7
21217	1082952	40 / 15 / 40	42	18	42	90	11,4	5,3	5,7	5,7	2,7	3,3	2,7
21218	1082953	40 / 20 / 40	42	22	42	90	11,4	5,5	5,7	5,7	2,7	3,4	2,7
21219	1082956	40 / 25 / 40	42	28	42	90	11,4	5,8	5,7	5,7	2,7	3,5	2,7
21220	1082959	40 / 32 / 40	42	35	42	90	11,4	6,1	5,7	5,7	2,7	3,5	2,7
21221	1082961	50 / 12 / 50	54	15	54	90	13,8	5,9	6,9	6,9	3,4	3,9	3,4
21222	1082962	50 / 15 / 50	54	18	54	90	13,8	5,9	6,9	6,9	3,4	3,9	3,4
21223	1082963	50 / 20 / 50	54	22	54	90	13,8	6,1	6,9	6,9	3,4	4	3,4
21224	1082966	50 / 25 / 50	54	28	54	90	13,8	6,4	6,9	6,9	3,4	4,1	3,4
21225	1082969	50 / 32 / 50	54	35	54	90	13,8	6,8	6,9	6,9	3,4	4,2	3,4
21226	1082973	50 / 40 / 50	54	42	54	90	13,8	7,2	6,9	6,9	3,4	4,2	3,4
21208		65 / 20 / 65	76,1	22	76,1	90	23	7,2	11,5	11,5	6,2	5,1	6,2
21230	1082975	65 / 25 / 65	76,1	28	76,1	90	23	7,5	11,5	11,5	6,2	5,2	6,2
21231	1082976	65 / 32 / 65	76,1	35	76,1	90	23	7,9	11,5	11,5	6,2	5,3	6,2
21232	1082977	65 / 40 / 65	76,1	42	76,1	90	23	8,3	11,5	11,5	6,2	5,3	6,2
21233	1082978	65 / 50 / 65	76,1	54	76,1	90	23	8,9	11,5	11,5	6,2	5,4	6,2
21236		80 / 20 / 80	88,9	22	88,9	90	26	7,8	13	13	7	5,7	7
21237	1082981	80 / 25 / 80	88,9	28	88,9	90	26	8,1	13	13	7	5,8	7
21238	1082982	80 / 32 / 80	88,9	35	88,9	90	26	8,5	13	13	7	5,9	7
21239	1082983	80 / 40 / 80	88,9	42	88,9	90	26	8,9	13	13	7	5,9	7
21240	1082984	80 / 50 / 80	88,9	54	88,9	90	26	9,5	13	13	7	6	7
21241	1082985	80 / 65 / 80	88,9	76,1	88,9	90	26	11,6	13	13	7	6,3	7
21244		100 / 20 / 100	108	22	108	90	31	8,8	15,5	15,5	8	6,7	8
21245	1082987	100 / 25 / 100	108	28	108	90	31	9,1	15,5	15,5	8	6,8	8
21246	1082988	100 / 32 / 100	108	35	108	90	31	9,5	15,5	15,5	8	6,9	8
21247	1082989	100 / 40 / 100	108	42	108	90	31	9,9	15,5	15,5	8	6,9	8
21248	1082991	100 / 50 / 100	108	54	108	90	31	10,5	15,5	15,5	8	7	8
21249	1082992	100 / 65 / 100	108	76,1	108	90	31	12,6	15,5	15,5	8	7,3	8
21250	1082993	100 / 80 / 100	108	88,9	108	90	31	13,7	15,5	15,5	8	7,7	8



Geberit Mapress El-Forsinket Stål T-rør med innvendige gjenger

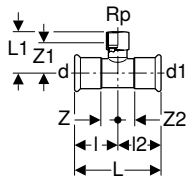

click & scan

Art. nr.	NRF nr.	DN	d, ø [mm]	Rp ["]	d1, ø [mm]	arc [°]	L [cm]	L1 [cm]	I [cm]	I2 [cm]	Z [cm]	Z1 [cm]	Z2 [cm]
21301	1083043	10	12	3/8"	12	90	5,6	3,3	2,8	2,8	1,1	2,3	1,1
21302	1083046	10 / 15 / 10	12	1/2"	12	90	5,6	3,6	2,8	2,8	1,1	2,3	1,1
21304	1083049	12 / 15 / 12	15	1/2"	15	90	6,4	3,7	3,2	3,2	1,2	2,4	1,2
21305	1083053	15	18	1/2"	18	90	6,8	3,9	3,4	3,4	1,4	2,6	1,4
21307	1083056	20 / 15 / 20	22	1/2"	22	90	7,4	4	3,7	3,7	1,6	2,7	1,6
21308	1083057	20 / 20 / 20	22	3/4"	22	90	7,4	4,4	3,7	3,7	1,6	2,8	1,6
21309	1083059	25 / 15 / 25	28	1/2"	28	90	8,4	4,4	4,2	4,2	1,9	3,1	1,9
21310	1083061	25 / 20 / 25	28	3/4"	28	90	8,4	4,7	4,2	4,2	1,9	3,2	1,9
21311	1083864	25	28	1"	28	90	8,4	5,3	4,2	4,2	1,9	3,6	1,9
21312	1083063	32 / 15 / 32	35	1/2"	35	90	10	4,8	5	5	2,4	3,5	2,4
21313	1083064	32 / 20 / 32	35	3/4"	35	90	10	5,1	5	5	2,4	3,6	2,4
21314	1083865	32 / 25 / 32	35	1"	35	90	10	5,6	5	5	2,4	3,9	2,4
21316	1083066	40 / 15 / 40	42	1/2"	42	90	11,4	5,1	5,7	5,7	2,7	3,8	2,7
21317	1083067	40 / 20 / 40	42	3/4"	42	90	11,4	5,4	5,7	5,7	2,7	3,9	2,7
21318	1083866	40 / 25 / 40	42	1"	42	90	11,4	6	5,7	5,7	2,7	4,3	2,7
21320	1083069	50 / 15 / 50	54	1/2"	54	90	13,8	5,7	6,9	6,9	3,4	4,4	3,4
21321	1083071	50 / 20 / 50	54	3/4"	54	90	13,8	6	6,9	6,9	3,4	4,5	3,4
21322	1083867	50 / 25 / 50	54	1"	54	90	13,8	6,6	6,9	6,9	3,4	4,9	3,4
21324	1083868	50	54	2"	54	90	13,8	7,9	6,9	6,9	3,4	5,6	3,4
21326	1083076	65 / 20 / 65	76,1	3/4"	76,1	90	23	7,4	11,5	11,5	6,2	5,9	6,2
21329	1083869	65 / 50 / 65	76,1	2"	76,1	90	23	9,1	11,5	11,5	6,2	6,8	6,2
21331	1083077	80 / 20 / 80	88,9	3/4"	88,9	90	26	8	13	13	7	6,5	7
21334	1083871	80 / 50 / 80	88,9	2"	88,9	90	26	9,7	13	13	7	7,4	7
21336	1083078	100 / 20 / 100	108	3/4"	108	90	31	9	15,5	15,5	8	7,5	8

Kryss

Geberit Mapress El-Forsinket Stål kryss redusert

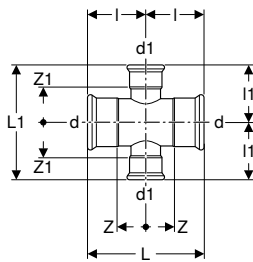

click & scan

Art. nr.	NRF nr.	DN	d, ø [mm]	d1, ø [mm]	arc [°]	L [cm]	L1 [cm]	I [cm]	I1 [cm]	Z [cm]	Z1 [cm]
21120	1083813	32 / 25	35	28	90	10	11	5	5,5	2,4	3,2
21121	1083814	40 / 25	42	28	90	11,4	11,6	5,7	5,8	2,7	3,5
21122	1083815	50 / 25	54	28	90	13,8	12,8	6,9	6,4	3,4	4,1
21123	1083816	50 / 32	54	35	90	13,8	13,6	6,9	6,8	3,4	4,2
21127	1083817	65 / 25	76,1	28	90	23	15,8	11,5	7,9	6,2	5,6
21128	1083818	65 / 32	76,1	35	90	23	16,2	11,5	8,1	6,2	5,5
21130	1083819	80 / 25	88,9	28	90	26	17,4	13	8,7	7	6,4
21131	1083821	80 / 32	88,9	35	90	26	18	13	9	7	6,4
21133	1083822	100 / 25	108	28	90	31	20	15,5	10	8	7,7
21134	1083823	100 / 32	108	35	90	31	20	15,5	10	8	7,4

Geberit Mapress El-Forsinket Stål kryss 30° redusert

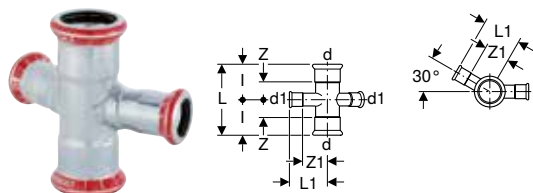

click & scan

Art. nr.	NRF nr.	DN	d, ø [mm]	d1, ø [mm]	arc [°]	L [cm]	L1 [cm]	l [cm]	Z [cm]	Z1 [cm]
21404	1083824	15 / 12	18	15	30	6,8	4	3,4	1,4	2
21406	1083825	20 / 12	22	15	30	7,4	4,2	3,7	1,6	2,2
21409	1083826	25 / 12	28	15	30	8,4	4,5	4,2	1,9	2,5

Geberit Mapress El-Forsinket Stål kryss redusert, forskjøvet

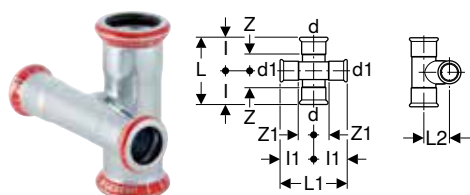

click & scan

Art. nr.	NRF nr.	DN	d, ø [mm]	d1, ø [mm]	arc [°]	L [cm]	L1 [cm]	L2 [cm]	l [cm]	l1 [cm]	Z [cm]	Z1 [cm]
21504	1083143	12	15	15	90	6,4	6,4	2	3,2	3,2	1,2	1,2
21505	1083146	15 / 12	18	15	90	6,8	8,4	2,3	3,4	4,2	1,4	2,2
21506	1083149	20 / 12	22	15	90	7,4	8,4	2,5	3,7	4,2	1,6	2,2
21509	1083153	20 / 15	22	18	90	7,4	8,4	2,6	3,7	4,2	1,6	2,2
21507	1083156	25 / 12	28	15	90	8,4	8,4	2,9	4,2	4,2	1,9	2,2
21510	1083159	25 / 15	28	18	90	8,4	8,4	3,2	4,2	4,2	1,9	2,2
21512	1083163	25 / 20	28	22	90	8,4	8,4	3,3	4,2	4,2	1,9	2,1

Overganger uløselige

Geberit FlowFit overgangsstykke til Geberit Mapress, med spissende

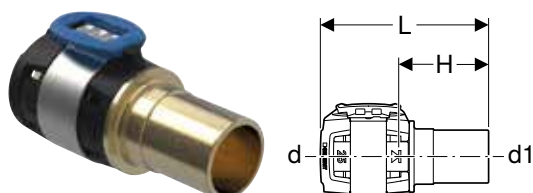

click & scan

Art. nr.	NRF nr.	DN	d, ø [mm]	d1, ø [mm]	L [cm]	H [cm]
620.230.00.1	2473605	12 / 10	16	12	6,8	3,5
620.240.00.1	2473606	12	16	15	6,9	3,6
620.231.00.1	2473607	15 / 12	20	15	6,9	3,6
620.241.00.1	2473615	15	20	18	6,9	3,6
620.242.00.1	2473608	15 / 20	20	22	7	3,7
620.232.00.1	2473609	20	25	22	7	3,7
620.233.00.1	2473611	25	32	28	7,7	4,1
620.234.00.1	2473612	32	40	35	8	4,4
620.235.00.1	2473613	40	50	42	12,8	6,9
620.236.00.1	2473614	50	63	54	13,8	7,5



Geberit Mepla overgangsstykke til Geberit Mapress, med spissende

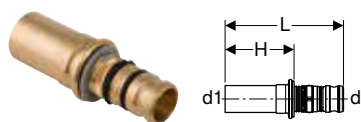

click & scan

Art. nr.	NRF nr.	DN	d, ø [mm]	d1, ø [mm]	L [cm]	H [cm]
601.507.00.5	2472922	12 / 10	16	12	5,8	3,3
601.508.00.5	2472241	12	16	15	5,9	3,4
602.507.00.5	2472248	15 / 12	20	15	6,1	3,4
602.508.00.5	2472242	15	20	18	6,1	3,4
602.509.00.5	2472923	15 / 20	20	22	6,2	3,5
603.508.00.5	2472243	20	26	22	6,7	3,5
604.508.00.5	2472244	25	32	28	6,6	3,7
605.508.00.5	2472245	32	40	35	7,5	4,1
606.508.00.5	2472246	40	50	42	10,1	6,3
607.508.00.5	2472247	50	63	54	13,6	7

Geberit Mapress El-Forsinket Stål overgangsstykke med innstikk- og sveisbar ende

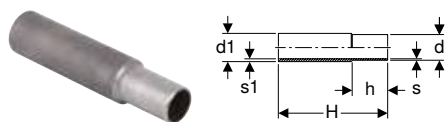

click & scan

Art. nr.	NRF nr.	DN	d, ø [mm]	d1, ø [mm]	s1 [mm]	s [mm]	H [cm]	h [cm]
12412	1081159	12	15	17,2	2,3	1,2	12	3
12413	1081163	15	18	21,3	2,9	1,2	12	3
12414	1081166	20	22	26,9	4	1,5	12	3,4
12415	1081169	25	28	33,7	4,4	1,5	12	3,4
12416	1081173	32	35	42,4	5,2	1,5	12	4
12417	1081176	40	42	48,3	4,7	1,5	12	4,5
12418	1081179	50	54	60,3	4,7	1,5	12	5
12419	1081187	65	76,1	76,1	3,7	2	12	7
12420	1081188	80	88,9	88,9	4,1	2	12	7,5
12421	1081189	100	108	114,3	5,2	2	12	9

Geberit Mapress El-Forsinket Stål overgangsstykke med utvendige gjenger



click & scan

Art. nr.	NRF nr.	DN	d, ø [mm]	R ["]	L [cm]	H [cm]
21701	1082586	10	12	3/8"	3,3	1,6
21700	1082587	10 / 15	12	1/2"	3,6	2,2
21702	1082589	12 / 10	15	3/8"	3,8	1,8
21703	1082593	12 / 15	15	1/2"	4,1	2,1
21714	1082594	12 / 20	15	3/4"	4,3	2,6
21704	1082596	15	18	1/2"	4,2	2,2
21705	1082599	15 / 20	18	3/4"	4,4	2,4
21715	1082601	20 / 15	22	1/2"	4	2,2
21707	1082603	20	22	3/4"	4,4	2,3
21716	1083831	20 / 25	22	1"	4,6	2,6
21717	1082605	25 / 20	28	3/4"	4,6	2,6
21708	1082606	25	28	1"	4,8	2,5
21727	1082607	25 / 32	28	1 1/4"	4,8	2,8
21719	1082604	32 / 25	35	1"	5,1	2,5
21709	1082609	32	35	1 1/4"	5,3	2,7
21720	1082611	32 / 40	35	1 1/2"	5,3	3
21721	1083832	40 / 32	42	1 1/4"	5,7	2,7
21710	1082613	40	42	1 1/2"	5,7	2,7
21722		50 / 40	54	1 1/2"	7,1	3,6
21711	1082616	50	54	2"	7,1	3,6
21713	1082617	65	76,1	2 1/2"	11,9	4,3
21724	1082618	80	88,9	3"	13,7	5
21725	1082619	100	108	4"	16	6,1

Geberit Mapress El-Forsinket Stål overgangsstykke med utvendige gjenger og spissende

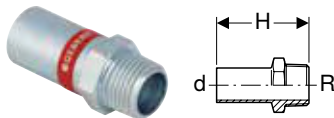

click & scan

Art. nr.	NRF nr.	DN	d, ø [mm]	R ["]	H [cm]
21930	1083835	10	12	3/8"	4,8
21931	1083836	10 / 15	12	1/2"	5,5
21932	1083837	12 / 15	15	1/2"	5,7
21933	1083838	15	18	1/2"	5,7
21934	1083839	15 / 20	18	3/4"	5,9
21935	1083841	20 / 15	22	1/2"	5,7
21936	1083842	20	22	3/4"	5,9
21937	1082894	25	28	1"	6,6
21938	1082895	32	35	1 1/4"	8
21939	1082896	40	42	1 1/2"	9,1
21940	1082897	50	54	2"	10,2



Geberit Mapress EI-Forsinket Stål overgangsstykke med innvendige gjenger

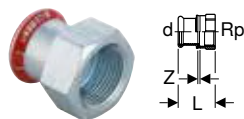

click & scan

Art. nr.	NRF nr.	DN	d, ø [mm]	Rp ["]	L [cm]	Z [cm]
21800	1082637	10	12	3/8"	3,1	0,3
21801	1082636	10 / 15	12	1/2"	3,4	0,4
21827	1082638	12 / 10	15	3/8"	3,3	0,3
21802	1082639	12 / 15	15	1/2"	3,7	0,4
21823	1082641	12 / 20	15	3/4"	3,8	0,7
21803	1082643	15	18	1/2"	3,7	0,4
21804	1082646	15 / 20	18	3/4"	3,8	0,3
21805	1082647	20 / 15	22	1/2"	3,8	0,3
21806	1082649	20	22	3/4"	3,9	0,3
21824	1082651	20 / 25	22	1"	4,2	0,4
21807	1082656	25 / 15	28	1/2"	3,8	0,2
21808	1082657	25 / 20	28	3/4"	3,8	0,1
21809	1082653	25	28	1"	4,4	0,4
21810	1082659	32 / 20	35	3/4"	4,2	0,1
21820	1083833	32 / 25	35	1"	4,5	0,2
21811	1082661	32	35	1 1/4"	4,9	0,4
21814	1082664	40	42	1 1/2"	5,3	0,4
21818	1082666	50	54	2"	6,2	0,5

Geberit Mapress EI-Forsinket Stål overgangsstykke med innvendige gjenger og spissende

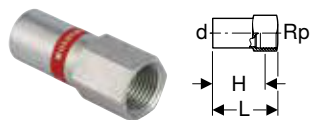

click & scan

Art. nr.	NRF nr.	DN	d, ø [mm]	Rp ["]	L [cm]	H [cm]
21907	1083834	10	12	3/8"	5,4	4,4
21901	1082676	10 / 15	12	1/2"	5,8	4,5
21908	1082681	12 / 10	15	3/8"	7,4	6
21902	1082679	12 / 15	15	1/2"	6,1	4,8
21903	1082683	15	18	1/2"	6,1	4,8
21904	1082686	15 / 20	18	3/4"	6,4	4,9
21905	1082689	20 / 15	22	1/2"	6,2	4,9
21906	1082693	20	22	3/4"	6,5	5
21910		25 / 15	28	1/2"	7,1	5,6
21914		40 / 15	42	1/2"	8,1	5,7
21916		50 / 15	54	1/2"	8,6	6,2
21918		65 / 15	76,1	1/2"	10,5	8,7
21920		80 / 15	88,9	1/2"	11,5	10,2
21922		100 / 15	108	1/2"	12,7	11,4

Geberit Mapress EI-Forsinket Stål albue 90° med utvendige gjenger

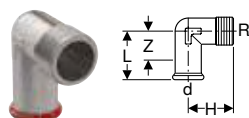

click & scan

Art. nr.	NRF nr.	DN	d, ø [mm]	R ["]	arc [°]	L [cm]	H [cm]	Z [cm]
21611	1083797	10	12	3/8"	90	3,2	2,5	1,5
21612	1083798	12 / 10	15	3/8"	90	3,6	2,6	1,6
21613	1083799	12 / 15	15	1/2"	90	3,5	3,1	1,5
21615	1083801	15	18	1/2"	90	3,7	3,1	1,7
21618	1083802	20	22	3/4"	90	4,1	3,5	2
21609	1082291	25 / 20	28	3/4"	90	5,8	5	3,5
21610	1082292	25	28	1"	90	5,8	5,4	3,5

Geberit Mapress El-Forsinket Stål albue 90° med innvendige gjenger

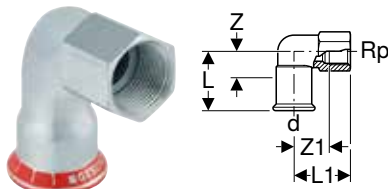

click & scan

Art. nr.	NRF nr.	DN	d, ø [mm]	Rp ["]	arc [°]	L [cm]	L1 [cm]	Z [cm]	Z1 [cm]
21659	1083803	20 / 15	22	1/2"	90	4,2	4	2,1	2,7
21660	1082264	25 / 15	28	1/2"	90	4,7	4,4	2,4	3,1
21661	1082266	25 / 20	28	3/4"	90	5,8	5	3,5	3,5
21662	1082267	25	28	1"	90	5,8	5,4	3,5	3,6

Geberit Mapress El-Forsinket Stål albue 90° med utvendige gjenger

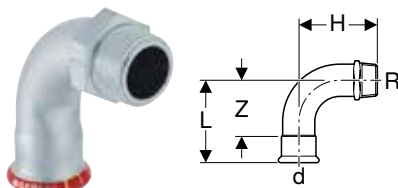

click & scan

Art. nr.	NRF nr.	DN	d, ø [mm]	R ["]	arc [°]	L [cm]	H [cm]	Z [cm]
20501	1082226	10	12	3/8"	90	4,2	3,4	2,5
20502	1082229	12 / 10	15	3/8"	90	4,9	3,7	2,9
20503	1082233	12 / 15	15	1/2"	90	4,9	4	2,9
20505	1082236	15	18	1/2"	90	5,3	4,7	3,3
20507	1082239	20	22	3/4"	90	6,1	5,4	4
20508	1082243	25	28	1"	90	7,2	6,6	4,9
23509	1082246	32	35	1 1/4"	90	6,8	9,8	4,2
23510	1082249	40	42	1 1/2"	90	8	11,3	5
23511	1082253	50	54	2"	90	10	13,8	6,5

Geberit Mapress El-Forsinket Stål albue 90° med innvendige gjenger

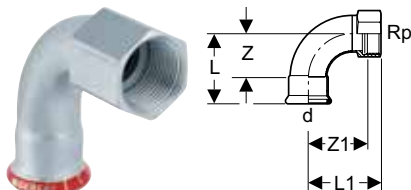

click & scan

Art. nr.	NRF nr.	DN	d, ø [mm]	Rp ["]	arc [°]	L [cm]	L1 [cm]	Z [cm]	Z1 [cm]
20551	1082145	10	12	3/8"	90	4,2	4,1	2,5	3
20552	1082146	12 / 10	15	3/8"	90	4,9	4,5	2,9	3,4
20553	1082147	12 / 15	15	1/2"	90	4,9	4,8	2,9	3,3
20555	1082148	15	18	1/2"	90	5,3	5,2	3,3	3,7
20557	1082149	20	22	3/4"	90	6,1	6	4	4,4
20558	1082151	25 / 15	28	1/2"	90	7,2	6,5	4,9	5
20559	1082152	25	28	1"	90	7,2	6,6	4,9	4,7
20560	1082153	32	35	1 1/4"	90	6,8	7,5	4,2	5,4
20561	1082154	40	42	1 1/2"	90	8	8,4	5	6,3
20562	1082155	50	54	2"	90	10	10,4	6,5	7,8



Overganger og forbindelser, løsbare

Geberit Mapress El-Forsinket Stål union



click & scan

Art. nr.	NRF nr.	DN	d, ø [mm]	G ["]	L [cm]	Z [cm]
25319	1083872	10	12	1/2"	5,8	2,1
25320	1083873	12	15	3/4"	6,6	2,6
25321	1083874	15	18	3/4"	6,9	2,9
25322	1083875	20	22	1"	7,2	3
25323	1083876	25	28	1 1/4"	7,7	3,1
25324	1083877	32	35	1 1/2"	8,2	3
25325	1083878	40	42	1 3/4"	9,5	3,5
25326	1083879	50	54	2 3/8"	11,3	4,3

Geberit Mapress El-Forsinket Stål union med utvendige gjenger



click & scan

Art. nr.	NRF nr.	DN	d, ø [mm]	R ["]	G ["]	L [cm]	H [cm]
25330	1083083	12 / 15	15	1/2"	3/4"	6,1	4,1
25332	1083084	15	18	1/2"	3/4"	6,1	4,1
25335	1083086	20	22	3/4"	1"	6,8	4,7
25329	1083087	20 / 25	22	1"	1"	6,9	4,8
25337	1083089	25	28	1"	1 1/4"	7,5	5,2
25338	1083093	32	35	1 1/4"	1 1/2"	8	5,4
25339	1083096	40	42	1 1/2"	1 3/4"	8,5	5,5
25340	1083099	50	54	2"	2 3/8"	9,7	6,2

Geberit Mapress El-Forsinket Stål union med innvendige gjenger

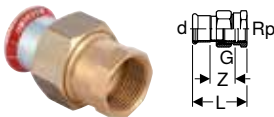

click & scan

Art. nr.	NRF nr.	DN	d, ø [mm]	Rp ["]	G ["]	L [cm]	Z [cm]
25300	1083102	12 / 15	15	1/2"	3/4"	5,8	2,3
25302	1083104	15	18	1/2"	3/4"	5,8	2,3
25304	1083106	20	22	3/4"	1"	6,3	2,3
25305	1083107	20 / 25	22	1"	1"	6,6	3
25306	1083109	25	28	1"	1 1/4"	7,1	3,3
25307	1083112	32	35	1 1/4"	1 1/2"	7,7	3,5
25308	1083114	40	42	1 1/2"	1 3/4"	8,2	3,1
25309	1083116	50	54	2"	2 3/8"	9,5	3,4

Geberit Mapress El-Forsinket Stål overgangsstykke med unionmutter

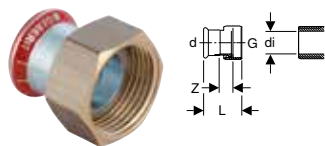

click & scan

Art. nr.	NRF nr.	DN	d, ø [mm]	G ["]	di, ø [mm]	L [cm]	Z [cm]
25032	1083233	12	15	3/4"	13	3,7	1,1
25033	1083236	15	18	3/4"	13	3,7	1,1
25034	1083239	20	22	1"	20	4	1,1
25035	1083243	25	28	1 1/4"	26	4,4	1,3
25036	1083246	32	35	1 1/2"	32	4,8	1,3
25037	1083249	40	42	1 3/4"	39	5,2	1,3
25038	1083253	50	54	2 3/8"	51	5,8	1,5
25045	1083254	65	76,1	3"	73	9,9	3,3
25046	1083255	80	88,9	3 1/2"	84	11,1	3,7

Geberit Mapress-overgang med kompresjonsringmontering for bølgerør, NPW, innsettsende

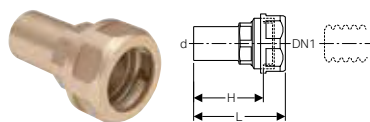

click & scan

Art. nr.	DN	DN1	d, ø [mm]	L [cm]	H [cm]	PN [bar]
22421	12	16	15	6,4	4,9	10
22431	12	20	15	6,7	5,2	10
22422	15	16	18	6,4	4,9	10
22432	15	20	18	6,7	5,2	10
22423	20	16	22	6,8	5,9	10
22433	20	20	22	6,8	5,9	10
22444	25	25	28	6,8	5,9	10



- Hvis skruelingen og bølgerøret har ulikt driftstrykk, er det laveste driftstrykket retningsgivende

Geberit Mapress C-stålflens PN 6, med muffe

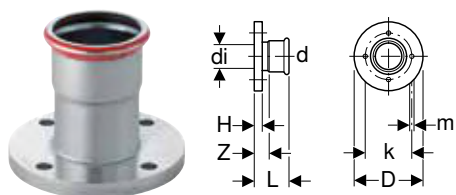

click & scan

Art. nr.	DN	d, ø [mm]	di, ø [mm]	D [cm]	k [mm]	m [mm]	L [cm]	H [cm]	Z [cm]	n [pc.]	PN [bar]	
23722	I	20	22	19	9	65	11	6,1	1,4	4	4	6
23723	I	25	28	25	10	75	11	6,5	1,4	4,2	4	6
23724	I	32	35	32	12	90	14	7	1,6	4,4	4	6
23725	I	40	42	39	13	100	14	7,7	1,6	4,7	4	6
23726	I	50	54	51	14	110	14	8,5	1,6	5	4	6
23727	I	65	76,1	72,4	16	130	14	12,4	1,6	7,1	4	6
23728	I	80	88,9	85,2	19	150	18	14,1	1,8	8,1	4	6
23729	I	100	108	104,3	21	170	18	16,6	1,8	9,6	4	6

I: I ferd med å utløpe



Geberit Mapress El-Forsinket Stål flens PN 10/16, med muffe

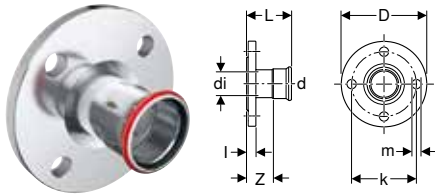

click & scan

Art. nr.	NRF nr.	DN	d, ø [mm]	di, ø [mm]	D [cm]	k [mm]	m [mm]	L [cm]	l [cm]	Z [cm]	n [pc.]	PN [bar]
23754	1082331	20	22	19	10,5	75	14	6,5	1,8	4,4	4	10 / 16
23755	1082332	25	28	25	11,5	85	14	6,9	1,8	4,6	4	10 / 16
23756	1082333	32	35	32	14	100	18	7,2	1,8	4,6	4	10 / 16
23757	1082334	40	42	39	15	110	18	7,9	1,8	4,9	4	10 / 16
23758	1082335	50	54	51	16,5	125	18	8,7	1,8	5,2	4	10 / 16
23759	1082336	65	76,1	72	18,5	145	18	11,8	1,8	6,5	4	10 / 16
23760	1082337	80	88,9	84,8	20	160	18	12,5	2	6,5	8	10 / 16
23761	1082338	100	108	103,9	22	180	18	13	2	5,5	8	10 / 16

Geberit Mapress C-stålflens PN 6, med innsettsende

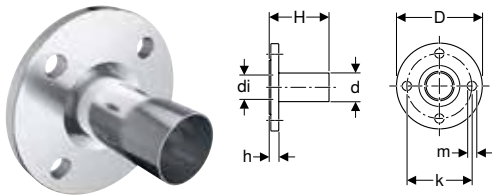

click & scan

Art. nr.	DN	d, ø [mm]	di, ø [mm]	D [cm]	k [mm]	m [mm]	H [cm]	h [cm]	n [pc.]	PN [bar]
23764	20	22	19	9	65	11	7,5	1,4	4	6
23765	25	28	25	10	75	11	7,7	1,4	4	6
23766	32	35	32	12	90	14	8,6	1,4	4	6
23767	40	42	39	13	100	14	10,4	1,4	4	6
23768	50	54	51	14	110	14	10,9	1,4	4	6
23769	65	76,1	72	16	130	14	13,2	1,4	4	6
23770	80	88,9	84,8	19	150	18	14,8	1,6	4	6
23771	100	108	103,9	21	170	18	16,1	1,6	4	6

Geberit Mapress El-Forsinket Stål flens PN 10/16, med innstikkende

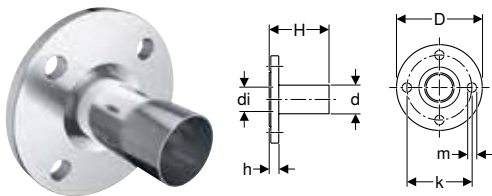

click & scan

Art. nr.	NRF nr.	DN	d, ø [mm]	di, ø [mm]	D [cm]	k [mm]	m [mm]	H [cm]	h [cm]	n [pc.]	PN [bar]
23784	1083804	20	22	19	10,5	75	14	7,9	1,8	4	10 / 16
23785	1083805	25	28	25	11,5	85	14	8,1	1,8	4	10 / 16
23786	1083806	32	35	32	14	100	18	9	1,8	4	10 / 16
23787	1083807	40	42	39	15	110	18	10,8	1,8	4	10 / 16
23788	1083808	50	54	51	16,5	125	18	11,3	1,8	4	10 / 16
23789	1083809	65	76,1	72	18,5	145	18	13,6	1,8	4	10 / 16
23790	1083811	80	88,9	84,8	20	160	18	15,2	2	8	10 / 16
23791	1083812	100	108	103,9	22	180	18	16,5	2	8	10 / 16

Kompensatorer

Geberit Mapress El-Forsinket Stål aksialkompensator med muffer

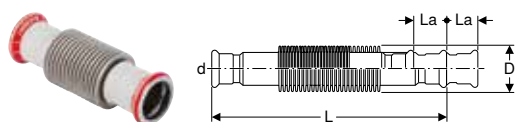

click & scan

Art. nr.	NRF nr.	DN	d, ø [mm]	D [cm]	La [mm]	L [cm]
23932	1082339	12	15	2,6	7	15,1
23933	1082341	15	18	2,6	7	14,7
23934	1082342	20	22	3,1	11	10,6
23935	1082343	25	28	3,9	13	12
23936	1082344	32	35	4,6	13	13,9
23937	1082345	40	42	5,9	13	14,9
23938	1082346	50	54	7	18	17,6
23939	1082347	65	76,1	8,8	22	26,2
23940	1082348	80	88,9	11,7	23	28,6
23941	1082349	100	108	14,4	23	54,2

Endedeksler

Geberit Mapress El-Forsinket Stål kappe



click & scan

Art. nr.	NRF nr.	DN	d, ø [mm]	L [cm]	Z [cm]
20211	1083419	10	12	2	0,3
20212	1083421	12	15	2,3	0,3
20213	1083422	15	18	2,3	0,3
20214	1083423	20	22	2,4	0,3
20215	1083424	25	28	2,6	0,3
20216	1083425	32	35	2,9	0,3
20217	1083426	40	42	3,3	0,3
20218	1083427	50	54	3,8	0,3
20219	1083428	65	76,1	6	0,7
20220	1083429	80	88,9	6,7	0,7
20221	1083431	100	108	8,2	0,7

Tilkoblinger for varme

Geberit Mapress El-Forsinket Stål T-koplingsstykke for tur og retur, langt

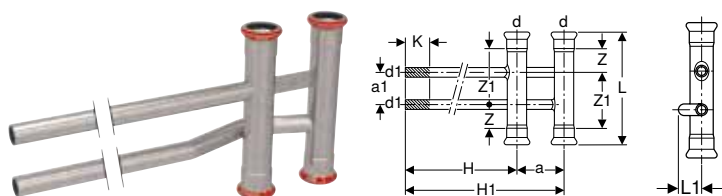

click & scan

Art. nr.	NRF nr.	DN	d, ø [mm]	d1, ø [mm]	arc [°]	a [cm]	a1 [cm]	L [cm]	L1 [cm]	H [cm]	H1 [cm]	Z [cm]	Z1 [cm]
22951	1083854	12 / 10	15	12	90	6	4	14	2,1	50	56	3	7
22952	1083855	12 / 12	15	15	90	6	4	14	2,4	50	56	3	7
22953	1083856	15 / 10	18	12	90	6	4	14	2,2	50	56	3	7
22954	1083857	15 / 12	18	15	90	6	4	14	2,5	50	56	3	7
22955	1083858	20 / 10	22	12	90	6	4	14	2,4	50	56	2,9	6,9
22956	1083859	20 / 12	22	15	90	6	4	14	2,7	50	56	2,9	6,9
22958	1083861	25 / 12	28	15	90	6	4	14	3	50	56	2,7	6,7

Geberit Mapress El-Forsinket Stål sett T-koplingsstykke for tur og retur

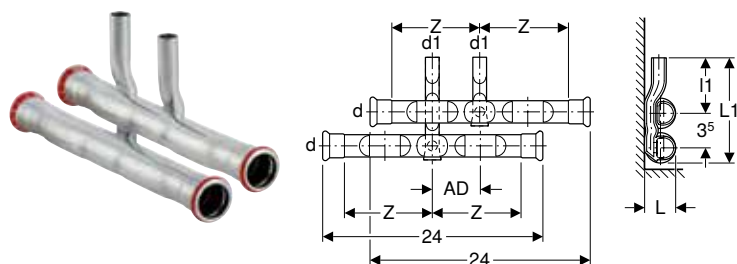

click & scan

Art. nr.	NRF nr.	DN	d, ø [mm]	d1, ø [mm]	arc [°]	AD min. [cm]	L [cm]	L1 [cm]	l1 [cm]	Z [cm]
24002	1083349	12	15	15	90	4-6	2,7	10,8	6,5	10
24003	1083353	15 / 12	18	15	90	4-6	2,9	11	6,5	10
24004	1083356	20 / 12	22	15	90	4-6	3,3	11,2	6,5	10

Tilbehør for Geberit Mapress El-Forsinket Stål

Beskyttelse for rør og fittings

Geberit beskyttelsestape

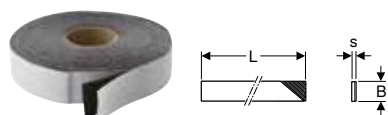

click & scan

Art. nr.	NRF nr.	s [mm]	L [m]	B [cm]
601.813.00.1	2472901	1	12,5	3
601.815.00.1	2472902	1	12,5	5

- i** • Sett på etter trykkontroll

Klammer for rør

Geberit gjengestag

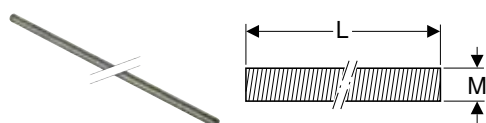

click & scan

Art. nr.	NRF nr.	Farge / overflate	M [mm]	L [cm]
362.834.26.1	2290088	El-forsinket	10	200

Geberit bunnplate rektangulær, to hull, med gjenget rørmuffe M8/M10

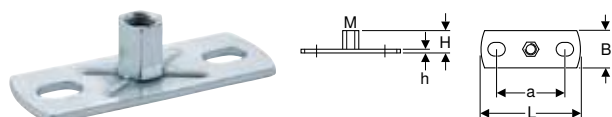

click & scan

Art. nr.	NRF nr.	M [mm]	a [cm]	L [cm]	B [cm]	H [cm]	h [cm]
362.848.26.1	2290373	8 / 10	5,4	8	3	1,9	0,3



Geberit bunnplate rektangulær, to hull, med gjenget rørmuffe M10 / G 1/2"

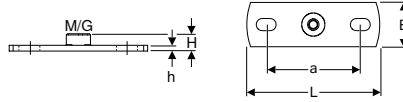

click & scan

Art. nr.	NRF nr.	G ["]	M [mm]	a [cm]	L [cm]	B [cm]	H [cm]	h [cm]
362.851.26.1	2290374	1/2"	10	8,5	12	4	1,5	0,5

Systempakninger

Geberit Mapress tetningsring CIIR svart



click & scan

Art. nr.	NRF nr.	DN	d, ø [mm]
90401	1952142	10	12
90402	1952144	12	15
90403	1952146	15	18
90404	1952148	20	22
90405	1952151	25	28
90406	1952153	32	35
90407	1952155	40	42
90408	1952157	50	54
90409	1952159	65	76,1
90410	1952162	80	88,9
90411	1952164	100	108

Geberit Mapress tetningsring FKM blå



click & scan

Art. nr.	NRF nr.	DN	d, ø [mm]
90881	1952001	10	12
90882	1952003	12	15
90883	1952005	15	18
90884	1952007	20	22
90885	1952009	25	28
90886	1952012	32	35
90887	1952014	40	42
90888	1952016	50	54
90891	1952018	65	76,1
90892	1952021	80	88,9
90893	1952023	100	108

Geberit Mapress planpakning EPDM svart

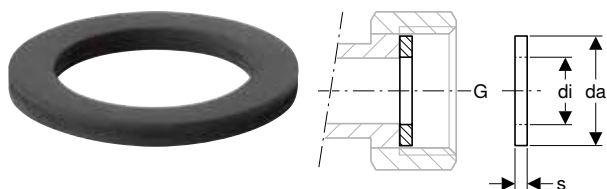

click & scan

Art. nr.	NRF nr.	G ["]	da [mm]	di, ø [mm]	s [mm]
90080	1952243	1/2"	18	10	2
90081	1952244	3/4"	24	13	2
90082	1952245	1"	30	19,6	2
90083	1952246	1 1/4"	39	25,6	2
90084	1952247	1 1/2"	45	32	2
90085	1952248	1 3/4"	50	39	2
90086	1952249	2 3/8"	66	51	3
90088		3"	84,7	76	3
90089		3 1/2"	97	84	3

Geberit Mapress planpakning FPM grønn

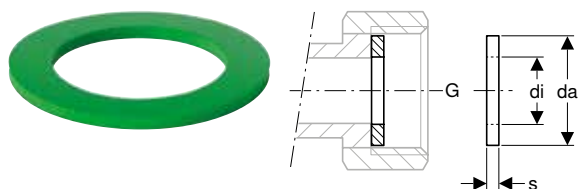

click & scan

Art. nr.	NRF nr.	G ["]	da [mm]	di, ø [mm]	s [mm]
90092	1952225	3/4"	24	13	2
90094	1952227	1"	30	19,6	2
90095	1952228	1 1/4"	39	25,6	2
90096	1952229	1 1/2"	45	32	2
90097	1952231	1 3/4"	50	39	2
90098	1952232	2 3/8"	66	51	2



Ny

Geberit Mapress planpakning fiberkomposittmateriale



click & scan

Art. nr.	G ["]	da [mm]	di, ø [mm]	s [mm]
600.079.00.1	1/2"	18,4	10	2
600.080.00.1	3/4"	23,9	13	2
600.081.00.1	1"	30	19,6	2
600.082.00.1	1 1/8"	34,7	21	2
600.083.00.1	1 1/4"	38	25	2
600.084.00.1	1 1/4"	38,7	25,6	2
600.085.00.1	1 1/2"	44,6	32	2
600.087.00.1	1 3/4"	50,5	39	2
600.088.00.1	2"	56,4	42	2
600.089.00.1	2 1/4"	62,5	42	2
600.090.00.1	2 3/8"	66,2	51	2
600.091.00.1	2 1/2"	72	54	2
600.092.00.1	2 3/4"	78,3	57	2
600.093.00.1	3"	84,7	72,1	2
600.094.00.1	3 1/2"	97,1	84,9	2

Kan leveres fra april 2024



- Erstatning for art. nr. 600.021.00.1, 600.022.00.1, 90072, 600.023.00.1, 90074, 600.024.00.1, 90075, 600.025.00.1, 600.026.00.1, 90076, 600.027.00.1, 90077, 600.028.00.1, 600.029.00.1, 600.030.00.1, 90078, 600.031.00.1, 600.032.00.1, 600.033.00.1, 600.034.00.1



Geberit Mapress Syrefast Stål



Bruksoversikt – Geberit Mapress Syrefast Stål for flytende medier	35
Bruksoversikt – Geberit Mapress Syrefast Stål for gassmedier	35
Målendringer Geberit Mapress syrefast stål april 2023 til april 2024.....	36
Geberit Mapress Syrefast Stål.....	36
Systemrør 1.4401	36
Rørnippel.....	37
Muffer.....	37
Reduksjoner.....	38
Bend	39
T-stykker.....	42
Innvendig sirkulasjon.....	45
Overganger uløselige	45
Overganger og forbindelser, løsbare	50
Kompensatorer	55
Gjennomføringer	55
Endedeksler.....	56
Tilkoblinger	56
Geberit Mapress Syrefast Stål, gass	57
Systemrør 1.4401	57
Rørnippel.....	57
Muffer.....	58
Reduksjoner.....	59
Bend	59
T-stykker.....	62
Overganger uløselige	63
Overganger og forbindelser, løsbare	66
Endedeksler.....	68
Tilkoblinger	68
Tilbehør til Geberit Mapress Syrefast Stål.....	68
Beskyttelse for rør og fittings	68
Klammer for rør	69
Systempakninger	69

Bruksoversikt – Geberit Mapress Syrefast Stål for flytende medier

Geberit Norge, Versjon: oktober 2023

Bruksformål	Driftstemperatur	Maximum operating pressure	Rør			Fittings	
			CrNiMo-stål 1.4401/316	CrMoTi-stål 1.4521/444	CrNi-stål 1.4301/304	Rustfritt stål blå indikator	Rødgods hvit indikator
For drikkevann kaldt og varmt	0–100 °C	16 bar / 1600 kPa ⁴⁾	✓	✓		✓	✓
Til avkjøling og oppvarming av vann uten frostvæske	0–100 °C	16 bar / 1600 kPa	✓	✓	✓	✓	✓
Til avkjøling og oppvarming av vann med frostvæske	-30 – +120 °C ¹⁾	16 bar / 1600 kPa	✓	✓	✓	✓	✓
For fjernvarmeoppvarmingsvann ≤ 120 °C	0–120 °C	16 bar / 1600 kPa	✓	✓	✓	✓	✓
For fjernvarmeoppvarmingsvann ≤ 140 °C	0–140 °C	16 bar / 1600 kPa	✓	✓	✓	✓	✓
For mettet damp ≤ 120 °C	0–120 °C	2 bar/200 kPa	✓			✓	
For mettet damp ≤ 155 °C	0–155 °C	4.5 bar / 450 kPa	✓			✓	
For industri- og prosessvann	0–100 °C	16 bar / 1600 kPa	6)	6)		6)	
For ultrarent vann	0–100 °C	16 bar / 1600 kPa	✓ ⁷⁾	✓ ⁷⁾		✓ ⁷⁾	
For regnvann med pH-verdi > 6,0	0–100 °C	16 bar / 1600 kPa	✓	✓		✓	
For forbruks- og svartvann med pH-verdi > 6,0	0–100 °C	16 bar / 1600 kPa	✓	✓		✓	
For slukningsvann (vått)	0–100 °C	16 bar / 1600 kPa	✓			✓	
For slukningsvann (vått/tørt, tørt)	0–100 °C	16 bar / 1600 kPa	✓			✓	
For sprinkler (våt)	0–100 °C	16/10 bar ⁵⁾ 1600/1000 kPa	✓			✓	
For sprinkler (vått/tørt, tørt)	0–100 °C	16/10 bar ⁵⁾ 1600/1000 kPa	✓			✓	
For varmebærer (sol)	-25 – +220 °C ^{2) 3)}	16 bar / 1600 kPa	✓	✓	✓	✓	✓
For mineral- og smøreolje	Ved forespørsel	Ved forespørsel	6)			6)	
For drivstoff (f.eks. diesel)	Ved forespørsel	Ved forespørsel	6)			6)	
For kjemikalier og tekniske væsker	Ved forespørsel	Ved forespørsel	6)			6)	

✓ Bruk er generelt godkjent når de definerte tilleggskravene iht. fotnotene er oppfylt

- ¹⁾ Bruk av hemmere, antikorrosjonsmidler, frostvæske bare etter godkjenning av Geberit
- ²⁾ Levetid med kollektorstopp: 200 t/a ved 180 °C, 60 t/a ved 200 °C, total 500 t/levetid ved 220 °C
- ³⁾ Bruk av hemmere, anti korrosjonsmidler, frostvæske bare etter godkjenning av Geberit
- ⁴⁾ 10 bar / 1000 kPa for MasterFix og MeplaFix
- ⁵⁾ 16 bar / 1600 kPa til d22–76,1 mm, 10 bar / 1000 kPa til d88,9–108 mm
- ⁶⁾ Etter godkjenning fra Geberit
- ⁷⁾ Bruksområde i henhold til teknisk informasjon (TI) "Bearbeidet vann"
- ⁸⁾ Bruk bare fittings med unionmutter av CrNi-stål



- For hver bruk må driftsbetingelsene i de retningsgivende tillatelsene, normene og tekniske regelverkene overholdes. Disse kan avvike fra angivelsene ovenfor.

Bruksoversikt – Geberit Mapress Syrefast Stål for gassmedier

Geberit Norge, Versjon: oktober 2023

Bruksformål	Driftstemperatur	Maximum operating pressure	Rør			
			CrNiMo-stål 1.4401/316	CrMoTi-stål 1.4521/444	CrNi-stål 1.4301/304	CrTi-stål 1.4510 / 439
For trykkluft (renhetsklasse olje 0–3)	0–100 °C	25/16/12 bar 2500/1600/1200 kPa	✓ ³⁾	✓ ³⁾	✓ ³⁾	✓ ³⁾
For trykkluft (renhetsklasse olje 0–X)	0–100 °C	25/16/12 bar 2500/1600/1200 kPa	✓ ³⁾	✓ ³⁾	✓ ³⁾	✓ ³⁾
For undertrykk ¹⁾	0–100 °C	Abs. ≥ 0,2 bar/20 kPa	✓	4)	4)	4)
For inertgasser (f.eks. nitrogen)	0–100 °C	25/16/12 bar 2500/1600/1200 kPa	✓ ³⁾	✓ ³⁾	✓ ³⁾	✓ ³⁾
For industrigasser (f.eks. acetylen, sveisedekkgasser)	Ved forespørsel	Ved forespørsel	4)			
For naturgass	-20 – +70 °C	MOP 5 / GT 5 ²⁾	✓			
For flytende gass	-20 – +70 °C	MOP 5 / GT 5 ²⁾	✓			
For biogasser	Ved forespørsel	Ved forespørsel	4)			

✓ Bruk er generelt godkjent når de definerte tilleggskravene iht. fotnotene er oppfylt

- ¹⁾ Utnyttbart undertrykk for Geberit rørledningssystemer:
Utnyttbart undertrykk fremgår av lufttrykket på installasjonsstedet minus absoluttrykket fra 200 mbar.
Eksempel: 980 mbar lufttrykk – 200 mbar absoluttrykk = 780 mbar utnyttbart undertrykk i rørledningssystemet
- ²⁾ GT 0,1, hvis en gjenge > 2"
- ³⁾ 25 bar / 2500 kPa for d12–54 mm (d35–54mm only with pressing collars), 16 bar / 1600 kPa for d76.1 mm, 12 bar / 1200 kPa für d88.9–108 mm
- ⁴⁾ Etter godkjenning fra Geberit
- ⁵⁾ Renhetsklasse olje iht. ISO 8573-1:2010E; du finner informasjon om fuktighet og partikler i teknisk informasjon "Geberit rørledningssystemer for trykkluftinstallasjoner"



- For hver bruk må driftsbetingelsene i de retningsgivende tillatelsene, normene og tekniske regelverkene overholdes. Disse kan avvike fra angivelsene ovenfor.



	Tetningsringer				Planpakninger for skrueforbindelser			Flenspakninger
	CIIR svart	FKM blå	FKM hvit	FPM rød	EPDM svart	FPM grønn	Fiberkomposittmateriale	Fiberkomposittmateriale
	✓				✓		✓	✓
	✓ ¹⁾				✓ ¹⁾		✓	✓
	✓ ¹⁾						✓ ⁸⁾	✓
	✓ ¹⁾					✓	✓ ⁸⁾	✓
		✓ ¹⁾					✓ ⁸⁾	✓
	✓ ¹⁾						✓ ⁸⁾	✓
			✓ ¹⁾				✓ ⁸⁾	✓
	6)				6)		6)	6)
	✓ ⁷⁾				✓ ⁷⁾		✓ ⁷⁾	✓ ⁷⁾
	✓				✓		✓	✓
	✓				✓		✓	✓
	✓				✓		✓	✓
		✓		✓		✓	✓	✓
	✓				✓		✓	✓
		✓		✓		✓	✓	✓
		✓				✓	✓ ⁸⁾	✓
		6)				6)	6)	6)
		6)				6)	6)	6)
	6)	6)			6)	6)	6)	6)

	Fittings	Tetningsringer			Planpakninger for skrueforbindelser			Flenspakninger
	Rustfritt stål blå indikator	CIIR svart	FKM blå	HNBR gul	EPDM svart	FPM grønn	Fiberkomposittmateriale	Fiberkomposittmateriale
	✓	✓ ⁵⁾			✓ ⁵⁾		✓	✓
	✓		✓ ⁵⁾			✓ ⁵⁾	✓	✓
	✓	✓					✓	✓
	✓	✓			✓		✓	✓
	4)	4)					4)	4)
	✓			✓			✓	✓
	✓			✓			✓	✓
	4)			4)			4)	4)

Måleendringer Geberit Mapress syrefast stål april 2023 til april 2024

Geberit Norge, Versjon: oktober 2023

		arc/vinkel (°)	DN	d, ø	L	H	Z
Geberit Mapress Syrefast Stål bend	30101	90°	10	12 mm	3.1 cm		1.4 cm
	30102	90°	12	15 mm	3.8 cm		1.8 cm
	30104	90°	20	22 mm	4.7 cm		2.6 cm
Geberit Mapress Syrefast Stål bend (gass)	34000	90°	12	15 mm	3.8 cm		1.8 cm
	34002	90°	20	22 mm	4.7 cm		2.6 cm
Geberit Mapress Syrefast Stål bend med spissende	30301	90°	10	12 mm	3.1 cm	4.5 cm	1.4 cm
	30302	90°	12	15 mm	3.8 cm	4.8 cm	1.8 cm
	30303	90°	15	18 mm	4.2 cm	5.2 cm	2.2 cm
	30304	90°	20	22 mm	4.7 cm	5.8 cm	2.6 cm
Geberit Mapress Syrefast Stål bend med spissende (gass)	34007	90°	12	15 mm	3.8 cm	4.8 cm	1.8 cm
	34008	90°	15	18 mm	4.2 cm	5.2 cm	2.2 cm
	34009	90°	20	22 mm	4.7 cm	5.8 cm	2.6 cm



- Mellom april 2023 og april 2024 kommer artiklene som er oppført over, til å få nye mål iht. tabell. Artikler som har de nye målene, kommer til å bli merket med en X i tillegg på etiketten

Geberit Mapress Syrefast Stål

Systemrør 1.4401

Geberit Mapress systemrør i syrefast stål, CrNiMo

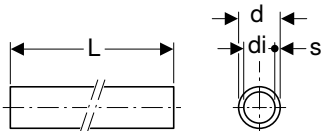
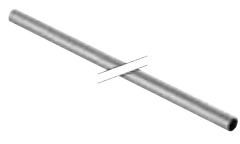

click & scan

Art. nr.	NRF nr.	DN	d, ø [mm]	di, ø [mm]	s [mm]	L [m]
39012		10	12	10	1	6
39002	1950006	12	15	13	1	6
39003	1950009	15	18	16	1	6
39004	1950016	20	22	19,6	1,2	6
39005	1950019	25	28	25,6	1,2	6
39006	1950023	32	35	32	1,5	6
39007	1950026	40	42	39	1,5	6
39008	1950029	50	54	51	1,5	6
39009	1950063	65	76,1	72,1	2	6
39010	1950066	80	88,9	84,9	2	6
39011	1950069	100	108	104	2	6

Tilbehør

- Geberit Mapress rørkutter R → s. 291
- Geberit Mapress avgrader → s. 292
- Geberit Mapress merkeal med merkepenn → s. 292

Rørnippel

Geberit Mapress Syrefast Stål rørnippel

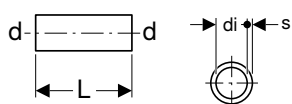

click & scan

Art. nr.	DN	d, ø [mm]	di, ø [mm]	s [mm]	L [cm]
32050	12	15	13	1	5
32051	15	18	16	1	5
32052	20	22	19,6	1,2	5,2
32053	25	28	25,6	1,2	5,6
32054	32	35	32	1,5	6,2
32055	40	42	39	1,5	8
32056	50	54	51	1,5	9
32057	65	76,1	72,1	2	13,6
32058	80	88,9	84,9	2	15
32059	100	108	104	2	18

Muffer

Geberit Mapress Syrefast Stål muffer

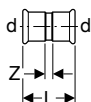

click & scan

Art. nr.	NRF nr.	DN	d, ø [mm]	L [cm]	Z [cm]
33001		10	12	4,2	0,8
32002	1950649	12	15	4,8	0,8
32003	1950653	15	18	4,8	0,8
32004	1950656	20	22	5	0,8
32005	1950659	25	28	5,4	0,8
32006	1950663	32	35	6,2	1
32007	1950666	40	42	7,1	1,1
32008	1950669	50	54	8,3	1,3
32009	1950683	65	76,1	12,7	2,1
32010	1950686	80	88,9	14,5	2,5
32011	1950689	100	108	17,6	2,6

Geberit Mapress Syrefast Stål glidemuffer

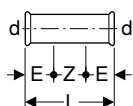

click & scan

Art. nr.	NRF nr.	DN	d, ø [mm]	E [cm]	L [cm]	Z [cm]
32101		10	12	2,5	6,7	1,7
32102	1950709	12	15	2,5	8	3
32103	1950713	15	18	2,5	8	3
32104	1950716	20	22	2,5	8,4	3,4
32105	1950719	25	28	3	9,1	3,1
32106	1950723	32	35	3	10,2	4,2
32107	1950726	40	42	4	12	4
32108	1950729	50	54	4	14	6
32109	1950733	65	76,1	6	23	11
32110	1950736	80	88,9	7	26	12
32111	1950739	100	108	8	31	15

Reduksjoner

Geberit Mapress Syrefast Stål reduksjon med spissende

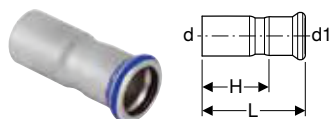

click & scan

Art. nr.	NRF nr.	DN	d, ø [mm]	d1, ø [mm]	L [cm]	H [cm]
33002		12 / 10	15	12	5,1	3,4
33003		15 / 10	18	12	5,3	3,6
32303	1950856	15 / 12	18	15	5,5	3,5
33004		20 / 10	22	12	6	4,3
32305	1950859	20 / 12	22	15	5,9	3,9
32306	1950864	20 / 15	22	18	5,7	3,7
32307	1950863	25 / 12	28	15	6,6	4,6
32308	1950865	25 / 15	28	18	6,4	4,4
32309	1950866	25 / 20	28	22	6	3,9
32310	1950868	32 / 12	35	15	7,5	5,5
32311	1950867	32 / 15	35	18	7,4	5,4
32312	1950869	32 / 20	35	22	7,1	5
32313	1950873	32 / 25	35	28	6,8	4,5
32314	1950874	40 / 12	42	15	8,1	6,1
32315	1950872	40 / 15	42	18	8	6
32316	1950875	40 / 20	42	22	8,2	6,1
32317	1950877	40 / 25	42	28	8,3	6
32318	1950876	40 / 32	42	35	7,7	5,1
32319	1950878	50 / 12	54	15	9,7	7,7
32320	1950884	50 / 15	54	18	9,6	7,6
32321	1950881	50 / 20	54	22	9,5	7,4
32322	1950882	50 / 25	54	28	11	8,7
32323	1950883	50 / 32	54	35	10,6	8
32324	1950879	50 / 40	54	42	9,2	6,2
32331	1950893	65 / 50	76,1	54	14,6	11,1
32338	1950894	80 / 50	88,9	54	16,2	12,8
32339	1950896	80 / 65	88,9	76,1	16,1	10,8
32345	1950897	100 / 50	108	54	17,2	13,7
32346	1950898	100 / 65	108	76,1	18,4	13,1
32348	1950899	100 / 80	108	88,9	20,3	14,3

Bend

Geberit Mapress Syrefast Stål bend

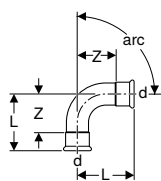

click & scan

Art. nr.	NRF nr.	DN	d, ø [mm]	L [cm]	Z [cm]
arc / Vinkel: 15°					
36101	1952262	12	15	3	1
36103	1952263	20	22	3,2	1,1
36104	1952264	25	28	3,6	1,3
36105	1952265	32	35	3,2	0,6
36106	1952266	40	42	3,7	0,7
36107	1952267	50	54	4,4	0,9
36108	1952268	65	76,1	7,5	2,2
36109	1952269	80	88,9	8,5	2,5
36110	1952271	100	108	10,3	2,8
arc / Vinkel: 30°					
36121	1952282	12	15	3,3	1,3
36123	1952283	20	22	3,7	1,6
36124	1952284	25	28	4,1	1,8
36125	1952285	32	35	3,7	1,1
36126	1952286	40	42	4,4	1,4
36127	1952287	50	54	5,2	1,7
36128	1952288	65	76,1	8,8	3,5
36129	1952289	80	88,9	10,1	4,1
36130	1952291	100	108	12,2	4,7
arc / Vinkel: 45°					
30601		10	12	2,3	0,6
30602	1950489	12	15	2,8	0,8
30603	1950493	15	18	2,9	0,9
30604	1950496	20	22	3,2	1,1
30605	1950499	25	28	3,7	1,4
32606	1950503	32	35	4,3	1,7
32607	1950506	40	42	5,1	2,1
32608	1950509	50	54	6,2	2,7
32609	1950523	65	76,1	10,3	5
32610	1950526	80	88,9	11,7	5,7
32611	1950529	100	108	14,3	6,8
arc / Vinkel: 60°					
36161	1952302	12	15	4	2
36163	1952303	20	22	4,7	2,6
36164	1952304	25	28	5,4	3,1
36165	1952305	32	35	5	2,4
36166	1952306	40	42	5,9	2,9
36167	1952307	50	54	7,2	3,7
36168	1952308	65	76,1	11,7	6,4
36169	1952309	80	88,9	13,6	7,6
36170	1952311	100	108	16,6	9,1
arc / Vinkel: 90°					
30101		10	12	4,2	2,5
30102	1950119	12	15	4,9	2,9
30103	1950123	15	18	5,3	3,3
30104	1950126	20	22	6,1	4
30105	1950129	25	28	5,7	3,4
31106	1950133	32	35	6,8	4,2
31107	1950136	40	42	8	5
31108	1950139	50	54	10	6,5
31109	1950153	65	76,1	15,9	10,6
31110	1950156	80	88,9	18,5	12,5
31111	1950159	100	108	23	15,5

Geberit Mapress Syrefast Stål bend med spissende

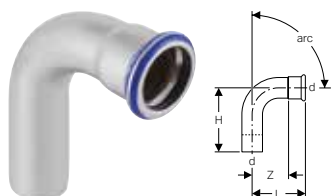

click & scan

Art. nr.	NRF nr.	DN	d, ø [mm]	L [cm]	H [cm]	Z [cm]
arc / Vinkel: 15°						
36111	1952272	12	15	3	4	1
36113	1952273	20	22	3,3	4,1	1,2
36114	1952274	25	28	3,6	4,3	1,3
36115	1952275	32	35	3,2	4,1	0,6
36116	1952276	40	42	3,7	4,7	0,7
36117	1952277	50	54	4,4	5,5	0,9
36118	1952278	65	76,1	7,5	8,4	2,2
36119	1952279	80	88,9	8,5	9,5	2,5
36120	1952281	100	108	10,3	11,7	2,8
arc / Vinkel: 30°						
36131	1952292	12	15	3,3	4,3	1,3
36133	1952293	20	22	3,7	4,6	1,6
36134	1952294	25	28	4,1	4,8	1,8
36135	1952295	32	35	3,7	4,6	1,1
36136	1952296	40	42	4,4	5,4	1,4
36137	1952297	50	54	5,2	6,3	1,7
36138	1952298	65	76,1	8,8	9,7	3,5
36139	1952299	80	88,9	10,1	11,1	4,1
36140	1952301	100	108	12,2	13,6	4,7
arc / Vinkel: 45°						
30701		10	12	2,3	3,1	0,6
30702	1950559	12	15	2,8	3,6	0,8
30703	1950563	15	18	2,9	3,6	0,9
30704	1950566	20	22	3,2	3,9	1,1
30705	1950569	25	28	3,7	4,4	1,4
32706	1950573	32	35	4,3	5	1,7
32707	1950576	40	42	5,1	5,9	2,1
32708	1950579	50	54	6,2	7	2,7
32709	1950593	65	76,1	10,3	11,1	5
32710	1950596	80	88,9	11,7	12,8	5,7
32711	1950599	100	108	14,3	15,8	6,8
arc / Vinkel: 60°						
36171	1952312	12	15	4	5	2
36173	1952313	20	22	4,7	5,6	2,6
36174	1952314	25	28	5,4	6,1	3,1
36175	1952315	32	35	5	5,9	2,4
36176	1952316	40	42	5,9	6,9	2,9
36177	1952317	50	54	7,2	8,3	3,7
36178	1952318	65	76,1	11,7	12,6	6,4
36179	1952319	80	88,9	13,6	14,6	7,6
36180	1952321	100	108	16,6	18	9,1
arc / Vinkel: 90°						
30301		10	12	4,2	4,8	2,5
30302	1950249	12	15	4,9	5,9	2,9
30303	1950252	15	18	5,3	6,1	3,3
30304	1950253	20	22	6,1	7	4
30305	1950256	25	28	5,7	6,3	3,4
33306	1950259	32	35	6,8	7,4	4,2
33307	1950263	40	42	8	8,8	5
33308	1950266	50	54	10	10,8	6,5
33309	1950283	65	76,1	15,9	16,7	10,6
33310	1950286	80	88,9	18,5	19,5	12,5
33311	1950289	100	108	23	24,1	15,5

Geberit Mapress Syrefast Stål passbend

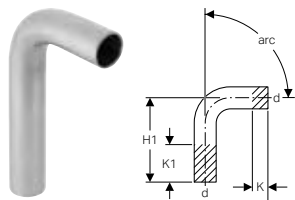

click & scan



Art. nr.	NRF nr.	DN	d, ø [mm]	H [cm]	H1 [cm]	K [cm]	K1 maks. [cm]
arc / Vinkel: 15°							
30892	1952368	12	15	4	11	0	7
30893	1952369	15	18	4	11,2	0	7,1
30894	1952371	20	22	4,1	11,4	0	7,3
30905	1951756	25	28	4,3	11,9	0	7,6
30906	1951758	32	35	4,1	11,8	0	7,7
30907	1951761	40	42	4,7	13,7	0	9
30908	1951763	50	54	5,5	14,9	0	9,4
30009	1952365	65	76,1	8,4	20,4	0	12
30010	1952366	80	88,9	9,5	22	0	12,5
30011	1952367	100	108	11,7	25,4	0	13,7
arc / Vinkel: 30°							
30932	1952375	12	15	4,3	11,3	0	7
30933	1952376	15	18	4,4	11,6	0	7,1
30934	1952377	20	22	4,6	11,8	0	7,2
30935	1951796	25	28	4,8	12,4	0	7,6
30936	1951798	32	35	4,6	12,3	0	7,7
30937	1951801	40	42	5,4	14,4	0	9
30938	1951803	50	54	6,3	15,7	0	9,4
30029	1952372	65	76,1	9,7	21,7	0	12
30030	1952373	80	88,9	11,1	23,6	0	12,5
30031	1952374	100	108	13,6	27,3	0	13,7
arc / Vinkel: 45°							
30872	1952382	12	15	4,5	11,6	0	7,1
30873	1952383	15	18	4,2	11,7	0	7,5
30874	1952384	20	22	5,2	12,3	0	7,1
30875	1952385	25	28	5,6	13,1	0	7,5
30876	1952386	32	35	5,3	12,9	0	7,6
30877	1952387	40	42	6,1	15,1	0	9
30878	1952388	50	54	7,3	16,7	0	9,4
30049	1952378	65	76,1	11,1	23	0	11,9
30050	1952379	80	88,9	13	25,2	0	12,2
30051	1952381	100	108	15,7	29,4	0	13,7
arc / Vinkel: 60°							
30942	1952389	12	15	5	12	0	7
30943	1952391	15	18	5,3	12,4	0	7,1
30944	1952392	20	22	5,6	12,8	0	7,2
30955	1951836	25	28	6,1	13,7	0	7,6
30956	1951838	32	35	5,9	13,6	0	7,7
30957	1951841	40	42	6,9	15,9	0	9
30958	1951843	50	54	8,3	17,7	0	9,4
30069		65	76,1	12,6	24,6	0	12
30070		80	88,9	14,6	27,1	0	12,5
30071		100	108	18	31,7	0	13,7
arc / Vinkel: 90°							
30402	1950449	12	15	5,9	12,9	0	7
30403	1950453	15	18	6,1	13,3	0	7,2
30404	1950456	20	22	7	14,2	0	7,2
30405	1950459	25	28	7,9	15,5	0	7,6
30406	1950463	32	35	7,7	15,4	0	7,7
30407	1950466	40	42	9	18	0	9
30408	1950469	50	54	11,1	20,5	0	9,4
30089	1952393	65	76,1	16,6	28,6	0	12
30090	1952394	80	88,9	19,4	31,9	0	12,5
30091	1952395	100	108	24	37,7	0	13,7

Geberit Mapress Syrefast Stål langt passbend 90°

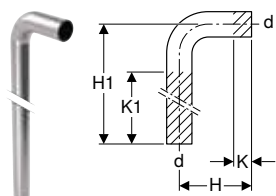

click & scan

Art. nr.	NRF nr.	DN	d, ø [mm]	arc [°]	H [cm]	H1 [cm]	K [cm]	K1 maks. [cm]
30414	1952326	20	22	90	7	84	1,5	70
30415	1952327	25	28	90	8	85	1,7	77

Geberit Mapress Syrefast Stål bypass-rør

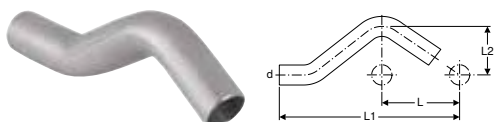

click & scan

Art. nr.	NRF nr.	DN	d, ø [mm]	L [cm]	L1 [cm]	L2 [cm]
30802	1951359	12	15	6	16,5	3,2
30803	1951363	15	18	6	16,6	3,3
30804	1951366	20	22	6	16,8	3,5
30805	1951369	25	28	6	17,9	3,8

T-rør

Geberit Mapress Syrefast Stål T-rør likt

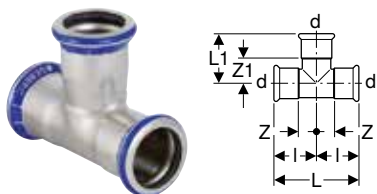

click & scan

Art. nr.	NRF nr.	DN	d, ø [mm]	arc [°]	L [cm]	L1 [cm]	I [cm]	Z [cm]	Z1 [cm]
33008		10	12	90	5,6	3,5	2,8	1,1	1,8
31002	1950989	12	15	90	6,4	3,9	3,2	1,2	1,9
31003	1950993	15	18	90	6,8	4,1	3,4	1,4	2,1
31004	1950996	20	22	90	7,4	4,4	3,7	1,6	2,3
31005	1950999	25	28	90	8,4	5	4,2	1,9	2,7
31006	1951003	32	35	90	10	5,7	5	2,4	3,1
31007	1951006	40	42	90	11,4	6,5	5,7	2,7	3,5
31008	1951009	50	54	90	13,8	7,7	6,9	3,4	4,2
31009	1951023	65	76,1	90	23	11	11,5	6,2	5,7
31010	1951026	80	88,9	90	26	12,7	13	7	6,7
31011	1951029	100	108	90	31	15,3	15,5	8	7,8

Geberit Mapress Syrefast Stål T-rør redusert

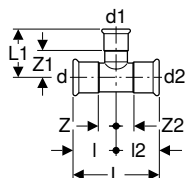

click & scan



Art. nr.	NRF nr.	DN	d, ø [mm]	d1, ø [mm]	d2, ø [mm]	arc [°]	L [cm]	L1 [cm]	I [cm]	I2 [cm]	Z [cm]	Z1 [cm]	Z2 [cm]
33005		12 / 10 / 12	15	12	15	90	6,4	3,5	3,2	3,2	1,2	1,8	1,2
31208	1952407	15 / 12 / 12	18	15	15	90	7,9	4,1	3,4	4,5	1,4	2,1	2,5
31204	1951056	15 / 12 / 15	18	15	18	90	6,8	4,1	3,4	3,4	1,4	2,1	1,4
31227	1952408	20 / 12 / 15	22	15	18	90	8,5	4,3	3,7	4,8	1,6	2,3	2,8
31206	1951059	20 / 12 / 20	22	15	22	90	7,4	4,3	3,7	3,7	1,6	2,3	1,6
31228	1952409	20 / 15 / 15	22	18	18	90	8,5	4,3	3,7	4,8	1,6	2,3	2,8
31207	1951062	20 / 15 / 20	22	18	22	90	7,4	4,3	3,7	3,7	1,6	2,3	1,6
31209	1951063	25 / 12 / 25	28	15	28	90	8,4	4,6	4,2	4,2	1,9	2,6	1,9
31210	1951065	25 / 15 / 25	28	18	28	90	8,4	4,6	4,2	4,2	1,9	2,6	1,9
31234	1952411	25 / 20 / 20	28	22	22	90	9	4,7	4,2	4,8	1,9	2,6	2,7
31211	1951066	25 / 20 / 25	28	22	28	90	8,4	4,7	4,2	4,2	1,9	2,6	1,9
31212	1951069	32 / 12 / 32	35	15	35	90	10	4,9	5	5	2,4	2,9	2,4
31213	1951071	32 / 15 / 32	35	18	35	90	10	4,9	5	5	2,4	2,9	2,4
31235	1952412	32 / 20 / 25	35	22	28	90	10,4	5	5	5,4	2,4	2,9	3,1
31214	1951073	32 / 20 / 32	35	22	35	90	10	5	5	5	2,4	2,9	2,4
31242	1952413	32 / 25 / 25	35	28	28	90	10,4	5,3	5	5,4	2,4	3	3,1
31215	1951076	32 / 25 / 32	35	28	35	90	10	5,3	5	5	2,4	3	2,4
31216	1951077	40 / 12 / 40	42	15	42	90	11,4	5,3	5,7	5,7	2,7	3,3	2,7
31217	1951078	40 / 15 / 40	42	18	42	90	11,4	5,3	5,7	5,7	2,7	3,3	2,7
31243	1952414	40 / 20 / 32	42	22	35	90	11,5	5,4	5,7	5,8	2,7	3,3	3,2
31218	1951079	40 / 20 / 40	42	22	42	90	11,4	5,4	5,7	5,7	2,7	3,3	2,7
31251	1952415	40 / 25 / 32	42	28	35	90	11,5	5,7	5,7	5,8	2,7	3,4	3,2
31219	1951083	40 / 25 / 40	42	28	42	90	11,4	5,7	5,7	5,7	2,7	3,4	2,7
31220	1951086	40 / 32 / 40	42	35	42	90	11,4	6,1	5,7	5,7	2,7	3,5	2,7
31221	1951087	50 / 12 / 50	54	15	54	90	13,8	5,9	6,9	6,9	3,4	3,9	3,4
31222	1951088	50 / 15 / 50	54	18	54	90	13,8	5,9	6,9	6,9	3,4	3,9	3,4
31223	1951089	50 / 20 / 50	54	22	54	90	13,8	6	6,9	6,9	3,4	3,9	3,4
31224	1951093	50 / 25 / 50	54	28	54	90	13,8	6,3	6,9	6,9	3,4	4	3,4
31225	1951096	50 / 32 / 50	54	35	54	90	13,8	6,7	6,9	6,9	3,4	4,1	3,4
31226	1951099	50 / 40 / 50	54	42	54	90	13,8	7,1	6,9	6,9	3,4	4,1	3,4
31229	1951117	65 / 20 / 65	76,1	22	76,1	90	23	7,2	11,5	11,5	6,2	5,1	6,2
31230	1951118	65 / 25 / 65	76,1	28	76,1	90	23	7,5	11,5	11,5	6,2	5,2	6,2
31231	1951119	65 / 32 / 65	76,1	35	76,1	90	23	7,9	11,5	11,5	6,2	5,3	6,2
31232	1951121	65 / 40 / 65	76,1	42	76,1	90	23	8,3	11,5	11,5	6,2	5,3	6,2
31233	1951123	65 / 50 / 65	76,1	54	76,1	90	23	8,9	11,5	11,5	6,2	5,4	6,2
31236	1951122	80 / 20 / 80	88,9	22	88,9	90	26	7,8	13	13	7	5,7	7
31237	1951124	80 / 25 / 80	88,9	28	88,9	90	26	8,1	13	13	7	5,8	7
31238	1951125	80 / 32 / 80	88,9	35	88,9	90	26	8,5	13	13	7	5,9	7
31239	1951127	80 / 40 / 80	88,9	42	88,9	90	26	8,9	13	13	7	5,9	7
31240	1951128	80 / 50 / 80	88,9	54	88,9	90	26	9,5	13	13	7	6	7
31241	1951126	80 / 65 / 80	88,9	76,1	88,9	90	26	11,6	13	13	7	6,3	7
31244	1951131	100 / 20 / 100	108	22	108	90	31	8,8	15,5	15,5	8	6,7	8
31245	1951132	100 / 25 / 100	108	28	108	90	31	9,1	15,5	15,5	8	6,8	8
31246	1951133	100 / 32 / 100	108	35	108	90	31	9,5	15,5	15,5	8	6,9	8
31247	1951134	100 / 40 / 100	108	42	108	90	31	9,9	15,5	15,5	8	6,9	8
31248	1951135	100 / 50 / 100	108	54	108	90	31	10,5	15,5	15,5	8	7	8
31249	1951136	100 / 65 / 100	108	76,1	108	90	31	12,6	15,5	15,5	8	7,3	8
31250	1951129	100 / 80 / 100	108	88,9	108	90	31	13,7	15,5	15,5	8	7,7	8

Geberit Mapress Syrefast Stål T-rør med utvendige gjenger

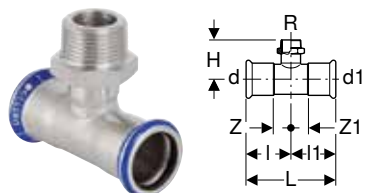

click & scan

Art. nr.	NRF nr.	DN	d, ø [mm]	R ["]	d1, ø [mm]	arc [°]	L [cm]	l [cm]	l1 [cm]	H [cm]	Z [cm]	Z1 [cm]
31401	1952416	12 / 10 / 12	15	3/8"	15	90	6,4	3,2	3,2	5	1,2	1,2
31454	1952417	12 / 15 / 12	15	1/2"	15	90	6,4	3,2	3,2	4	1,2	1,2
31455	1952418	15	18	1/2"	18	90	6,8	3,4	3,4	4,2	1,4	1,4
31458	1952419	20	22	3/4"	22	90	7,4	3,7	3,7	4,8	1,6	1,6
31461	1952421	25	28	1"	28	90	8,4	4,2	4,2	5,4	1,9	1,9
31464	1952422	32	35	1 1/4"	35	90	10	5	5	6	2,4	2,4

Geberit Mapress Syrefast Stål T-rør med innvendige gjenger

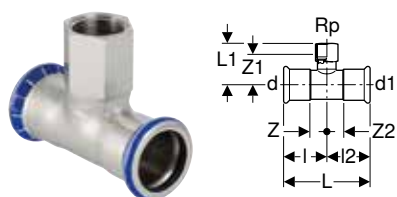

click & scan

Art. nr.	NRF nr.	DN	d, ø [mm]	Rp ["]	d1, ø [mm]	arc [°]	L [cm]	L1 [cm]	l [cm]	l2 [cm]	Z [cm]	Z1 [cm]	Z2 [cm]
31303		10 / 12 / 10	12	3/8"	12	90	5,6	3,2	2,8	2,8	1	2,1	1
31304	1951159	12 / 15 / 12	15	1/2"	15	90	6,4	4	3,2	3,2	1,2	2,7	1,2
31305	1951163	15	18	1/2"	18	90	6,8	4,1	3,4	3,4	1,4	2,9	1,4
31306	1951164	15 / 20 / 15	18	3/4"	18	90	6,8	4,4	3,4	3,4	1,4	2,9	1,4
31307	1951166	20 / 15 / 20	22	1/2"	22	90	7,4	4,3	3,7	3,7	1,6	3	1,6
31308	1951169	20	22	3/4"	22	90	7,4	4,6	3,7	3,7	1,6	3,1	1,6
31309	1951173	25 / 15 / 25	28	1/2"	28	90	8,4	4,6	4,2	4,2	1,9	3,3	1,9
31310	1951176	25 / 20 / 25	28	3/4"	28	90	8,4	4,9	4,2	4,2	1,9	3,4	1,9
31311		25	28	1"	28	90	8,4	5,3	4,2	4,2	1,9	3,6	1,9
31312	1951179	32 / 15 / 32	35	1/2"	35	90	10	5	5	5	2,4	3,7	2,4
31313	1951183	32 / 20 / 32	35	3/4"	35	90	10	5,3	5	5	2,4	3,8	2,4
31314		32 / 25 / 32	35	1"	35	90	10	5,6	5	5	2,4	3,9	2,4
31316	1951186	40 / 15 / 40	42	1/2"	42	90	11,4	5,3	5,7	5,7	2,7	4	2,7
31317	1951189	40 / 20 / 40	42	3/4"	42	90	11,4	5,6	5,7	5,7	2,7	4,1	2,7
31318		40 / 25 / 40	42	1"	42	90	11,4	6	5,7	5,7	2,7	4,3	2,7
31320	1951193	50 / 15 / 50	54	1/2"	54	90	13,8	5,9	6,9	6,9	3,4	4,6	3,4
31321	1951196	50 / 20 / 50	54	3/4"	54	90	13,8	6,2	6,9	6,9	3,4	4,7	3,4
31322		50 / 25 / 50	54	1"	54	90	13,8	6,6	6,9	6,9	3,4	4,9	3,4
31324	1951209	50	54	2"	54	90	13,8	7,9	6,9	6,9	3,4	5,6	3,4
31326	1951223	65 / 20 / 65	76,1	3/4"	76,1	90	23	7,4	11,5	11,5	6,2	5,9	6,2
31329	1951225	65 / 50 / 65	76,1	2"	76,1	90	23	9,1	11,5	11,5	6,2	6,8	6,2
31331	1951226	80 / 20 / 80	88,9	3/4"	88,9	90	26	8	13	13	7	6,5	7
31334	1951228	80 / 50 / 80	88,9	2"	88,9	90	26	9,7	13	13	7	7,4	7
31336	1951229	100 / 20 / 100	108	3/4"	108	90	31	9	15,5	15,5	8	7,5	8
31339	1951235	100 / 50 / 100	108	2"	108	90	31	10,7	15,5	15,5	8	8,4	8

Innvendig sirkulasjon

Geberit Mapress koplingssett for rør i rør til varmtvannssirkulasjon

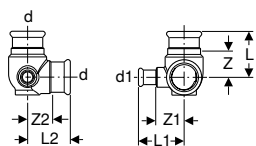

click & scan

Art. nr.	NRF nr.	DN	d, ø [mm]	d1, ø [mm]	arc [°]	L [cm]	L1 [cm]	L2 [cm]	Z [cm]	Z1 [cm]	Z2 [cm]
61275	1951031	25 / 12 / 25	28	15	90	5,8	5,7	5,4	3,5	3,7	3,1
61276	1951032	32 / 12 / 32	35	15	90	5,8	5,7	5,4	3,2	3,7	2,8

Geberit rør for rør i rør til varmtvannssirkulasjon

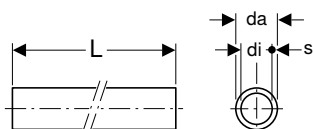

click & scan

Art. nr.	NRF nr.	da [mm]	di, ø [mm]	s [mm]	L [m]
600.101.00.2	1951034	14	11	1,5	50

Geberit kopling for rør for rør i rør til varmtvannssirkulasjon

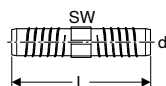

click & scan

Art. nr.	d, ø [mm]	L [cm]	SW [mm]
242.737.00.1	14	5,6	12

Overganger uløselige

Geberit Mapress Syrefast Stål overgangsstykke med sveisbar ende og spissende

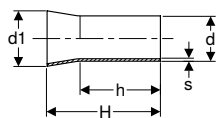

click & scan

Art. nr.	NRF nr.	DN	d, ø [mm]	d1, ø [mm]	s [mm]	H [cm]	h [cm]
32412	1950042	12	15	17,2	1	4,5	3,4
32413	1950043	15	18	21,3	1	5	3,7
32414	1950044	20	22	26,9	1,2	5,5	3,9
32415	1950045	25	28	33,7	1,2	5,5	3,9
32416	1950046	32	35	42,4	1,5	6,5	4,4
32417	1950047	40	42	48,3	1,5	7,5	5,4
32418	1950048	50	54	60,3	1,5	8	5,8
32419	1950049	65	76,1	76,1	2	12	
32420	1950051	80	88,9	88,9	2	13,5	
32421	1950052	100	108	114,3	2	15	12,8

Geberit FlowFit overgangsstykke til Geberit Mapress, med spissende, syrefast

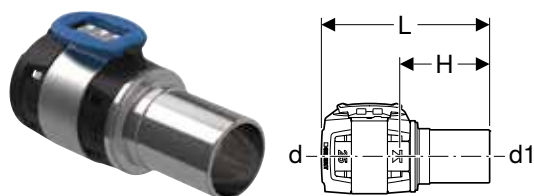

click & scan

Art. nr.	NRF nr.	DN	d, ø [mm]	d1, ø [mm]	L [cm]	H [cm]
620.250.00.1	2473616	12	16	15	7,1	3,8
620.252.00.1	2473618	15 / 20	20	22	7,2	3,9
620.253.00.1	2473619	20	25	22	7,2	3,9
620.254.00.1	2473621	25	32	28	7,9	4,3
620.255.00.1	2473622	32	40	35	8,2	4,6
620.256.00.1	2473623	40	50	42	12,5	6,6
620.257.00.1	2473624	50	63	54	14,2	7,9

Geberit FlowFit overgangsstykke til Geberit Mapress, med spissende

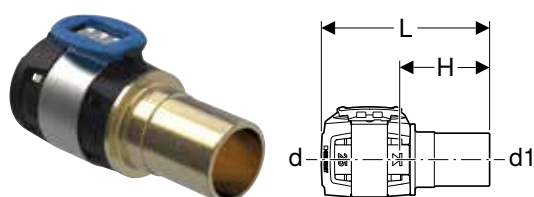

click & scan

Art. nr.	NRF nr.	DN	d, ø [mm]	d1, ø [mm]	L [cm]	H [cm]
620.230.00.1	2473605	12 / 10	16	12	6,8	3,5
620.240.00.1	2473606	12	16	15	6,9	3,6
620.231.00.1	2473607	15 / 12	20	15	6,9	3,6
620.241.00.1	2473615	15	20	18	6,9	3,6
620.242.00.1	2473608	15 / 20	20	22	7	3,7
620.232.00.1	2473609	20	25	22	7	3,7
620.233.00.1	2473611	25	32	28	7,7	4,1
620.234.00.1	2473612	32	40	35	8	4,4
620.235.00.1	2473613	40	50	42	12,8	6,9
620.236.00.1	2473614	50	63	54	13,8	7,5

Geberit FlowFit overgangsstykke til Geberit Mapress, med sammenføyning, syrefast

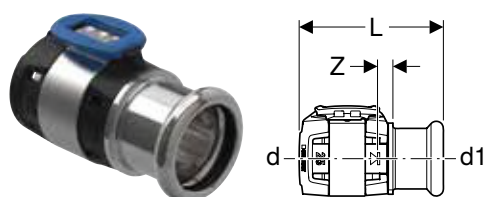

click & scan

Art. nr.	NRF nr.	DN	d, ø [mm]	d1, ø [mm]	L [cm]	Z [cm]
620.329.00.1	2472046	12 / 10	16	12	5,4	0,6
620.332.00.1	2472047	12	16	15	5,6	0,6
620.347.00.1	2472058	15 / 12	20	15	5,6	0,6
620.333.00.1	2472048	15	20	18	5,6	0,6
620.334.00.1	2472049	15 / 20	20	22	5,7	0,6
620.335.00.1	2472051	20	25	22	5,7	0,6
620.336.00.1	2472052	25	32	28	6,4	0,8
620.337.00.1	2472053	32	40	35	6,7	0,8
620.338.00.1	2472054	40	50	42	9,7	1,1
620.339.00.1	2472055	50	63	54	10,7	1,2

Geberit Mepla overgangsstykke til Geberit Mapress, med spissende

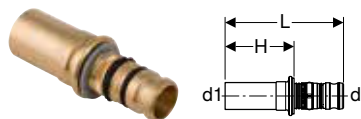

click & scan

Art. nr.	NRF nr.	DN	d, ø [mm]	d1, ø [mm]	L [cm]	H [cm]
601.507.00.5	2472922	12 / 10	16	12	5,8	3,3
601.508.00.5	2472241	12	16	15	5,9	3,4
602.507.00.5	2472248	15 / 12	20	15	6,1	3,4
602.508.00.5	2472242	15	20	18	6,1	3,4
602.509.00.5	2472923	15 / 20	20	22	6,2	3,5
603.508.00.5	2472243	20	26	22	6,7	3,5
604.508.00.5	2472244	25	32	28	6,6	3,7
605.508.00.5	2472245	32	40	35	7,5	4,1
606.508.00.5	2472246	40	50	42	10,1	6,3
607.508.00.5	2472247	50	63	54	13,6	7

Geberit Mapress Syrefast Stål overgangsstykke med utvendige gjenger



click & scan

Art. nr.	NRF nr.	DN	d, ø [mm]	R ["]	L [cm]	H [cm]
33017		10	12	3/8"	3,2	1,8
33009		10 / 15	12	1/2"	3,6	1,9
31726	1952331	12 / 10	15	3/8"	3,8	1,8
31703	1950759	12 / 15	15	1/2"	4,1	2,1
31714		12 / 20	15	3/4"	4,3	2,3
31704	1950763	15	18	1/2"	4,2	2,2
31705	1950764	15 / 20	18	3/4"	4,4	2,4
31715	1950765	20 / 15	22	1/2"	4,2	2,1
31707	1950766	20	22	3/4"	4,4	2,3
31716	1950767	20 / 25	22	1"	4,6	2,5
31717	1950768	25 / 20	28	3/4"	4,6	2,3
31708	1950769	25	28	1"	4,8	2,3
31718	1952328	25 / 32	28	1 1/4"	4,8	2,5
31719	1950772	32 / 25	35	1"	5,1	2,5
31709	1950773	32	35	1 1/4"	5,3	2,7
31720	1952329	32 / 40	35	1 1/2"	5,3	2,7
31721	1950774	40 / 32	42	1 1/4"	5,7	2,7
31710	1950776	40	42	1 1/2"	5,7	2,7
31722	1950778	50 / 40	54	1 1/2"	8,3	4,8
31711	1950779	50	54	2"	8,9	5,4
31713	1950783	65	76,1	2 1/2"	11,9	7
31724	1950786	80	88,9	3"	13,7	7,7

Geberit Mapress Syrefast Stål unionsdel med utvendige gjenger G

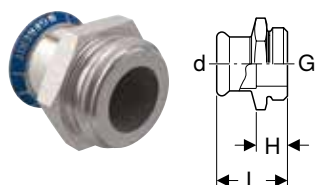

click & scan

Art. nr.	NRF nr.	DN	d, ø [mm]	G ["]	L [cm]	H [cm]
31731	1952477	12	15	3/4"	3,5	1,5
31732	1952478	15	18	3/4"	3,8	1,7
31733	1952479	20	22	1"	4	1,9
31734	1952481	25	28	1 1/4"	4,1	1,8
31735	1952482	32	35	1 1/2"	4,7	2,1
31736	1952483	40	42	1 3/4"	5,2	2,2
31737	1952484	50	54	2 3/8"	6,3	2,8

Geberit Mapress Syrefast Stål overgangsstykke med utvendige gjenger NPT

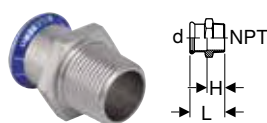

click & scan

Art. nr.	NRF nr.	DN	d, ø [mm]	NPT	L [cm]	H [cm]
31833	5017905	12 / 15	15	1/2"	4,8	2,8
31837	5017906	20	22	3/4"	4,9	2,8
31838	5017907	25	28	1"	5,6	3,1
31839	5017908	32	35	1 1/4"	6	3,4
31840	5017909	40	42	1 1/2"	6,5	3,5
31841	5017911	50	54	2"	7	3,5

Geberit Mapress Syrefast Stål overgangsstykke med utvendige gjenger og spissende

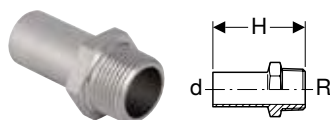

click & scan

Art. nr.	NRF nr.	DN	d, ø [mm]	R ["]	H [cm]
31932	1952336	12 / 15	15	1/2"	5,7
31933	1951963	15	18	1/2"	5,7
31936	1951965	20	22	3/4"	5,9
31937	1951967	25	28	1"	6,6
31938	1951969	32	35	1 1/4"	8
31939	1951972	40	42	1 1/2"	9,1
31940	1951974	50	54	2"	10,2

Geberit Mapress Syrefast Stål overgangsstykke med innvendige gjenger

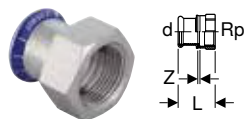

click & scan

Art. nr.	NRF nr.	DN	d, ø [mm]	Rp ["]	L [cm]	Z [cm]
33018		10	12	3/8"	3,2	0,2
33010		10 / 15	12	1/2"	3,4	0,4
31801	1952332	12 / 10	15	3/8"	3,5	0,5
31802	1950809	12 / 15	15	1/2"	3,7	0,4
31823	1950811	12 / 20	15	3/4"	3,8	0,3
31803	1950812	15	18	1/2"	3,7	0,4
31804	1950813	15 / 20	18	3/4"	3,8	0,3
31805	1950814	20 / 15	22	1/2"	3,6	0,2
31806	1950816	20	22	3/4"	3,9	0,3
31824	1950815	20 / 25	22	1"	4,2	0,4
31807	1950817	25 / 15	28	1/2"	3,8	0,2
31819	1950818	25 / 20	28	3/4"	3,9	0,3
31809	1950819	25	28	1"	4,4	0,4
31825	1952334	25 / 32	28	1 1/4"	4,6	0,4
31820	1950822	32 / 25	35	1"	4,5	0,2
31811	1950823	32	35	1 1/4"	4,9	0,4
31826	1952335	32 / 40	35	1 1/2"	4,9	0,4
31821		40 / 32	42	1 1/4"	5,1	0,2
31814	1950826	40	42	1 1/2"	5,3	0,4
31822	1952333	50 / 40	54	1 1/2"	7,7	2,1
31818	1950829	50	54	2"	6,2	0,4

Geberit Mapress Syrefast Stål overgangsstykke med innvendige gjenger og spissende

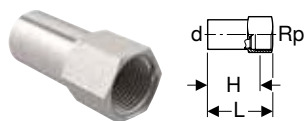

click & scan

Art. nr.	NRF nr.	DN	d, ø [mm]	Rp ["]	L [cm]	H [cm]
33846	1952337	20 / 15	22	1/2"	5,8	4,5
33848	1952338	25 / 15	28	1/2"	6,6	5,3
33850	1952339	32 / 15	35	1/2"	6,9	5,6
33852	1952341	40 / 15	42	1/2"	7,4	6,1
33854	1952342	50 / 15	54	1/2"	7,9	6,6
33860	1952343	65 / 15	76,1	1/2"	10,4	9,1
33862	1952344	80 / 15	88,9	1/2"	11,3	10
33864	1952345	100 / 15	108	1/2"	13,4	12,1

Geberit Mapress Syrefast Stål overgangsstykke med innvendige gjenger og spissende langt

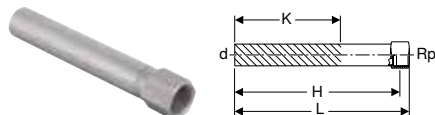

click & scan

Art. nr.	NRF nr.	DN	d, ø [mm]	Rp ["]	L [cm]	H [cm]	K [cm]
90932	1952359	12 / 15	15	1/2"	14,8	13,5	9
90933	1952361	15	18	1/2"	14,8	13,5	9
90934	1952362	15 / 20	18	3/4"	15,2	13,3	9
90935	1952363	20 / 15	22	1/2"	14,8	13,9	8,9
90936	1952364	20	22	3/4"	15,2	13,7	8,7

Geberit Mapress Syrefast Stål albue 90° med utvendige gjenger

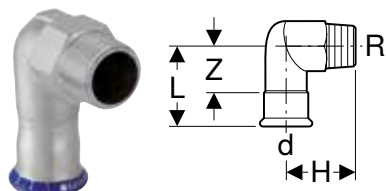

click & scan

Art. nr.	NRF nr.	DN	d, ø [mm]	R ["]	arc [°]	L [cm]	H [cm]	Z [cm]
33833	1950309	12 / 15	15	1/2"	90	5,7	3,7	3,7
33834	1950313	15	18	1/2"	90	5,7	3,9	3,7
33835	1950316	20	22	3/4"	90	6	4,6	3,9
33836	1950319	25	28	1"	90	6,7	5,4	4,4
33837	1950323	32	35	1 1/4"	90	7,5	6,3	4,9
33838	1950326	40	42	1 1/2"	90	8,3	6,7	5,3
33839	1950329	50	54	2"	90	9,4	7,8	5,9

Geberit Mapress Syrefast Stål albue 90° med innvendige gjenger

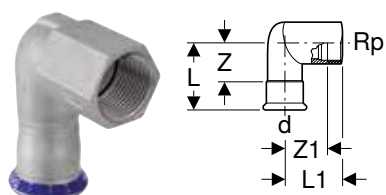

click & scan

Art. nr.	NRF nr.	DN	d, ø [mm]	Rp ["]	arc [°]	L [cm]	L1 [cm]	Z [cm]	Z1 [cm]
33802	1952261	12 / 10	15	3/8"	90	5,7	3,4	3,7	2,4
33803	1950363	12 / 15	15	1/2"	90	5,7	3,7	3,7	2,4
33804	1950364	15	18	1/2"	90	5,7	3,9	3,7	2,6
33805	1950366	20	22	3/4"	90	6	4,6	3,9	3,1
33806	1950369	25	28	1"	90	6,7	5,4	4,3	3,7
33807	1950373	32	35	1 1/4"	90	7,5	6,3	4,9	4,4

Geberit Mapress Syrefast Stål albue 90° med innvendige gjenger og spissende

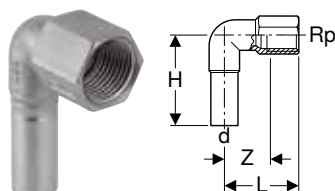

click & scan

Art. nr.	NRF nr.	DN	d, ø [mm]	Rp ["]	arc [°]	L [cm]	H [cm]	Z [cm]
33203	1950359	12 / 15	15	1/2"	90	3,6	5,3	2,3

Overganger og forbindelser, løsbare

Geberit Mapress Syrefast Stål union



click & scan

Art. nr.	NRF nr.	DN	d, ø [mm]	G ["]	L [cm]	Z [cm]
35320	1952434	12	15	3/4"	6,6	2,6
35321	1952435	15	18	3/4"	6,9	2,9
35322	1952436	20	22	1"	7,2	3
35323	1952437	25	28	1 1/4"	7,7	3,1
35324	1952438	32	35	1 1/2"	8,2	3
35325	1952439	40	42	1 3/4"	9,5	3,5
35326	1952441	50	54	2 3/8"	11,3	4,3

Geberit Mapress Syrefast Stål union med unionmutter av CrNi-stål



click & scan

Art. nr.	NRF nr.	DN	d, ø [mm]	G ["]	L [cm]	Z [cm]
35390	1952462	12	15	3/4"	6,6	2,6
35391	1952463	15	18	3/4"	6,9	2,9
35392	1952464	20	22	1"	7,2	3
35393	1952465	25	28	1 1/4"	7,7	3,1
35394	1952466	32	35	1 1/2"	8,2	3
35395	1952467	40	42	1 3/4"	9,5	3,5
35396	1952468	50	54	2 3/8"	11,3	4,3

Geberit Mapress Syrefast Stål overgangsstykke med unionmutter

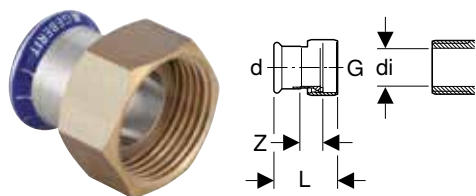

click & scan

Art. nr.	NRF nr.	DN	d, ø [mm]	G ["]	di, ø [mm]	L [cm]	Z [cm]
35042	1952348	12	15	1/2"	10	5,1	2,5
35032	1950832	12 / 20	15	3/4"	13	3,7	1,1
35072	1952354	12	15	1 1/4"	26	4,3	1,3
35033	1950834	15 / 20	18	3/4"	13	3,7	1,1
35034	1950836	20 / 25	22	1"	20	4	1,1
35044	1952349	20	22	1 1/4"	26	4,3	1,3
35045	1952351	20	22	1 1/2"	32	4,4	1,3
35046	1952352	25	28	1"	20	5,5	2,4
35035	1950838	25 / 32	28	1 1/4"	26	4,4	1,3
35047	1952353	25 / 40	28	1 1/2"	32	4,6	1,3
35036	1950841	32 / 40	35	1 1/2"	32	4,8	1,3
35037	1950843	40	42	1 3/4"	39	5,2	1,3
35038	1950845	50 / 60	54	2 3/8"	51	5,8	1,5
35039	1952346	65 / 80	76,1	3"	73	9,9	3,3
35040	1952347	80 / 90	88,9	3 1/2"	84	11,1	3,7

Geberit Mapress Syrefast Stål overgangsstykke med unionmutter av CrNi-stål

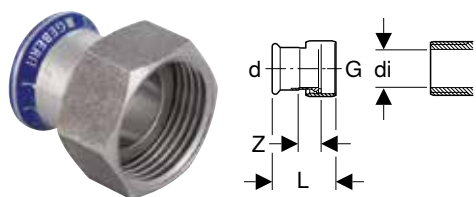

click & scan

Art. nr.	NRF nr.	DN	d, ø [mm]	G ["]	di, ø [mm]	L [cm]	Z [cm]
35132	1952356	12	15	3/4"	13	3,7	1,1
35133	1952357	15	18	3/4"	13	3,7	1,2
35134	1952358	20	22	1"	20	4	1,1
35075	1952355	25	28	1 1/2"	32	4,4	1,3

Geberit Mapress Syrefast Stål union med utvendige gjenger



click & scan

Art. nr.	NRF nr.	DN	d, ø [mm]	R ["]	G ["]	L [cm]	H [cm]
35330	1952442	12 / 15	15	1/2"	3/4"	6,4	4,4
35331	1952443	12 / 20	15	3/4"	3/4"	6,6	4,6
35332	1952444	15	18	1/2"	3/4"	6,4	4,4
35333	1952445	15 / 20	18	3/4"	3/4"	6,6	4,6
35334	1952446	20 / 15	22	1/2"	1"	6,7	4,6
35335	1952447	20	22	3/4"	1"	6,8	4,7
35336	1952448	20 / 25	22	1"	1"	7,3	5,2
35337	1952449	25	28	1"	1 1/4"	7,8	5,5
35338	1952451	32	35	1 1/4"	1 1/2"	8,5	5,9
35339	1952452	40	42	1 1/2"	1 3/4"	9	6
35340	1952453	50	54	2"	2 3/8"	10,3	6,8

Geberit Mapress Syrefast Stål union med utvendige gjenger, unionmutter av CrNi-stål



click & scan

Art. nr.	NRF nr.	DN	d, ø [mm]	R ["]	G ["]	L [cm]	H [cm]
35360	1951309	12 / 15	15	1/2"	3/4"	6,4	4,4
35361	1951311	12 / 20	15	3/4"	3/4"	6,6	4,6
35362	1951313	15	18	1/2"	3/4"	6,4	4,4
35363	1951314	15 / 20	18	3/4"	3/4"	6,6	4,6
35364	1951315	20 / 15	22	1/2"	1"	6,7	4,6
35365	1951316	20	22	3/4"	1"	6,8	4,7
35366	1951317	20 / 25	22	1"	1"	7,3	5,2
35367	1951319	25	28	1"	1 1/4"	7,8	5,5
35368	1951323	32	35	1 1/4"	1 1/2"	8,5	5,9
35369	1951326	40	42	1 1/2"	1 3/4"	9	6
35370	1951329	50	54	2"	2 3/8"	10,3	6,8

Geberit Mapress Syrefast Stål union med utvendige gjenger og spissende

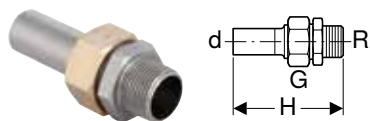

click & scan

Art. nr.	NRF nr.	DN	d, ø [mm]	R ["]	G ["]	H [cm]
35400	1952469	12 / 15	15	1/2"	3/4"	8,6
35402	1952471	15	18	1/2"	3/4"	8,6
35405	1952472	20	22	3/4"	1"	9,2
35407	1952473	25	28	1"	1 1/4"	10,1
35408	1952474	32	35	1 1/4"	1 1/2"	10,9
35409	1952475	40	42	1 1/2"	1 3/4"	11,5
35410	1952476	50	54	2"	2 3/8"	12,9

Geberit Mapress Syrefast Stål union med innvendige gjenger



click & scan

Art. nr.	NRF nr.	DN	d, ø [mm]	Rp ["]	G ["]	L [cm]	Z [cm]
35300	1952423	12 / 15	15	1/2"	3/4"	5,9	2,6
35301	1952424	12 / 20	15	3/4"	3/4"	6,1	2,6
35302	1952425	15	18	1/2"	3/4"	5,9	2,6
35303	1952426	15 / 20	18	3/4"	3/4"	6,1	2,6
35304	1952427	20	22	3/4"	1"	6,3	2,7
35305	1952428	20 / 25	22	1"	1"	6,6	2,8
35306	1952429	25	28	1"	1 1/4"	7,1	3,1
35307	1952431	32	35	1 1/4"	1 1/2"	7,7	3,2
35308	1952432	40	42	1 1/2"	1 3/4"	8,2	3,3
35309	1952433	50	54	2"	2 3/8"	9,5	3,7

Geberit Mapress Syrefast Stål union med innvendige gjenger, unionmutter av CrNi-stål



click & scan

Art. nr.	NRF nr.	DN	d, ø [mm]	Rp ["]	G ["]	L [cm]	Z [cm]
35350	1951722	12 / 15	15	1/2"	3/4"	5,9	2,6
35357	1951724	12 / 20	15	3/4"	3/4"	6,1	2,6
35351	1951726	15	18	1/2"	3/4"	5,9	2,6
35358	1951728	15 / 20	18	3/4"	3/4"	6,1	2,6
35352	1951731	20	22	3/4"	1"	6,3	2,7
35359	1951733	20 / 25	22	1"	1"	6,6	2,8
35353	1951735	25	28	1"	1 1/4"	7,1	3,1
35354	1951737	32	35	1 1/4"	1 1/2"	7,7	3,2
35355	1951739	40	42	1 1/2"	1 3/4"	8,2	3,3
35356	1951742	50	54	2"	2 3/8"	9,5	3,7

Geberit Mapress Syrefast Stål union med innvendige gjenger og spissende



click & scan

Art. nr.	NRF nr.	DN	d, ø [mm]	Rp ["]	G ["]	L [cm]	H [cm]
35380	1952454	12 / 15	15	1/2"	3/4"	8,1	5,9
35382	1952455	15	18	1/2"	3/4"	8,1	5,9
35384	1952456	20	22	3/4"	1"	8,7	6,4
35386	1952457	25	28	1"	1 1/4"	9,4	6,7
35387	1952458	32	35	1 1/4"	1 1/2"	10,1	7,2
35388	1952459	40	42	1 1/2"	1 3/4"	10,7	7,7
35389	1952461	50	54	2"	2 3/8"	12	8,4

Geberit Mapress-overgang med kompresjonsringmontering for bølgerør, NPW, innsettsende

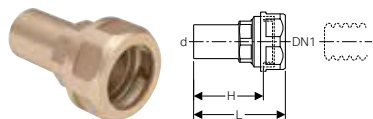

click & scan

Art. nr.	DN	DN1	d, ø [mm]	L [cm]	H [cm]	PN [bar]
22421	12	16	15	6,4	4,9	10
22431	12	20	15	6,7	5,2	10
22422	15	16	18	6,4	4,9	10
22432	15	20	18	6,7	5,2	10
22423	20	16	22	6,8	5,9	10
22433	20	20	22	6,8	5,9	10
22444	25	25	28	6,8	5,9	10



- Hvis skrukoplingen og bølgerøret har ulikt driftstrykk, er det laveste driftstrykket retningsgivende

Geberit Mapress Syrefast Stål flens PN 10/16, med muffe

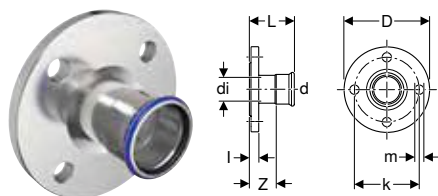

click & scan

Art. nr.	NRF nr.	DN	d, ø [mm]	di, ø [mm]	D [cm]	k [mm]	m [mm]	L [cm]	I [cm]	Z [cm]	n [pc.]	PN [bar]
33732	1950174	15 / 12	15	15	9,5	65	14	6,1	1,6	4,1	4	10 / 16
33733	1950175	15	18	15	9,5	65	14	6,2	1,6	4,2	4	10 / 16
33734	1950176	20	22	19	10,5	75	14	6,5	1,8	4,4	4	10 / 16
33735	1950177	25	28	25	11,5	85	14	6,9	1,8	4,6	4	10 / 16
33736	1950178	32	35	32	14	100	18	7,2	1,8	4,6	4	10 / 16
33737	1950179	40	42	39	15	110	18	7,9	1,8	4,9	4	10 / 16
33738	1950181	50	54	51	16,5	125	18	8,7	1,8	5,2	4	10 / 16
33739	1950182	65	76,1	72	18,5	145	18	11,8	1,8	6,5	4	10 / 16
33740	1950161	80	88,9	84,8	20	160	18	12,5	2	6,5	8	10 / 16
33741	1950162	100	108	103,9	22	180	18	13	2	5,5	8	10 / 16

Geberit Mapress Syrefast Stål flens PN 10/16, med spissende

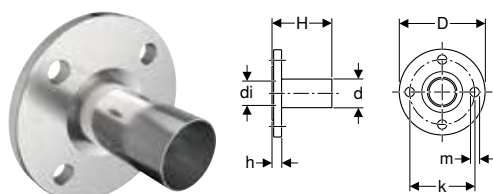

click & scan

Art. nr.	NRF nr.	DN	d, ø [mm]	di, ø [mm]	D [cm]	k [mm]	m [mm]	H [cm]	h [cm]	n [pc.]	PN [bar]
33744	1950088	20	22	19	10,5	75	14	7,9	1,8	4	10 / 16
33745	1950089	25	28	25	11,5	85	14	8,1	1,8	4	10 / 16
33746	1950091	32	35	32	14	100	18	9	1,8	4	10 / 16
33747	1950092	40	42	39	15	110	18	10,8	1,8	4	10 / 16
33748	1952322	50	54	51	16,5	125	18	11,3	1,8	4	10 / 16
33749	1952323	65	76,1	72	18,5	145	18	13,6	1,8	4	10 / 16
33750	1952324	80	88,9	84,8	20	160	18	15,2	2	8	10 / 16
33752	1952325	100	108	103,9	22	180	18	16,5	2	8	10 / 16

Geberit Mapress Syrefast Stål spissende for løsfleis PN 10/16

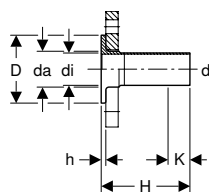

click & scan



Art. nr.	NRF nr.	DN	d, ø [mm]	da [mm]	di, ø [mm]	D [cm]	H [cm]	h [cm]	K [cm]	PN [bar]
36141	1952398	20	22	27	19,6	5,8	13,5	0,6	3,5	10 / 16
36142	1952399	25	28	32	25,6	6,8	13,5	0,6	3,7	10 / 16
36143	1952401	32	35	40	32	7,8	13,5	0,6	2,5	10 / 16
36144	1952402	40	42	47	39	8,8	13,5	0,6	0	10 / 16
36145	1952403	50	54	59	51	10,2	13,5	0,8	0	10 / 16
36146	1952404	65	76,1	78	72,1	12,2	13,5	0,8	0	10 / 16
36147	1952405	80	88,9	91	84,9	13,8	13,5	1	0	10 / 16
36148	1952406	100	108	110	104	15,8	13,5	1	0	10 / 16

Bestilles i tillegg

- Løsfleis

Kompensatorer

Geberit Mapress Syrefast Stål aksialkompensator med muffe

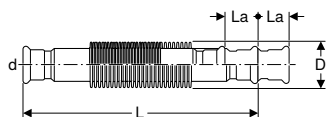

click & scan

Art. nr.	NRF nr.	DN	d, ø [mm]	D [cm]	La [mm]	L [cm]	Z [cm]
33932	1950163	12	15	2,6	7	15,1	11,1
33933	1950164	15	18	2,6	7	14,7	10,7
33934	1950165	20	22	3,1	11	10,6	6,4
33935	1950166	25	28	3,9	13	12	7,4
33936	1950167	32	35	4,6	13	13,9	8,7
33937	1950168	40	42	5,9	13	14,9	8,9
33938	1950169	50	54	7	18	17,6	10,6
33939	1950171	65	76,1	8,8	22	26,2	15,6
33940	1950172	80	88,9	11,7	23	28,6	16,6
33941	1950173	100	108	14,4	23	54,2	39,2

Gjennomføringer

Geberit Mapress Syrefast Stål skott- og takgjennomføring med to spissender

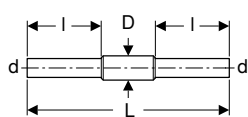

click & scan

Art. nr.	NRF nr.	DN	d, ø [mm]	D [cm]	L [cm]	I [cm]
90980	1952396	12	15	2,5	45	16,5
90981	1952397	15	18	3	45	16,5
90982	1952093	20	22	3,4	45	16,5
90983	1952095	25	28	3,8	45	16,5
90984	1952097	32	35	4,5	45	16,5
90985	1952099	40	42	5,4	45	16,5
90986	1952102	50	54	7	45	16,5
90987	1952104	65	76,1	8,9	45	16,5
90988	1952106	80	88,9	10,8	45	16,5
90989	1952108	100	108	13,3	45	16,5

Endedeksler

Geberit Mapress Syrefast Stål kappe



click & scan

Art. nr.	NRF nr.	DN	d, ø [mm]	L [cm]	Z [cm]
33212	1952111	12	15	2,3	0,3
33213	1952112	15	18	2,3	0,3
33214	1952113	20	22	2,4	0,3
33215	1952114	25	28	2,6	0,3
33216	1952115	32	35	2,9	0,3
33217	1952116	40	42	3,3	0,3
33218	1952117	50	54	3,8	0,3
33219	1952118	65	76,1	6	0,7
33220	1952119	80	88,9	6,7	0,7
33221	1952121	100	108	8,2	0,7

Tilkoblinger

Geberit Mapress Syrefast Stål tilkoplingsbend 90°

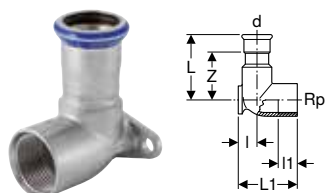

click & scan

Art. nr.	NRF nr.	DN	d, ø [mm]	Rp ["]	arc [°]	L [cm]	l [cm]	l1 [cm]	Z [cm]
L1 / Lengde: 4,3 cm									
33013		10 / 15	12	1/2"	90	4,6	1,3	1,5	2,9
33403	1951259	12 / 15	15	1/2"	90	5	1,3	1,5	3
33405	1951263	15	18	1/2"	90	5	1,3	1,5	3
L1 / Lengde: 4,7 cm									
33406		20	22	1/2"	90	5,4	1,7	1,6	2,9
L1 / Lengde: 5,1 cm									
33407	1951266	20	22	3/4"	90	5,4	1,7	1,6	3,3

Geberit Mapress Syrefast Stål hjørnetilkoplingsbend 90°

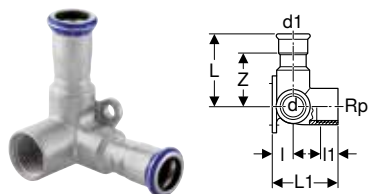

click & scan

Art. nr.	NRF nr.	DN	d, ø [mm]	Rp ["]	d1, ø [mm]	arc [°]	L [cm]	L1 [cm]	l [cm]	l1 [cm]	Z [cm]
33503	1951289	12 / 15 / 12	15	1/2"	15	90	6	4,3	1,3	1,5	4

Geberit Mapress Syrefast Stål, gass

Systemrør 1.4401



Geberit Mapress systemrør i syrefast stål, CrNiMo

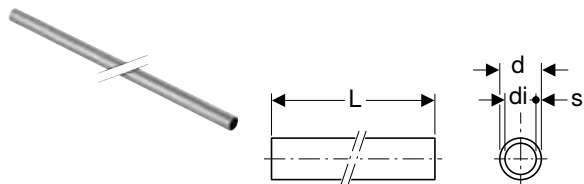

click & scan

Art. nr.	NRF nr.	DN	d, ø [mm]	di, ø [mm]	s [mm]	L [m]
39002	1950006	12	15	13	1	6
39003	1950009	15	18	16	1	6
39004	1950016	20	22	19,6	1,2	6
39005	1950019	25	28	25,6	1,2	6
39006	1950023	32	35	32	1,5	6
39007	1950026	40	42	39	1,5	6
39008	1950029	50	54	51	1,5	6
39009	1950063	65	76,1	72,1	2	6
39010	1950066	80	88,9	84,9	2	6
39011	1950069	100	108	104	2	6

Tilbehør

- Geberit Mapress rørkutter R → s. 291
- Geberit Mapress avgrader → s. 292
- Geberit Mapress merkemal med merkepenn → s. 292

Rørnippel

Geberit Mapress Syrefast Stål rørnippel

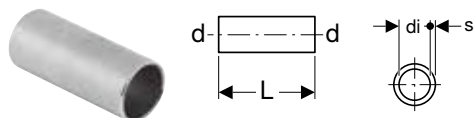

click & scan

Art. nr.	DN	d, ø [mm]	di, ø [mm]	s [mm]	L [cm]
32050	12	15	13	1	5
32051	15	18	16	1	5
32052	20	22	19,6	1,2	5,2
32053	25	28	25,6	1,2	5,6
32054	32	35	32	1,5	6,2
32055	40	42	39	1,5	8
32056	50	54	51	1,5	9
32057	65	76,1	72,1	2	13,6
32058	80	88,9	84,9	2	15
32059	100	108	104	2	18

Muffer

Geberit Mapress Syrefast Stål muffe (gass)



click & scan

Art. nr.	NRF nr.	DN	d, ø [mm]	L [cm]	Z [cm]
34101	8710173	12	15	4,8	0,8
34102	8710174	15	18	4,8	0,8
34103	8710175	20	22	5	0,8
34104	8710176	25	28	5,4	0,8
34105	8710177	32	35	6,2	1
34106	8710178	40	42	7,1	1,1
34107	8710179	50	54	8,3	1,3
34248	8710781	65	76,1	12,7	2,1
34249	8710782	80	88,9	14,5	2,5
34250	8710783	100	108	17,6	2,6

Geberit Mapress Syrefast Stål glidemuffe (gass)

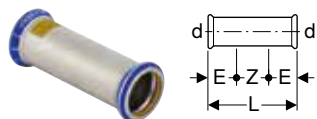

click & scan

Art. nr.	NRF nr.	DN	d, ø [mm]	E [cm]	L [cm]	Z [cm]
34108	8710203	12	15	2,5	8	3
34109	8710204	15	18	2,5	8	3
34110	8710205	20	22	2,5	8,4	3,4
34111	8710206	25	28	3	9,1	3,1
34112	8710207	32	35	3	10,2	4,2
34113	8710208	40	42	4	12	4
34114	8710209	50	54	4	14	6
34162	8710776	65	76,1	6	23	11
34121	8710774	80	88,9	7	26	12
34122	8710775	100	108	8	31	15

Reduksjoner

Geberit Mapress Syrefast Stål reduksjon med spissende (gass)

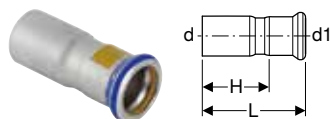

click & scan

Art. nr.	NRF nr.	DN	d, ø [mm]	d1, ø [mm]	L [cm]	H [cm]
34115	8710153	15 / 12	18	15	5,5	3,5
34116	8710154	20 / 12	22	15	5,9	3,9
34117	8710155	20 / 15	22	18	5,7	3,7
34118	8710156	25 / 12	28	15	6,6	4,6
34119	8710157	25 / 15	28	18	6,4	4,4
34120	8710158	25 / 20	28	22	6	3,9
34123	8710159	32 / 20	35	22	7,1	5
34124	8710161	32 / 25	35	28	6,8	4,5
34127	8710793	40 / 20	42	22	8,2	6,1
34128	8710162	40 / 25	42	28	8,3	6
34129	8710163	40 / 32	42	35	7,7	5,1
34132	8710794	50 / 20	54	22	9,5	7,4
34133	8710164	50 / 25	54	28	11	8,7
34134	8710165	50 / 32	54	35	10,6	8
34135	8710166	50 / 40	54	42	9,2	6,2
34296	8710798	65 / 50	76,1	54	14,6	11,1
34297	8710799	80 / 50	88,9	54	16,2	12,8
34298	8710801	80 / 65	88,9	76,1	16,1	10,8
34259	8710795	100 / 50	108	54	17,2	13,7
34260	8710796	100 / 65	108	76,1	18,4	13,1
34261	8710797	100 / 80	108	88,9	20,3	14,3

Bend

Geberit Mapress Syrefast Stål bend (gass)

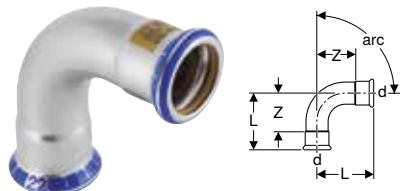

click & scan

Art. nr.	NRF nr.	DN	d, ø [mm]	L [cm]	Z [cm]
arc / Vinkel: 45°					
34014	8710043	12	15	2,8	0,8
34015	8710044	15	18	2,9	0,9
34016	8710045	20	22	3,2	1,1
34017	8710046	25	28	3,7	1,4
34193	8710047	32	35	4,3	1,7
34194	8710048	40	42	5,1	2,1
34195	8710049	50	54	6,2	2,7
34447	8710766	65	76,1	10,3	5
34448	8710767	80	88,9	11,7	5,7
34449	8710768	100	108	14,3	6,8
arc / Vinkel: 90°					
34000	8710003	12	15	4,9	2,9
34001	8710004	15	18	5,3	3,3
34002	8710005	20	22	6,1	4
34003	8710006	25	28	5,7	3,4
34187	8710007	32	35	6,8	4,2
34188	8710008	40	42	8	5
34189	8710009	50	54	10	6,5
34441	8710759	65	76,1	15,9	10,6
34442	8710761	80	88,9	18,5	12,5
34443	8710762	100	108	23	15,5

Geberit Mapress Syrefast Stål bend med spissende (gass)

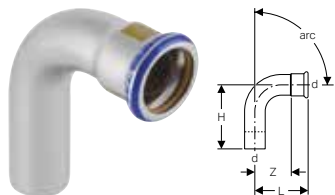

click & scan

Art. nr.	NRF nr.	DN	d, ø [mm]	L [cm]	H [cm]	Z [cm]
arc / Vinkel: 45°						
34021	8710063	12	15	2,8	3,6	0,8
34022	8710064	15	18	2,9	3,6	0,9
34023	8710065	20	22	3,2	3,9	1,1
34024	8710066	25	28	3,7	4,4	1,4
34196	8710067	32	35	4,3	5	1,7
34197	8710068	40	42	5,1	5,9	2,1
34198	8710069	50	54	6,2	7	2,7
34450	8710769	65	76,1	10,3	11,1	5
34451	8710771	80	88,9	11,7	12,8	5,7
34452	8710772	100	108	14,3	15,8	6,8
arc / Vinkel: 90°						
34007	8710023	12	15	4,9	5,9	2,9
34008	8710024	15	18	5,3	6,1	3,3
34009	8710025	20	22	6,1	7	4
34010	8710026	25	28	5,7	6,3	3,4
34190	8710027	32	35	6,8	7,4	4,2
34191	8710028	40	42	8	8,8	5
34192	8710029	50	54	10	10,8	6,5
34444	8710763	65	76,1	15,9	16,7	10,6
34445	8710764	80	88,9	18,5	19,5	12,5
34446	8710765	100	108	23	24,1	15,5

Geberit Mapress Syrefast Stål passbend

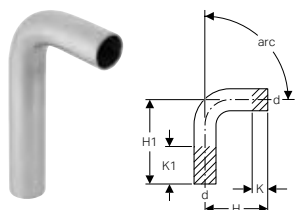

click & scan

Art. nr.	NRF nr.	DN	d, ø [mm]	H [cm]	H1 [cm]	K [cm]	K1 maks. [cm]
arc / Vinkel: 15°							
30892	1952368	12	15	4	11	0	7
30893	1952369	15	18	4	11,2	0	7,1
30894	1952371	20	22	4,1	11,4	0	7,3
30905	1951756	25	28	4,3	11,9	0	7,6
30906	1951758	32	35	4,1	11,8	0	7,7
30907	1951761	40	42	4,7	13,7	0	9
30908	1951763	50	54	5,5	14,9	0	9,4
30009	1952365	65	76,1	8,4	20,4	0	12
30010	1952366	80	88,9	9,5	22	0	12,5
30011	1952367	100	108	11,7	25,4	0	13,7
arc / Vinkel: 30°							
30932	1952375	12	15	4,3	11,3	0	7
30933	1952376	15	18	4,4	11,6	0	7,1
30934	1952377	20	22	4,6	11,8	0	7,2
30935	1951796	25	28	4,8	12,4	0	7,6
30936	1951798	32	35	4,6	12,3	0	7,7
30937	1951801	40	42	5,4	14,4	0	9
30938	1951803	50	54	6,3	15,7	0	9,4
30029	1952372	65	76,1	9,7	21,7	0	12
30030	1952373	80	88,9	11,1	23,6	0	12,5
30031	1952374	100	108	13,6	27,3	0	13,7



Art. nr.	NRF nr.	DN	d, ø [mm]	H [cm]	H1 [cm]	K [cm]	K1 maks. [cm]
arc / Vinkel: 45°							
30872	1952382	12	15	4,5	11,6	0	7,1
30873	1952383	15	18	4,2	11,7	0	7,5
30874	1952384	20	22	5,2	12,3	0	7,1
30875	1952385	25	28	5,6	13,1	0	7,5
30876	1952386	32	35	5,3	12,9	0	7,6
30877	1952387	40	42	6,1	15,1	0	9
30878	1952388	50	54	7,3	16,7	0	9,4
30049	1952378	65	76,1	11,1	23	0	11,9
30050	1952379	80	88,9	13	25,2	0	12,2
30051	1952381	100	108	15,7	29,4	0	13,7
arc / Vinkel: 60°							
30942	1952389	12	15	5	12	0	7
30943	1952391	15	18	5,3	12,4	0	7,1
30944	1952392	20	22	5,6	12,8	0	7,2
30955	1951836	25	28	6,1	13,7	0	7,6
30956	1951838	32	35	5,9	13,6	0	7,7
30957	1951841	40	42	6,9	15,9	0	9
30958	1951843	50	54	8,3	17,7	0	9,4
30069		65	76,1	12,6	24,6	0	12
30070		80	88,9	14,6	27,1	0	12,5
30071		100	108	18	31,7	0	13,7
arc / Vinkel: 90°							
30402	1950449	12	15	5,9	12,9	0	7
30403	1950453	15	18	6,1	13,3	0	7,2
30404	1950456	20	22	7	14,2	0	7,2
30405	1950459	25	28	7,9	15,5	0	7,6
30406	1950463	32	35	7,7	15,4	0	7,7
30407	1950466	40	42	9	18	0	9
30408	1950469	50	54	11,1	20,5	0	9,4
30089	1952393	65	76,1	16,6	28,6	0	12
30090	1952394	80	88,9	19,4	31,9	0	12,5
30091	1952395	100	108	24	37,7	0	13,7

Geberit Mapress Syrefast Stål langt passbend 90°

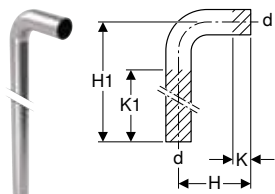

click & scan

Art. nr.	NRF nr.	DN	d, ø [mm]	arc [°]	H [cm]	H1 [cm]	K [cm]	K1 maks. [cm]
30414	1952326	20	22	90	7	84	1,5	70
30415	1952327	25	28	90	8	85	1,7	77

Geberit Mapress Syrefast Stål bypass-rør

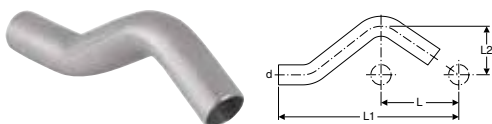

click & scan

Art. nr.	NRF nr.	DN	d, ø [mm]	L [cm]	L1 [cm]	L2 [cm]
30802	1951359	12	15	6	16,5	3,2
30803	1951363	15	18	6	16,6	3,3
30804	1951366	20	22	6	16,8	3,5
30805	1951369	25	28	6	17,9	3,8

T-rør

Geberit Mapress Syrefast Stål T-rør likt (gass)

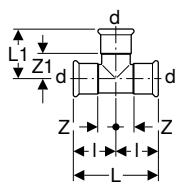

click & scan

Art. nr.	NRF nr.	DN	d, ø [mm]	arc [°]	L [cm]	L1 [cm]	I [cm]	Z [cm]	Z1 [cm]
34028	8710083	12	15	90	6,4	3,9	3,2	1,2	1,9
34029	8710084	15	18	90	6,8	4,1	3,4	1,4	2,1
34030	8710085	20	22	90	7,4	4,4	3,7	1,6	2,3
34031	8710086	25	28	90	8,4	5	4,2	1,9	2,7
34032	8710087	32	35	90	10	5,7	5	2,4	3,1
34033	8710088	40	42	90	11,4	6,5	5,7	2,7	3,5
34034	8710089	50	54	90	13,8	7,7	6,9	3,4	4,2
34285	8710829	65	76,1	90	23	11	11,5	6,2	5,7
34286	8710831	80	88,9	90	26	12,7	13	7	6,7
34287	8710832	100	108	90	31	15,3	15,5	8	7,8

Geberit Mapress Syrefast Stål T-rør redusert (gass)

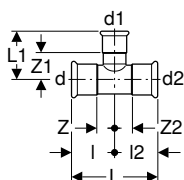

click & scan

Art. nr.	NRF nr.	DN	d, ø [mm]	d1, ø [mm]	d2, ø [mm]	arc [°]	L [cm]	L1 [cm]	I [cm]	I2 [cm]	Z [cm]	Z1 [cm]	Z2 [cm]
34035	8710103	15 / 12 / 15	18	15	18	90	6,8	4,1	3,4	3,4	1,4	2,1	1,4
34036	8710105	20 / 12 / 20	22	15	22	90	7,4	4,3	3,7	3,7	1,6	2,3	1,6
34037	8710107	20 / 15 / 20	22	18	22	90	7,4	4,3	3,7	3,7	1,6	2,3	1,6
34038	8710108	25 / 12 / 25	28	15	28	90	8,4	4,6	4,2	4,2	1,9	2,6	1,9
34039	8710109	25 / 15 / 25	28	18	28	90	8,4	4,6	4,2	4,2	1,9	2,6	1,9
34040	8710111	25 / 20 / 25	28	22	28	90	8,4	4,7	4,2	4,2	1,9	2,6	1,9
34041	8710112	32 / 12 / 32	35	15	35	90	10	4,9	5	5	2,4	2,9	2,4
34042	8710113	32 / 15 / 32	35	18	35	90	10	4,9	5	5	2,4	2,9	2,4
34043	8710114	32 / 20 / 32	35	22	35	90	10	5	5	5	2,4	2,9	2,4
34044	8710115	32 / 25 / 32	35	28	35	90	10	5,3	5	5	2,4	3	2,4
34140	8710821	40 / 12 / 40	42	15	42	90	11,4	5,3	5,7	5,7	2,7	3,3	2,7
34141	8710822	40 / 15 / 40	42	18	42	90	11,4	5,3	5,7	5,7	2,7	3,3	2,7
34045	8710116	40 / 20 / 40	42	22	42	90	11,4	5,4	5,7	5,7	2,7	3,3	2,7
34046	8710117	40 / 25 / 40	42	28	42	90	11,4	5,7	5,7	5,7	2,7	3,4	2,7
34047	8710118	40 / 32 / 40	42	35	42	90	11,4	6,1	5,7	5,7	2,7	3,5	2,7
34048	8710119	50 / 20 / 50	54	22	54	90	13,8	6	6,9	6,9	3,4	3,9	3,4
34049	8710121	50 / 25 / 50	54	28	54	90	13,8	6,3	6,9	6,9	3,4	4	3,4
34050	8710122	50 / 32 / 50	54	35	54	90	13,8	6,7	6,9	6,9	3,4	4,1	3,4
34051	8710123	50 / 40 / 50	54	42	54	90	13,8	7,1	6,9	6,9	3,4	4,1	3,4
34062	8710803	65 / 20 / 65	76,1	22	76,1	90	23	7,2	11,5	11,5	6,2	5,1	6,2
34065	8710804	65 / 25 / 65	76,1	28	76,1	90	23	7,5	11,5	11,5	6,2	5,2	6,2
34079	8710805	65 / 32 / 65	76,1	35	76,1	90	23	7,9	11,5	11,5	6,2	5,3	6,2
34080	8710806	65 / 40 / 65	76,1	42	76,1	90	23	8,3	11,5	11,5	6,2	5,3	6,2
34097	8710815	65 / 50 / 65	76,1	54	76,1	90	23	8,9	11,5	11,5	6,2	5,4	6,2
34081	8710807	80 / 20 / 80	88,9	22	88,9	90	26	7,8	13	13	7	5,7	7
34082	8710808	80 / 25 / 80	88,9	28	88,9	90	26	8,1	13	13	7	5,8	7
34085	8710809	80 / 32 / 80	88,9	35	88,9	90	26	8,5	13	13	7	5,9	7
34088	8710811	80 / 40 / 80	88,9	42	88,9	90	26	8,9	13	13	7	5,9	7
34098	8710816	80 / 50 / 80	88,9	54	88,9	90	26	9,5	13	13	7	6	7
34094	8710812	100 / 20 / 100	108	22	108	90	31	8,8	15,5	15,5	8	6,7	8
34095	8710813	100 / 25 / 100	108	28	108	90	31	9,1	15,5	15,5	8	6,8	8
34096	8710814	100 / 32 / 100	108	35	108	90	31	9,5	15,5	15,5	8	6,9	8
34125	8710818	100 / 40 / 100	108	42	108	90	31	9,9	15,5	15,5	8	6,9	8
34099	8710817	100 / 50 / 100	108	54	108	90	31	10,5	15,5	15,5	8	7	8

Geberit Mapress Syrefast Stål T-rør med innvendige gjenger (gass)

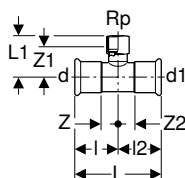

click & scan



Art. nr.	NRF nr.	DN	d, ø [mm]	Rp ["]	d1, ø [mm]	arc [°]	L [cm]	L1 [cm]	I [cm]	I2 [cm]	Z [cm]	Z1 [cm]	Z2 [cm]
34052	8710133	12 / 15 / 12	15	1/2"	15	90	6,4	4	3,2	3,2	1,2	2,7	1,2
34053	8710134	15	18	1/2"	18	90	6,8	4,2	3,4	3,4	1,4	2,9	1,4
34054	8710135	15 / 20 / 15	18	3/4"	18	90	6,8	4,4	3,4	3,4	1,4	2,9	1,4
34055	8710136	20 / 15 / 20	22	1/2"	22	90	7,4	4,3	3,7	3,7	1,6	3	1,6
34056	8710137	20	22	3/4"	22	90	7,4	4,6	3,7	3,7	1,6	3,1	1,6
34057	8710138	25 / 15 / 25	28	1/2"	28	90	8,4	4,6	4,2	4,2	1,9	3,3	1,9
34058	8710139	25 / 20 / 25	28	3/4"	28	90	8,4	4,9	4,2	4,2	1,9	3,4	1,9
34059	8710141	32 / 15 / 32	35	1/2"	35	90	10	5	5	5	2,4	3,7	2,4
34060	8710142	32 / 20 / 32	35	3/4"	35	90	10	5,3	5	5	2,4	3,8	2,4
34061	8710143	40 / 15 / 40	42	1/2"	42	90	11,4	5,3	5,7	5,7	2,7	4	2,7
34126	8710819	40 / 20 / 40	42	3/4"	42	90	11,4	5,6	5,7	5,7	2,7	4,1	2,7
34063	8710144	50 / 15 / 50	54	1/2"	54	90	13,8	5,9	6,9	6,9	3,4	4,6	3,4
34264	8710145	50 / 20 / 50	54	3/4"	54	90	13,8	6,2	6,9	6,9	3,4	4,7	3,4
34265	8710146	50	54	2"	54	90	13,8	7,9	6,9	6,9	3,4	5,6	3,4
34266	8710823	65 / 20 / 65	76,1	3/4"	76,1	90	23	7,4	11,5	11,5	6,2	5,9	6,2
34267	8710824	65 / 50 / 65	76,1	2"	76,1	90	23	9,1	11,5	11,5	6,2	6,8	6,2
34268	8710825	80 / 20 / 80	88,9	3/4"	88,9	90	26	8	13	13	7	6,5	7
34269	8710826	80 / 50 / 80	88,9	2"	88,9	90	26	9,7	13	13	7	7,4	7
34270	8710827	100 / 20 / 100	108	3/4"	108	90	31	9	15,5	15,5	8	7,5	8
34271	8710828	100 / 50 / 100	108	2"	108	90	31	10,7	15,5	15,5	8	8,4	8



- Fittings med gjengeforbindelser >2" har redusert driftstrykk: MOP 0.1 / GT 0.1

Overganger uløselige

Geberit Mapress Syrefast Stål overgangsstykke med utvendige gjenger (gass)

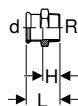

click & scan

Art. nr.	NRF nr.	DN	d, ø [mm]	R ["]	L [cm]	H [cm]
34066	8710223	12 / 15	15	1/2"	4,1	2,1
34142	8710787	12 / 20	15	3/4"	4,3	2,3
34067	8710224	15	18	1/2"	4,2	2,2
34143	8710788	15 / 20	18	3/4"	4,4	2,4
34069	8710225	20 / 15	22	1/2"	4,2	2,1
34070	8710226	20	22	3/4"	4,4	2,3
34346	8710234	20 / 25	22	1"	4,6	2,5
34068	8710784	25 / 20	28	3/4"	4,6	2,3
34071	8710227	25	28	1"	4,8	2,3
34075	8710236	32 / 25	35	1"	5,1	2,5
34072	8710228	32	35	1 1/4"	5,3	2,7
34076	8710237	32 / 40	35	1 1/2"	5,3	2,7
34073	8710229	40	42	1 1/2"	5,7	2,7
34074	8710231	50	54	2"	8,9	5,4
34077	8710785	65	76,1	2 1/2"	12,3	7
34078	8710786	80	88,9	3"	13,7	7,7



- Fittings med gjengeforbindelser >2" har redusert driftstrykk: MOP 0.1 / GT 0.1

Geberit Mapress Syrefast Stål overgangsstykke med utvendige gjenger og spissende

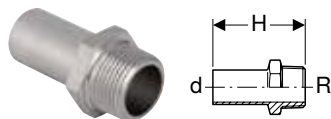

click & scan

Art. nr.	NRF nr.	DN	d, ø [mm]	R ["]	H [cm]
31932	1952336	12 / 15	15	1/2"	5,7
31933	1951963	15	18	1/2"	5,7
31936	1951965	20	22	3/4"	5,9
31937	1951967	25	28	1"	6,6
31938	1951969	32	35	1 1/4"	8
31939	1951972	40	42	1 1/2"	9,1
31940	1951974	50	54	2"	10,2

Geberit Mapress Syrefast Stål overgangsstykke med innvendige gjenger (gass)

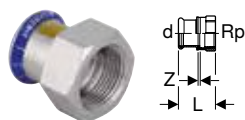

click & scan

Art. nr.	NRF nr.	DN	d, ø [mm]	Rp ["]	L [cm]	Z [cm]
34083	8710243	12 / 15	15	1/2"	3,7	0,4
34169	8710791	12 / 20	15	3/4"	3,8	0,3
34084	8710244	15	18	1/2"	3,7	0,4
34170	8710792	15 / 20	18	3/4"	3,8	0,3
34086	8710245	20 / 15	22	1/2"	3,6	0,2
34087	8710246	20	22	3/4"	3,9	0,3
34347	8710255	20 / 25	22	1"	4,2	0,4
34089	8710248	25	28	1"	4,4	0,4
34093	8710256	32 / 25	35	1"	4,5	0,2
34090	8710249	32	35	1 1/4"	4,9	0,4
34091	8710251	40	42	1 1/2"	5,3	0,4
34092	8710252	50	54	2"	6,2	0,4

Geberit Mapress Syrefast Stål overgangsstykke med innvendige gjenger og spissende

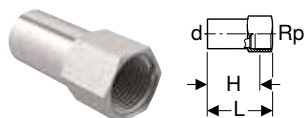

click & scan

Art. nr.	NRF nr.	DN	d, ø [mm]	Rp ["]	L [cm]	H [cm]
33846	1952337	20 / 15	22	1/2"	5,8	4,5
33848	1952338	25 / 15	28	1/2"	6,6	5,3
33850	1952339	32 / 15	35	1/2"	6,9	5,6
33852	1952341	40 / 15	42	1/2"	7,4	6,1
33854	1952342	50 / 15	54	1/2"	7,9	6,6
33860	1952343	65 / 15	76,1	1/2"	10,4	9,1
33862	1952344	80 / 15	88,9	1/2"	11,3	10
33864	1952345	100 / 15	108	1/2"	13,4	12,1

Geberit Mapress Syrefast Stål overgangsstykke med innvendige gjenger og spissende langt

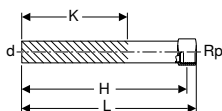

click & scan

Art. nr.	NRF nr.	DN	d, ø [mm]	Rp ["]	L [cm]	H [cm]	K [cm]
90932	1952359	12 / 15	15	1/2"	14,8	13,5	9
90933	1952361	15	18	1/2"	14,8	13,5	9
90934	1952362	15 / 20	18	3/4"	15,2	13,3	9
90935	1952363	20 / 15	22	1/2"	14,8	13,9	8,9
90936	1952364	20	22	3/4"	15,2	13,7	8,7

Geberit Mapress Syrefast Stål albue 90° med utvendige gjenger (gass)

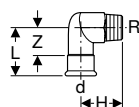

click & scan

Art. nr.	NRF nr.	DN	d, ø [mm]	R ["]	arc [°]	L [cm]	H [cm]	Z [cm]
34149	8710273	12 / 15	15	1/2"	90	5,7	3,7	3,7
34150	8710274	15	18	1/2"	90	5,7	3,9	3,7
34151	8710275	20	22	3/4"	90	6	4,6	3,9
34154	8710758	25 / 20	28	3/4"	90	5,8	4,6	3,5
34152	8710276	25	28	1"	90	6,7	5,4	4,4
34153	8710277	32	35	1 1/4"	90	7,5	6,3	4,9

Geberit Mapress Syrefast Stål albue 90° med innvendige gjenger (gass)

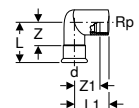

click & scan

Art. nr.	NRF nr.	DN	d, ø [mm]	Rp ["]	arc [°]	L [cm]	L1 [cm]	Z [cm]	Z1 [cm]
34144	8710283	12 / 15	15	1/2"	90	5,7	3,7	3,7	2,4
34145	8710284	15	18	1/2"	90	5,7	3,9	3,7	2,6
34146	8710285	20	22	3/4"	90	6	4,6	3,9	3,1
34147	8710286	25	28	1"	90	6,7	5,4	4,3	3,7
34148	8710287	32	35	1 1/4"	90	7,5	6,3	4,9	4,4

Geberit Mapress Syrefast Stål albue 90° med innvendige gjenger og spissende

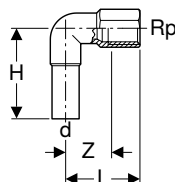

click & scan

Art. nr.	NRF nr.	DN	d, ø [mm]	Rp ["]	arc [°]	L [cm]	H [cm]	Z [cm]
33203	1950359	12 / 15	15	1/2"	90	3,6	5,3	2,3

Overganger og forbindelser, løsbare

Geberit Mapress Syrefast Stål union med utvendige gjenger, unionmutter av CrNi-stål (gass)

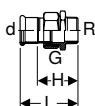

click & scan

Art. nr.	NRF nr.	DN	d, ø [mm]	R ["]	G ["]	L [cm]	H [cm]
34430	8710331	12 / 15	15	1/2"	3/4"	6,4	4,4
34431	8710332	12 / 20	15	3/4"	3/4"	6,6	4,6
34432	8710333	15	18	1/2"	3/4"	6,4	4,4
34433	8710334	15 / 20	18	3/4"	3/4"	6,6	4,6
34434	8710335	20 / 15	22	1/2"	1"	6,7	4,6
34435	8710336	20	22	3/4"	1"	6,8	4,7
34436	8710337	20 / 25	22	1"	1"	7,3	5,2
34437	8710338	25	28	1"	1 1/4"	7,8	5,5
34438	8710339	32	35	1 1/4"	1 1/2"	8,5	5,9
34439	8710341	40	42	1 1/2"	1 3/4"	9	6
34440	8710342	50	54	2"	2 3/8"	10,3	6,8

Geberit Mapress Syrefast Stål union med innvendige gjenger, unionmutter av CrNi-stål (gass)

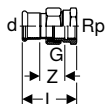

click & scan

Art. nr.	NRF nr.	DN	d, ø [mm]	Rp ["]	G ["]	L [cm]	Z [cm]
34400	8710343	12 / 15	15	1/2"	3/4"	5,9	2,6
34401	8710344	12 / 20	15	3/4"	3/4"	6,1	2,6
34402	8710345	15	18	1/2"	3/4"	5,9	2,6
34403	8710346	15 / 20	18	3/4"	3/4"	6,1	2,6
34404	8710347	20	22	3/4"	1"	6,3	2,7
34405	8710348	20 / 25	22	1"	1"	6,6	2,8
34406	8710349	25	28	1"	1 1/4"	7,1	3,1
34407	8710351	32	35	1 1/4"	1 1/2"	7,7	3,2
34408	8710352	40	42	1 1/2"	1 3/4"	8,2	3,3
34409	8710353	50	54	2"	2 3/8"	9,5	3,7

Geberit Mapress Syrefast Stål overgangsstykke med unionmutter av CrNi-stål (gass)

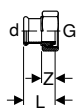

click & scan

Art. nr.	NRF nr.	DN	d, ø [mm]	G ["]	L [cm]	Z [cm]
34158	8710194	20	22	1 1/8"	4,2	1,6
34161	8710789	20	22	1 3/8"	4	1,9
34159	8710195	25	28	1 3/8"	4,5	1,7

Geberit Mapress Syrefast Stål flens PN 10/16, med muffe (gass)

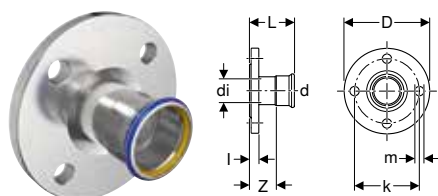

click & scan



Art. nr.	NRF nr.	DN	d, ø [mm]	di, ø [mm]	D [cm]	k [mm]	m [mm]	L [cm]	l [cm]	Z	n [pc.]	PN [bar]
34204	8710773	25 / 20	22	19	11,5	85	14	6,1	1,8	4	4	10 / 16
34205	8710031	25	28	25	11,5	85	14	6,9	1,8	4,6	4	10 / 16
34206	8710032	32	35	32	14	100	18	7,2	1,8	4,6	4	10 / 16
34207	8710033	40	42	39	15	110	18	7,9	1,8	4,9	4	10 / 16
34208	8710034	50	54	51	16,5	125	18	8,7	1,8	5,2	4	10 / 16
34209	8710035	65	76,1	72	18,5	145	18	11,8	1,8	6,5	4	10 / 16
34210	8710036	80	88,9	84,8	20	160	18	12,5	2	6,5	8	10 / 16
34211	8710037	100	108	103,9	22	180	18	13	2	5,5	8	10 / 16

Geberit Mapress Syrefast Stål flens PN 10/16, med spissende

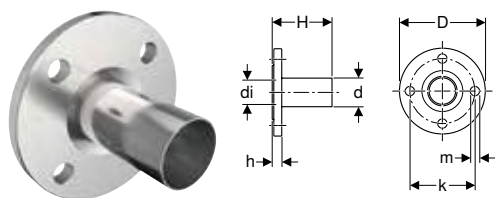

click & scan

Art. nr.	NRF nr.	DN	d, ø [mm]	di, ø [mm]	D [cm]	k [mm]	m [mm]	H [cm]	h [cm]	n [pc.]	PN [bar]
33744	1950088	20	22	19	10,5	75	14	7,9	1,8	4	10 / 16
33745	1950089	25	28	25	11,5	85	14	8,1	1,8	4	10 / 16
33746	1950091	32	35	32	14	100	18	9	1,8	4	10 / 16
33747	1950092	40	42	39	15	110	18	10,8	1,8	4	10 / 16
33748	1952322	50	54	51	16,5	125	18	11,3	1,8	4	10 / 16
33749	1952323	65	76,1	72	18,5	145	18	13,6	1,8	4	10 / 16
33750	1952324	80	88,9	84,8	20	160	18	15,2	2	8	10 / 16
33752	1952325	100	108	103,9	22	180	18	16,5	2	8	10 / 16

Geberit Mapress Syrefast Stål spissende for løsfrens PN 10/16

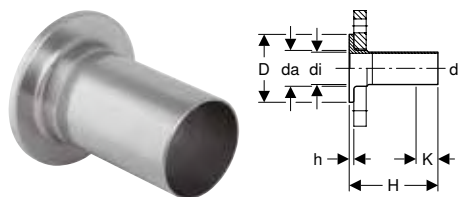

click & scan

Art. nr.	NRF nr.	DN	d, ø [mm]	da [mm]	di, ø [mm]	D [cm]	H [cm]	h [cm]	K [cm]	PN [bar]
36141	1952398	20	22	27	19,6	5,8	13,5	0,6	3,5	10 / 16
36142	1952399	25	28	32	25,6	6,8	13,5	0,6	3,7	10 / 16
36143	1952401	32	35	40	32	7,8	13,5	0,6	2,5	10 / 16
36144	1952402	40	42	47	39	8,8	13,5	0,6	0	10 / 16
36145	1952403	50	54	59	51	10,2	13,5	0,8	0	10 / 16
36146	1952404	65	76,1	78	72,1	12,2	13,5	0,8	0	10 / 16
36147	1952405	80	88,9	91	84,9	13,8	13,5	1	0	10 / 16
36148	1952406	100	108	110	104	15,8	13,5	1	0	10 / 16

Bestilles i tillegg

- Løsfrens

Endedeksler

Geberit Mapress Syrefast Stål kappe (gass)

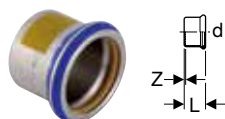

click & scan

Art. nr.	NRF nr.	DN	d, ø [mm]	L [cm]	Z [cm]
34462	8710362	12	15	2,3	0,3
34463	8710363	15	18	2,3	0,3
34464	8710364	20	22	2,4	0,3
34465	8710365	25	28	2,6	0,3
34466	8710366	32	35	2,9	0,3
34467	8710367	40	42	3,3	0,3
34468	8710368	50	54	3,8	0,3
34469	8710777	65	76,1	6	0,7
34470	8710778	80	88,9	6,7	0,7
34471	8710779	100	108	8,2	0,7

Tilkoblinger

Geberit Mapress Syrefast Stål tilkoplingsbend 90° (gass)

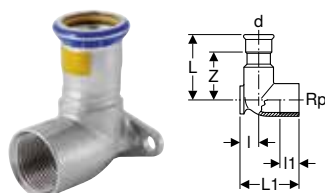

click & scan

Art. nr.	NRF nr.	DN	d, ø [mm]	Rp ["]	arc [°]	L [cm]	l [cm]	l1 [cm]	Z [cm]
L1 / Lengde: 4,3 cm									
34136	8710323	12	15	1/2"	90	5	1,3	1,5	3
34137	8710324	15	18	1/2"	90	5	1,3	1,5	3
L1 / Lengde: 4,7 cm									
34139	8710802	20	22	1/2"	90	5,4	1,7	1,6	2,9
L1 / Lengde: 5,1 cm									
34138	8710325	20	22	3/4"	90	5,4	1,7	1,6	3,3

Tilbehør til Geberit Mapress Syrefast Stål

Beskyttelse for rør og fittings

Geberit beskyttelsestape

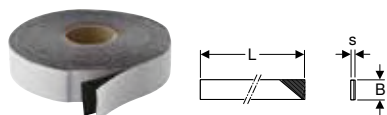

click & scan

Art. nr.	NRF nr.	s [mm]	L [m]	B [cm]
601.813.00.1	2472901	1	12,5	3
601.815.00.1	2472902	1	12,5	5



- Sett på etter trykkontroll

Klammer for rør

Geberit gjengestag

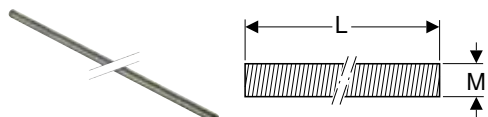

click & scan

Art. nr.	NRF nr.	Farge / overflate	M [mm]	L [cm]
362.834.26.1	2290088	El-forsinket	10	200

Geberit bunnplate rektangulær, to hull, med gjenget rørmuffe M8/M10

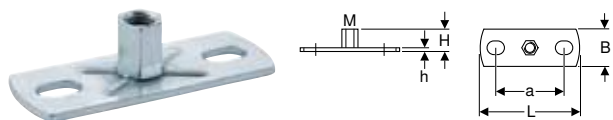

click & scan

Art. nr.	NRF nr.	M [mm]	a [cm]	L [cm]	B [cm]	H [cm]	h [cm]
362.848.26.1	2290373	8 / 10	5,4	8	3	1,9	0,3

Geberit bunnplate rektangulær, to hull, med gjenget rørmuffe M10 / G 1/2"

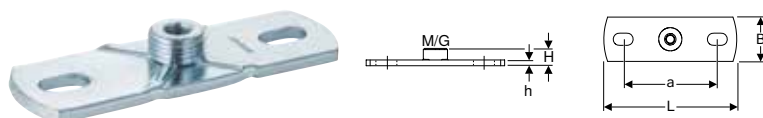

click & scan

Art. nr.	NRF nr.	G ["]	M [mm]	a [cm]	L [cm]	B [cm]	H [cm]	h [cm]
362.851.26.1	2290374	1/2"	10	8,5	12	4	1,5	0,5

Systempakninger

Geberit Mapress tetningsring CIIR svart



click & scan

Art. nr.	NRF nr.	DN	d, ø [mm]
90401	1952142	10	12
90402	1952144	12	15
90403	1952146	15	18
90404	1952148	20	22
90405	1952151	25	28
90406	1952153	32	35
90407	1952155	40	42
90408	1952157	50	54
90409	1952159	65	76,1
90410	1952162	80	88,9
90411	1952164	100	108

Geberit Mapress tetningsring FKM blå



click & scan

Art. nr.	NRF nr.	DN	d, ø [mm]
90881	1952001	10	12
90882	1952003	12	15
90883	1952005	15	18
90884	1952007	20	22
90885	1952009	25	28
90886	1952012	32	35
90887	1952014	40	42
90888	1952016	50	54
90891	1952018	65	76,1
90892	1952021	80	88,9
90893	1952023	100	108

Geberit Mapress tetningsring FKM hvit



click & scan

Art. nr.	NRF nr.	DN	d, ø [mm]
91152	1952485	12	15
91153	1952486	15	18
91154	1952487	20	22
91155	1952488	25	28
91156	1952489	32	35
91157	1952491	40	42
91158	1952492	50	54
91159	1950011	65	76,1
91160	1950012	80	88,9
91161	1950013	100	108

Geberit Mapress planpakning EPDM svart

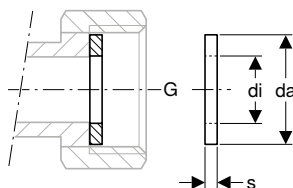

click & scan

Art. nr.	NRF nr.	G ["]	da [mm]	di, ø [mm]	s [mm]
90080	1952243	1/2"	18	10	2
90081	1952244	3/4"	24	13	2
90082	1952245	1"	30	19,6	2
90083	1952246	1 1/4"	39	25,6	2
90084	1952247	1 1/2"	45	32	2
90085	1952248	1 3/4"	50	39	2
90086	1952249	2 3/8"	66	51	3
90088		3"	84,7	76	3
90089		3 1/2"	97	84	3

Geberit Mapress planpakning FPM grønn

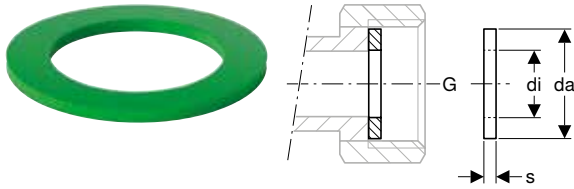

click & scan



Art. nr.	NRF nr.	G ["]	da [mm]	di, ø [mm]	s [mm]
90092	1952225	3/4"	24	13	2
90094	1952227	1"	30	19,6	2
90095	1952228	1 1/4"	39	25,6	2
90096	1952229	1 1/2"	45	32	2
90097	1952231	1 3/4"	50	39	2
90098	1952232	2 3/8"	66	51	2

Ny

Geberit Mapress planpakning fiberkomposittmateriale



click & scan

Art. nr.	G ["]	da [mm]	di, ø [mm]	s [mm]
600.079.00.1	1/2"	18,4	10	2
600.080.00.1	3/4"	23,9	13	2
600.081.00.1	1"	30	19,6	2
600.082.00.1	1 1/8"	34,7	21	2
600.083.00.1	1 1/4"	38	25	2
600.084.00.1	1 1/4"	38,7	25,6	2
600.085.00.1	1 1/2"	44,6	32	2
600.087.00.1	1 3/4"	50,5	39	2
600.088.00.1	2"	56,4	42	2
600.089.00.1	2 1/4"	62,5	42	2
600.090.00.1	2 3/8"	66,2	51	2
600.091.00.1	2 1/2"	72	54	2
600.092.00.1	2 3/4"	78,3	57	2
600.093.00.1	3"	84,7	72,1	2
600.094.00.1	3 1/2"	97,1	84,9	2

Kan leveres fra april 2024

- Erstatning for art. nr. 600.021.00.1, 600.022.00.1, 90072, 600.023.00.1, 90074, 600.024.00.1, 90075, 600.025.00.1, 600.026.00.1, 90076, 600.027.00.1, 90077, 600.028.00.1, 600.029.00.1, 600.030.00.1, 90078, 600.031.00.1, 600.032.00.1, 600.033.00.1, 600.034.00.1



Geberit Mapress Kobber



Bruksoversikt – Geberit Mapress Kobber	75
Geberit Mapress Kobber.....	76
Muffer.....	76
Reduksjoner.....	77
Bend	78
T-stykker.....	80
Innvendig sirkulasjon.....	81
Kryss	82
Overganger uløselige	82
Overganger og forbindelser, løsbare	86
Endedeksler.....	89
Tilkoblinger	89
Geberit Mapress Kobber, forkrommet	90
Muffer.....	90
Reduksjoner.....	90
Bend	91
T-stykker.....	92
Overganger uløselige	92
Geberit Mapress Kobber, gass.....	93
Muffer.....	93
Reduksjoner.....	93
Bend	94
T-stykker.....	96
Overganger uløselige	97
Overganger og forbindelser, løsbare	98
Endedeksler.....	99
Tilkoblinger	99
Tilbehør for Geberit Mapress Kobber.....	100
Beskyttelse for rør og fittings	100
Klammer for rør	100
Systempakninger	101

Bruksoversikt – Geberit Mapress Kobber

Geberit Norge, Versjon: oktober 2023

Bruksformål	Driftstemperatur	Maximum operating pressure	Rør	Fittings				
			Kobber	Kobber hvit indikator	Rødgods hvit indikator	Messing hvit indikator	El-forsinket forkopret	
Flytende medier								
For drikkevann kaldt og varmt	0–100 °C	16 bar / 1600 kPa ⁵⁾	✓	✓	✓			
Til avkjøling og oppvarming av vann uten frostvæske	0–100 °C	16 bar / 1600 kPa	✓	✓	✓	✓	✓	✓
Til avkjøling og oppvarming av vann med frostvæske	-30 – +120 °C	16 bar / 1600 kPa	✓	✓	✓	✓	✓	✓
For fjernvarmeoppvarmingsvann ≤ 120 °C	0–120 °C	16 bar / 1600 kPa	✓	✓	✓	✓	✓	
For industri- og prosessvann	0–100 °C	16 bar / 1600 kPa	7)	7)	7)	7)		
For varmebærer (sol)	-25 – +220 °C ³⁾⁴⁾	10 bar / 1000 kPa	✓	✓	✓	✓		
For mineral- og smøreolje	Ved forespørsel	Ved forespørsel	7)	7)	7)			
For drivstoff (f.eks. diesel)	Ved forespørsel	Ved forespørsel	7)	7)	7)			
Gassmedier								
For trykkluft (renhetsklasse olje 2–3) ¹⁾	0–100 °C	12 bar / 1200 kPa ⁶⁾	✓	✓	✓			
For trykkluft (renhetsklasse olje 0–X) ¹⁾	0–100 °C	12 bar / 1200 kPa ⁶⁾	✓	✓	✓			
For undertrykk ²⁾	0–100 °C	Abs. ≥ 0,2 bar/20 kPa	✓	✓	✓			
For inertgasser (f.eks. nitrogen)	0–100 °C	12 bar / 1200 kPa ⁶⁾	✓	✓	✓	✓		
Ford naturgass	-20 – +70 °C	MOP 5 / GT 1	✓	✓	✓	✓		
For flytende gass	-20 – +70 °C	MOP 5 / GT 1	✓	✓	✓	✓		

✓ Bruk er generelt godkjent når de definerte tilleggskravene iht. fotnotene er oppfylt

¹⁾ Brukbart undertrykk for Geberit rørsystemer:

Det brukbare undertrykket skyldes lufttrykket på installasjonsstedet minus det absolutte trykket på 200 mbar.
Eksempel: 980 mbar lufttrykk - 200 mbar absolutt trykk = 780 mbar brukbart undertrykk i rørsystemet

²⁾ Utnyttbart undertrykk for Geberit rørledningssystemer:

Utnyttbart undertrykk fremgår av lufttrykket på installasjonsstedet minus absoluttrykket fra 200 mbar.
Eksempel: 980 mbar lufttrykk - 200 mbar absoluttrykk = 780 mbar utnyttbart undertrykk i rørledningssystemet

³⁾ Levetid med kollektorstopp: 200 t/a ved 180 °C, 60 t/a ved 200 °C, total 500 t/levetid ved 220 °C

⁴⁾ Bruk av hemmere, anti korrosjonsmidler, frostvæske bare etter godkjenning av Geberit

⁵⁾ 10 bar / 1000 kPa for MasterFix og MeplaFix

⁶⁾ Godkjent inntil d54 mm

⁷⁾ Etter godkjenning fra Geberit

⁸⁾ Bruk av hemmere, antikorrosjonsmidler, frostvæske bare etter godkjenning av Geberit

⁹⁾ Renhetsklasse olje iht. ISO 8573-1:2010E; du finner informasjon om fuktighet og partikler i teknisk informasjon "Geberit rørledningssystemer for trykkluftinstallasjoner"



- For hver bruk må driftsbetingelsene i de retningsgivende tillatelsene, normene og tekniske regelverkene overholdes. Disse kan avvike fra angivelsene ovenfor.

	Tetningsringer				Planpakninger for skrueforbindelser			Flenspakninger	
	CIIR svart	EPDM svart	FKM blå	HNBR gul	EPDM svart	FPM grønn	Fiberkomposittmateriale	Fiberkomposittmateriale	
	✓	✓			✓		✓	✓	
	✓ ⁸⁾	✓			✓		✓	✓	
	✓ ⁸⁾						✓	✓	
	✓ ⁸⁾	✓				✓	✓	✓	
	7)	7)			7)		7)	7)	
			✓			✓	✓	✓	
			7)			7)	7)	7)	
			7)			7)	7)	7)	
	✓ ⁹⁾				✓ ⁹⁾		✓	✓	
			✓ ⁹⁾			✓ ⁹⁾	✓	✓	
	✓	✓					✓	✓	
	✓				✓		✓	✓	
				✓			✓	✓	
				✓			✓	✓	



Geberit Mapress Kobber

Muffer

Geberit Mapress Kobber muffe



click & scan

Art. nr.	NRF nr.	DN	d, ø [mm]	L [cm]	Z [cm]
62001	5052506	10	12	4,2	0,8
62002	5052509	12	15	4,8	0,8
62003	5052513	15	18	4,8	0,8
62004	5052516	20	22	5	0,8
62005	5052519	25	28	5,4	0,8
62006	5052523	32	35	6,2	1
62007	5052526	40	42	7,1	1,1
62008	5052529	50	54	8,3	1,3
62011	5052531	65	76,1	12,7	2,1
62012	5052532	80	88,9	14,5	2,5
62013	5052533	100	108	17,6	2,6

Geberit Mapress Kobber muffe redusert



click & scan

Art. nr.	DN	d, ø [mm]	d1, ø [mm]	L [cm]	Z [cm]
62050	12 / 10	15	12	4	0,3
62055	20 / 12	22	15	4,4	0,3

Geberit Mapress Kobber glidemuffe

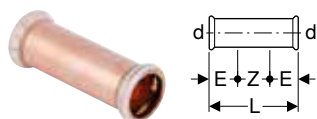

click & scan

Art. nr.	NRF nr.	DN	d, ø [mm]	E [cm]	L [cm]	Z [cm]
62102	5052549	12	15	2,5	8	3
62103	5052553	15	18	2,5	8	3
62104	5052556	20	22	2,5	8,4	3,4
62105	5052559	25	28	3	9,1	3,1
62106	5052563	32	35	3	10,2	4,2
62107	5052566	40	42	4	12	4
62108	5052569	50	54	4	14	6
62111	5052571	65	76,1	5,3	23	12,4
62112	5052572	80	88,9	6	26	14
62113	5052573	100	108	7,5	31	16

Reduksjoner

Geberit Mapress Kobber reduksjon med spissende

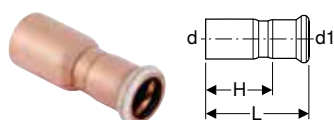

click & scan



Art. nr.	NRF nr.	DN	d, ø [mm]	d1, ø [mm]	L [cm]	H [cm]
62301	5052756	12 / 10	15	12	5	3,3
62302	5052759	15 / 10	18	12	5,4	3,7
62303	5052766	15 / 12	18	15	5,5	3,5
62305	5052769	20 / 12	22	15	5,9	3,9
62306	5052776	20 / 15	22	18	5,7	3,7
62307	5052773	25 / 12	28	15	6,6	4,6
62308	5052779	25 / 15	28	18	6,4	4,4
62309	5052783	25 / 20	28	22	6	3,9
62312	5052786	32 / 20	35	22	7,1	5
62313	5052789	32 / 25	35	28	6,8	4,5
62316	5052791	40 / 20	42	22	8,1	6
62317	5052794	40 / 25	42	28	7,9	5,6
62318	5052793	40 / 32	42	35	7,6	5
62322	5052798	50 / 25	54	28	9,7	7,4
62323	5052801	50 / 32	54	35	9,6	7
62324	5052796	50 / 40	54	42	9,2	6,1
62329	5052802	65 / 32	76,1	35	12,6	10
62330	5052803	65 / 40	76,1	42	12,6	9,6
62331	5052804	65 / 50	76,1	54	14,6	11,1
62333	5052806	80 / 40	88,9	42	14	11
62334	5052807	80 / 50	88,9	54	16,2	12,8
62336	5052808	80 / 65	88,9	76,1	16,1	10,8
62337	5052811	100 / 40	108	42	17,3	14,3
62338	5052812	100 / 50	108	54	17,3	13,8
62340	5052813	100 / 65	108	76,1	18,4	13,1
62341	5052814	100 / 80	108	88,9	20,3	14,3

Bend

Geberit Mapress Kobber bend

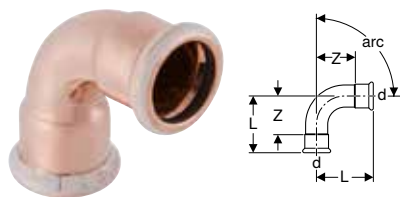

click & scan

Art. nr.	NRF nr.	DN	d, ø [mm]	L [cm]	Z [cm]
arc / Vinkel: 45°					
60601	5052356	10	12	2,6	0,9
60602	5052359	12	15	2,8	0,8
60603	5052363	15	18	2,9	0,9
60604	5052366	20	22	3,2	1,1
60605	5052369	25	28	3,7	1,4
60606	5052373	32	35	4	1,4
60607	5052376	40	42	4,7	1,7
60608	5052379	50	54	5,7	2,2
60611	5052381	65	76,1	10,3	5
60612	5052382	80	88,9	11,7	5,7
60613	5052383	100	108	14,3	6,8
arc / Vinkel: 90°					
60101	5052116	10	12	3,1	1,4
60102	5052119	12	15	3,8	1,8
60103	5052123	15	18	4,2	2,2
60104	5052126	20	22	4,7	2,6
60105	5052129	25	28	5,7	3,4
60106	5052133	32	35	6,5	3,9
60107	5052136	40	42	7,6	4,6
60108	5052139	50	54	9,5	6
60111	5052141	65	76,1	15,9	10,6
60112	5052142	80	88,9	18,5	12,5
60113	5052143	100	108	23	15,5

Geberit Mapress Kobber bend med spissende

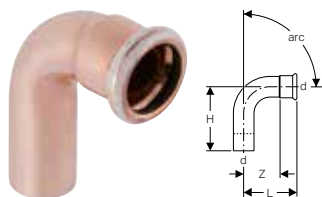

click & scan

Art. nr.	NRF nr.	DN	d, ø [mm]	L [cm]	H [cm]	Z [cm]
arc / Vinkel: 45°						
60701	5052406	10	12	2,6	3,5	0,9
60702	5052409	12	15	2,8	3,8	0,8
60703	5052413	15	18	2,9	3,9	0,9
60704	5052416	20	22	3,2	4,4	1,1
60705	5052419	25	28	3,7	4,5	1,2
60706	5052423	32	35	4	4,9	1,4
60707	5052426	40	42	4,7	5,7	1,7
60708	5052429	50	54	5,7	6,8	2,2
60711	5052431	65	76,1	10,3	11,1	5
60712	5052432	80	88,9	11,7	12,8	5,7
60713	5052433	100	108	14,3	15,8	6,8
arc / Vinkel: 90°						
60301	5052186	10	12	3,1	4,5	1,4
60302	5052189	12	15	3,8	5,1	1,8
60303	5052193	15	18	4,2	5,3	2,2
60304	5052196	20	22	4,7	6	2,6
60305	5052199	25	28	5,7	6,5	3,4
60306	5052203	32	35	6,5	7,4	3,9

Art. nr.	NRF nr.	DN	d, ø [mm]	L [cm]	H [cm]	Z [cm]
60307	5052206	40	42	7,6	8,6	4,6
60308	5052209	50	54	9,5	10,6	6
60311	5052211	65	76,1	15,9	16,7	10,6
60312	5052212	80	88,9	18,5	19,5	12,5
60313	5052213	100	108	23	24,1	15,5



Geberit Mapress Kobber passbend

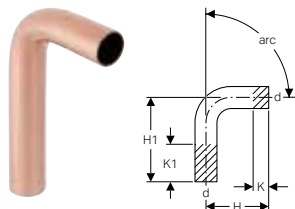

click & scan

Art. nr.	NRF nr.	DN	d, ø [mm]	H [cm]	H1 [cm]	K [cm]	K1 maks. [cm]
arc / Vinkel: 15°							
60905	5052346	25	28	4,3	11,9	0	7,6
60906	5052347	32	35	4,1	11,8	0	7,7
60907	5052348	40	42	4,7	13,7	0	9
60908	5052349	50	54	5,5	14,9	0	9,4
arc / Vinkel: 30°							
60935	5052342	25	28	4,8	12,4	0	7,6
60936	5052343	32	35	4,6	12,3	0	7,7
60937	5052344	40	42	5,4	14,4	0	9
60938	5052345	50	54	6,3	15,7	0	9,4
arc / Vinkel: 45°							
60875	5052149	25	28	4,5	11,8	0	7,3
60876	5052151	32	35	4,9	12,6	0	7,7
60878	5052153	50	54	6,8	16,2	0	9,4
arc / Vinkel: 60°							
60955	5052337	25	28	6,1	13,7	0	7,6
60956	5052338	32	35	5,9	13,6	0	7,7
60957	5052339	40	42	6,9	15,9	0	9
arc / Vinkel: 90°							
60082	5052309	12	15	5,1	11,8	0	6,7
60083	5052313	15	18	5,3	12,2	0	6,9
60084	5052316	20	22	6	12,8	0	6,8
60085	5052319	25	28	6,5	14	0	7,5
60086	5052323	32	35	7,4	15,1	0	7,7
60087	5052326	40	42	8,6	17,6	0	9
60088	5052329	50	54	10,6	20	0	9,4

Geberit Mapress Kobber bypass-rør

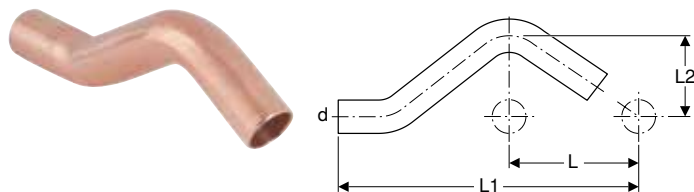

click & scan

Art. nr.	NRF nr.	DN	d, ø [mm]	L [cm]	L1 [cm]	L2 [cm]
60801		10	12	4	15,4	3,4
60802	5053209	12	15	6	16,5	3,2
60803	5053213	15	18	6	16,6	3,3
60804	5053216	20	22	6	16,8	3,5

T-rør

Geberit Mapress Kobber T-rør likt

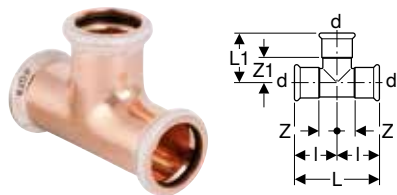

click & scan

Art. nr.	NRF nr.	DN	d, ø [mm]	arc [°]	L [cm]	L1 [cm]	l [cm]	Z [cm]	Z1 [cm]
61000	5052856	10	12	90	6,2	3,1	3,1	1,4	1,4
61002	5052859	12	15	90	6,4	3,1	3,2	1,2	1,2
61003	5052863	15	18	90	6,8	3,4	3,4	1,4	1,4
61004	5052866	20	22	90	7,4	3,7	3,7	1,6	1,6
61005	5052869	25	28	90	8,4	4,2	4,2	1,9	1,9
61006	5052873	32	35	90	10	5,9	5	2,4	3,3
61007	5052876	40	42	90	11,4	6,6	5,7	2,7	3,6
61008	5052879	50	54	90	13,8	7,8	6,9	3,4	4,3
61011	5052881	65	76,1	90	23	11	11,5	6,2	5,7
61012	5052882	80	88,9	90	26	12,7	13	7	6,7
61013	5052883	100	108	90	31	15,3	15,5	8	7,8

Geberit Mapress Kobber T-rør redusert

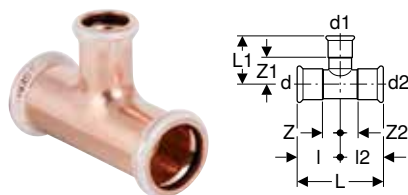

click & scan

Art. nr.	NRF nr.	DN	d, ø [mm]	d1, ø [mm]	d2, ø [mm]	arc [°]	L [cm]	L1 [cm]	l [cm]	l2 [cm]	Z [cm]	Z1 [cm]	Z2 [cm]
61252	5052909	12 / 10 / 12	15	12	15	90	6,4	3,3	3,2	3,2	1,2	1,6	1,2
61253	5052913	15 / 10 / 15	18	12	18	90	6,8	3,5	3,4	3,4	1,4	1,8	1,4
61235	5052914	15 / 12 / 12	18	15	15	90	7,4	3,5	3,4	4	1,4	1,5	2
61254	5052916	15 / 12 / 15	18	15	18	90	6,8	3,5	3,4	3,4	1,4	1,5	1,4
61244		20 / 10 / 20	22	12	22	90	7,4	3,5	3,7	3,7	2,1	1,7	2,1
61240	5052921	20 / 12 / 12	22	15	15	90	8	3,8	3,7	4,3	1,6	1,8	2,3
61256	5052923	20 / 12 / 20	22	15	22	90	7,4	3,8	3,7	3,7	1,6	1,8	1,6
61257	5052926	20 / 15 / 20	22	18	22	90	7,4	3,8	3,7	3,7	1,6	1,8	1,6
61242	5052924	20 / 20 / 12	22	22	15	90	7,4	3,7	3,7	4,5	1,6	1,6	2,5
61259	5052929	25 / 12 / 25	28	15	28	90	8,4	4,1	4,2	4,2	1,9	2,1	1,9
61260	5052933	25 / 15 / 25	28	18	28	90	8,4	4,1	4,2	4,2	1,9	2,1	1,9
61261	5052936	25 / 20 / 25	28	22	28	90	8,4	4,1	4,2	4,2	1,9	2	1,9
61212	5052939	32 / 12 / 32	35	15	35	90	10	5,1	5	5	2,4	3,1	2,4
61213	5052944	32 / 15 / 32	35	18	35	90	10	5	5	5	2,4	3	2,4
61214	5052946	32 / 20 / 32	35	22	35	90	10	5,2	5	5	2,4	3,1	2,4
61215	5052949	32 / 25 / 32	35	28	35	90	10	5,5	5	5	2,4	3,2	2,4
61229		40 / 12 / 40	42	15	42	90	11,4	5,4	5,7	5,7	2,7	3,4	2,7
61218	5052953	40 / 20 / 40	42	22	42	90	11,4	5,5	5,7	5,7	2,7	3,4	2,7
61219	5052956	40 / 25 / 40	42	28	42	90	11,4	5,8	5,7	5,7	2,7	3,5	2,7
61220	5052959	40 / 32 / 40	42	35	42	90	11,4	6,2	5,7	5,7	2,7	3,6	2,7
61227	5052963	50 / 20 / 50	54	22	54	90	13,8	6,1	6,9	6,9	3,4	4	3,4
61228	5052966	50 / 25 / 50	54	28	54	90	13,8	6,4	6,9	6,9	3,4	4,1	3,4
61225	5052969	50 / 32 / 50	54	35	54	90	13,8	6,8	6,9	6,9	3,4	4,2	3,4
61226	5052973	50 / 40 / 50	54	42	54	90	13,8	7,2	6,9	6,9	3,4	4,2	3,4
61283	5052975	65 / 20 / 65	76,1	22	76,1	90	23	7,2	11,5	11,5	6,2	5,1	6,2
61284	5052976	65 / 32 / 65	76,1	35	76,1	90	23	7,9	11,5	11,5	6,2	5,3	6,2
61285	5052977	65 / 40 / 65	76,1	42	76,1	90	23	8,3	11,5	11,5	6,2	5,3	6,2
61286	5052978	65 / 50 / 65	76,1	54	76,1	90	23	8,9	11,5	11,5	6,2	5,4	6,2
61288	5052981	80 / 20 / 80	88,9	22	88,9	90	26	7,8	13	13	7	5,7	7
61289	5052982	80 / 40 / 80	88,9	42	88,9	90	26	8,9	13	13	7	5,9	7
61290	5052983	80 / 50 / 80	88,9	54	88,9	90	26	9,5	13	13	7	6	7
61292	5052984	80 / 65 / 80	88,9	76,1	88,9	90	26	11,6	13	13	7	6,3	7

Art. nr.	NRF nr.	DN	d, ø [mm]	d1, ø [mm]	d2, ø [mm]	arc [°]	L [cm]	L1 [cm]	I [cm]	I2 [cm]	Z [cm]	Z1 [cm]	Z2 [cm]
61293	5052985	100 / 20 / 100	108	22	108	90	31	8,8	15,5	15,5	8	6,7	8
61294	5052986	100 / 50 / 100	108	54	108	90	31	10,5	15,5	15,5	8	7	8
61296	5052987	100 / 65 / 100	108	76,1	108	90	31	12,6	15,5	15,5	8	7,3	8
61297	5052988	100 / 80 / 100	108	88,9	108	90	31	13,7	15,5	15,5	8	7,7	8

Geberit Mapress Kobber T-rør med innvendige gjenger

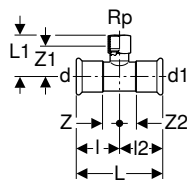

click & scan

Art. nr.	NRF nr.	DN	d, ø [mm]	Rp [°]	d1, ø [mm]	arc [°]	L [cm]	L1 [cm]	I [cm]	I2 [cm]	Z [cm]	Z1 [cm]	Z2 [cm]
61352	5053046	10 / 15 / 10	12	1/2"	12	90	6,8	2,4	3,4	3,4	1,7	1,1	1,7
61354	5053049	12 / 15 / 12	15	1/2"	15	90	6,8	2,6	3,4	3,4	1,4	1,3	1,4
61355	5053053	15	18	1/2"	18	90	8,2	2,4	4,1	4,1	2,1	1,1	2,1
61357	5053056	20 / 15 / 20	22	1/2"	22	90	8,4	2,6	4,2	4,2	2,1	1,3	2,1
61395	5053057	20	22	3/4"	22	90	9	2,7	4,5	4,5	2,4	1,2	2,4
61359	5053059	25 / 15 / 25	28	1/2"	28	90	8,8	2,9	4,4	4,4	2,1	1,6	2,1
61360	5053061	25 / 20 / 25	28	3/4"	28	90	8,4	3,5	4,2	4,2	1,9	2	1,9
61362	5053063	32 / 15 / 32	35	1/2"	35	90	10	3,5	5	5	2,4	2,2	2,4
61366	5053066	40 / 15 / 40	42	1/2"	42	90	11,4	3,8	5,7	5,7	2,7	2,5	2,7
61370	5053069	50 / 15 / 50	54	1/2"	54	90	13,8	4,4	6,9	6,9	3,4	3,1	3,4

Innvendig sirkulasjon

Geberit Mapress koplingssett for rør i rør til varmtvannssirkulasjon

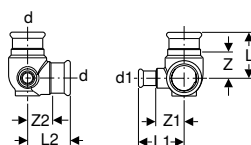

click & scan

Art. nr.	NRF nr.	DN	d, ø [mm]	d1, ø [mm]	arc [°]	L [cm]	L1 [cm]	L2 [cm]	Z [cm]	Z1 [cm]	Z2 [cm]
61275	1951031	25 / 12 / 25	28	15	90	5,8	5,7	5,4	3,5	3,7	3,1
61276	1951032	32 / 12 / 32	35	15	90	5,8	5,7	5,4	3,2	3,7	2,8

Geberit rør for rør i rør til varmtvannssirkulasjon

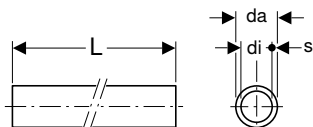

click & scan

Art. nr.	NRF nr.	da [mm]	di, ø [mm]	s [mm]	L [m]
600.101.00.2	1951034	14	11	1,5	50

Geberit koping for rør for rør i rør til varmtvannssirkulasjon

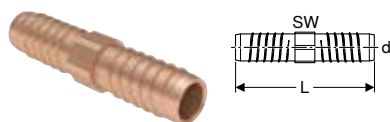

click & scan

Art. nr.	d, ø [mm]	L [cm]	SW [mm]
242.737.00.1	14	5,6	12

Kryss

Geberit Mapress Kobber kryss 30° redusert

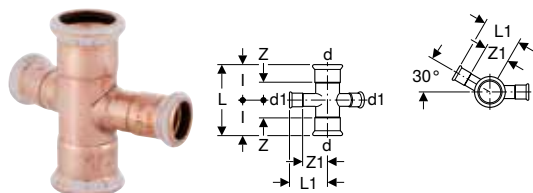

click & scan

Art. nr.	NRF nr.	DN	d, ø [mm]	d1, ø [mm]	arc [°]	L [cm]	L1 [cm]	I [cm]	Z [cm]	Z1 [cm]
61404		15 / 12	18	15	30	6,8	3,9	3,4	1,4	2,2
61406		20 / 12	22	15	30	7,4	4,4	3,7	1,6	2,4
61409	5053156	25 / 12	28	15	30	8,4	4,7	4,2	1,9	2,7

Geberit Mapress Kobber kryss redusert, forskjøvet

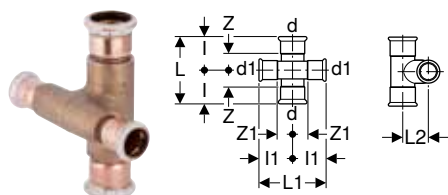

click & scan

Art. nr.	NRF nr.	DN	d, ø [mm]	d1, ø [mm]	arc [°]	L [cm]	L1 [cm]	L2 [cm]	I [cm]	I1 [cm]	Z [cm]	Z1 [cm]
61504	5053143	12	15	15	90	10,8	10,8	2,5	5,4	5,4	3,4	3,4
61505	5053146	15 / 12	18	15	90	10,8	10,8	2,5	5,4	5,4	3,4	3,4
61506	5053149	20 / 12	22	15	90	10,8	11	2,5	5,4	5,5	3,4	3,4

Overganger uløselige

Geberit Mapress Kobber reduksjonsmuffe



click & scan

Art. nr.	NRF nr.	DN	d, ø [mm]	d1, ø [mm]	L [cm]	Z [cm]
62024		15	18	16	4,1	0,1

Geberit FlowFit overgangsstykke til Geberit Mapress, med spissende

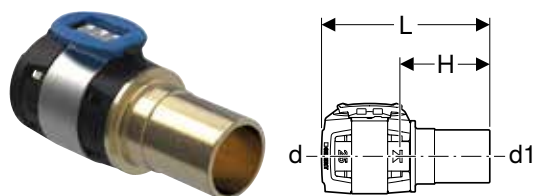

click & scan



Art. nr.	NRF nr.	DN	d, ø [mm]	d1, ø [mm]	L [cm]	H [cm]
620.230.00.1	2473605	12 / 10	16	12	6,8	3,5
620.240.00.1	2473606	12	16	15	6,9	3,6
620.231.00.1	2473607	15 / 12	20	15	6,9	3,6
620.241.00.1	2473615	15	20	18	6,9	3,6
620.242.00.1	2473608	15 / 20	20	22	7	3,7
620.232.00.1	2473609	20	25	22	7	3,7
620.233.00.1	2473611	25	32	28	7,7	4,1
620.234.00.1	2473612	32	40	35	8	4,4
620.235.00.1	2473613	40	50	42	12,8	6,9
620.236.00.1	2473614	50	63	54	13,8	7,5

Geberit Mepla overgangsstykke til Geberit Mapress, med spissende

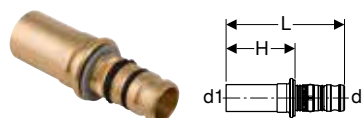

click & scan

Art. nr.	NRF nr.	DN	d, ø [mm]	d1, ø [mm]	L [cm]	H [cm]
601.507.00.5	2472922	12 / 10	16	12	5,8	3,3
601.508.00.5	2472241	12	16	15	5,9	3,4
602.507.00.5	2472248	15 / 12	20	15	6,1	3,4
602.508.00.5	2472242	15	20	18	6,1	3,4
602.509.00.5	2472923	15 / 20	20	22	6,2	3,5
603.508.00.5	2472243	20	26	22	6,7	3,5
604.508.00.5	2472244	25	32	28	6,6	3,7
605.508.00.5	2472245	32	40	35	7,5	4,1
606.508.00.5	2472246	40	50	42	10,1	6,3
607.508.00.5	2472247	50	63	54	13,6	7

Geberit Mapress Kobber overgangsstykke med utvendige gjenger



click & scan

Art. nr.	NRF nr.	DN	d, ø [mm]	R ["]	L [cm]	H [cm]
61701	5052586	10	12	3/8"	3,2	1,5
61745	5052587	10 / 15	12	1/2"	3,6	1,9
61702	5052589	12 / 10	15	3/8"	3,3	1,3
61703	5052593	12 / 15	15	1/2"	3,6	1,6
61714	5052594	12 / 20	15	3/4"	3,8	1,8
61704	5052596	15	18	1/2"	3,7	1,7
61705	5052599	15 / 20	18	3/4"	3,8	1,8
61715	5052601	20 / 15	22	1/2"	3,8	1,7
61707	5052603	20	22	3/4"	3,9	1,8
61716	5052604	20 / 25	22	1"	4,1	2
61717	5052605	25 / 20	28	3/4"	4,2	1,9
61708	5052606	25	28	1"	4,3	2
61718	5052607	25 / 32	28	1 1/4"	4,4	2,1
61719	5052608	32 / 25	35	1"	4,8	2,2
61709	5052609	32	35	1 1/4"	4,9	2,3
61721	5052611	40 / 32	42	1 1/4"	5,8	2,8
61710	5052613	40	42	1 1/2"	5,8	2,8
61711	5052616	50	54	2"	6,3	2,8
61732	5052617	65	76,1	2 1/2"	10,1	4,8
61733	5052618	65 / 80	76,1	3"	10,6	5,3
61734	5052619	80	88,9	3"	11	5

Geberit Mapress Kobber overgangsstykke med utvendige gjenger og spissende

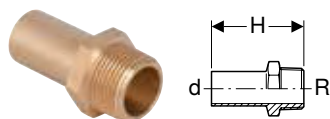

click & scan

Art. nr.	NRF nr.	DN	d, ø [mm]	R ["]	H [cm]
61932	5052144	12 / 15	15	1/2"	5,7
61933	5052145	15	18	1/2"	5,7
61935	5052146	20 / 15	22	1/2"	5,7
61936	5052147	20	22	3/4"	5,9

Geberit Mapress Kobber overgangsstykke med innvendige gjenger

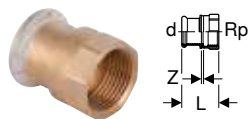

click & scan

Art. nr.	NRF nr.	DN	d, ø [mm]	Rp ["]	L [cm]	Z [cm]
61845	5052637	10	12	3/8"	3,1	0,4
61801	5052636	10 / 15	12	1/2"	3,5	0,5
61846	5052638	12 / 10	15	3/8"	3,3	0,3
61802	5052639	12 / 15	15	1/2"	3,8	0,5
61823	5052641	12 / 20	15	3/4"	3,9	0,4
61803	5052643	15	18	1/2"	3,7	0,4
61804	5052646	15 / 20	18	3/4"	3,9	0,4
61805	5052647	20 / 15	22	1/2"	3,6	0,2
61806	5052649	20	22	3/4"	3,9	0,3
61824	5052651	20 / 25	22	1"	4,3	0,5
61819	5052654	25 / 20	28	3/4"	3,9	0,3
61809	5052656	25	28	1"	4,5	0,5
61825	5052657	25 / 32	28	1 1/4"	4,8	0,6
61820	5052659	32 / 25	35	1"	4,6	0,3
61811	5052658	32	35	1 1/4"	5	0,5
61821	5052662	40 / 32	42	1 1/4"	5,2	0,3
61814	5052661	40	42	1 1/2"	5,4	0,5
61818	5052663	50	54	2"	6,3	0,5

Geberit Mapress Kobber overgangsstykke med innvendige gjenger og spissende

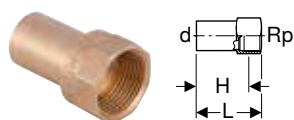

click & scan

Art. nr.	NRF nr.	DN	d, ø [mm]	Rp ["]	L [cm]	H [cm]
63558	8710663	12 / 15	15	1/2"	4,6	3,3
63559	8710664	15	18	1/2"	4,6	3,3
63560	8710665	15 / 20	18	3/4"	4,8	3,3
63561	8710666	20 / 15	22	1/2"	4,6	3,3
63562	5052688	20	22	3/4"	4,9	3,4
63564	5052148	32 / 25	35	1"	6,3	4,6
63565	5052694	50	54	2"	8,5	6,2

Geberit Mapress Kobber albue 90° med utvendige gjenger

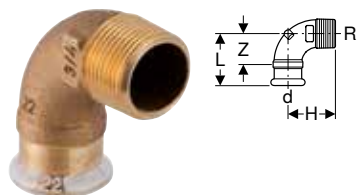

click & scan

Art. nr.	NRF nr.	DN	d, ø [mm]	R ["]	arc [°]	L [cm]	H [cm]	Z [cm]
63892	5052226	10	12	3/8"	90	3	2,5	1,3
63893	5052227	10 / 15	12	1/2"	90	3,2	3,1	1,5
63894	5052229	12 / 10	15	3/8"	90	3,2	2,7	1,2
63873	5052233	12 / 15	15	1/2"	90	3,5	3,1	1,5
63884	5052236	15	18	1/2"	90	3,5	3,4	1,5
63895	5052237	15 / 20	18	3/4"	90	3,8	3,3	1,8
63885	5052239	20	22	3/4"	90	4,8	4,4	2,7
63886	5052243	25	28	1"	90	5,8	5,3	3,5
63887	5052246	32	35	1 1/4"	90	5,5	4,7	2,9
63888	5052249	40	42	1 1/2"	90	6,2	5,1	3,2
63889	5052253	50	54	2"	90	7	6,3	3,5

Geberit Mapress Kobber albue 90° med innvendige gjenger

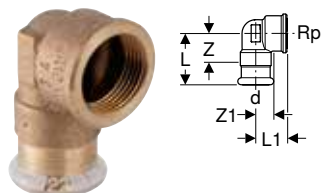

click & scan

Art. nr.	NRF nr.	DN	d, ø [mm]	Rp ["]	arc [°]	L [cm]	L1 [cm]	Z [cm]	Z1 [cm]
63860	5053253	10	12	3/8"	90	3,2	2,3	1,5	1,3
63861	5053256	10 / 15	12	1/2"	90	3,4	2,4	1,7	1,1
63862	5053259	12 / 10	15	3/8"	90	3,3	2,4	1,3	1,4
63853	5053263	12 / 15	15	1/2"	90	3,6	2,7	1,6	1,4
63854	5053266	15	18	1/2"	90	3,6	3	1,6	1,7
63863	5053269	15 / 20	18	3/4"	90	3,8	3,1	1,8	1,6
63864	5053271	20 / 15	22	1/2"	90	3,8	3,2	1,7	1,9
63855	5053273	20	22	3/4"	90	4,5	2,7	2,4	1,2
63856	5053279	25	28	1"	90	5,1	3,3	2,8	1,6
63857	5053283	32	35	1 1/4"	90	5,5	4,5	2,9	2,6
63865	5053286	40	42	1 1/2"	90	6,7	5,2	3,7	3,3
63866	5053289	50	54	2"	90	7,4	6	3,9	3,7

Overganger og forbindelser, løsbare

Geberit Mapress Kobber union med utvendige gjenger



click & scan

Art. nr.	NRF nr.	DN	d, ø [mm]	R ["]	G ["]	L [cm]	H [cm]
65531	5053081	10	12	3/8"	1/2"	5,1	3,4
65540	5053082	10 / 15	12	1/2"	1/2"	5,5	3,8
65532	5053083	12 / 15	15	1/2"	3/4"	6,1	4,1
65541	5053085	12 / 20	15	3/4"	3/4"	6,3	4,3
65533	5053084	15	18	1/2"	3/4"	6,1	4,1
65542	5053087	15 / 20	18	3/4"	3/4"	6,3	4,3
65534	5053088	20 / 15	22	1/2"	1"	6,7	4,6
65543	5053086	20	22	3/4"	1"	6,8	4,7
65544	5053091	20 / 25	22	1"	1"	6,9	4,8
65535	5053089	25	28	1"	1 1/4"	7,5	5,2
65536	5053093	32	35	1 1/4"	1 1/2"	8	5,4
65537	5053096	40	42	1 1/2"	1 3/4"	8,5	5,5
65538	5053099	50	54	2"	2 3/8"	9,7	6,2

Geberit Mapress Kobber union med innvendige gjenger



click & scan

Art. nr.	NRF nr.	DN	d, ø [mm]	Rp ["]	G ["]	L [cm]	Z [cm]
65481	5053376	10 / 15	12	1/2"	1/2"	5,2	2,2
65482	5053379	12 / 15	15	1/2"	3/4"	5	1,7
65490	5053383	12 / 20	15	3/4"	3/4"	5,9	2,4
65483	5053386	15	18	1/2"	3/4"	5	1,7
65491	5053389	15 / 20	18	3/4"	3/4"	5,9	2,4
65484	5053393	20	22	3/4"	1"	6,2	2,6
65492	5053396	20 / 25	22	1"	1"	6,6	2,8
65485	5053399	25	28	1"	1 1/4"	6,3	2,3
65486	5053403	32	35	1 1/4"	1 1/2"	7,5	3
65487	5053406	40	42	1 1/2"	1 3/4"	7,9	3
65488	5053409	50	54	2"	2 3/8"	8,5	2,7

Geberit Mapress Kobber overgangs-koplingsalbu 90° med innvendige gjenger

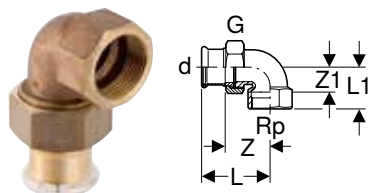

click & scan



Art. nr.	NRF nr.	DN	d, ø [mm]	Rp ["]	G ["]	arc [°]	L [cm]	L1 [cm]	Z [cm]	Z1 [cm]
65382	5053429	12 / 15	15	1/2"	3/4"	90	5,7	3,2	3,7	1,9
65392	5053433	15	18	1/2"	3/4"	90	5,7	3,2	3,7	1,9
65384	5053439	20	22	3/4"	1"	90	6,4	3,6	4,3	2,1
65385	5053446	25	28	1"	1 1/4"	90	7,2	4,4	4,9	2,7
65386	5053449	32	35	1 1/4"	1 1/2"	90	8	5	5,4	3,1
65387	5053453	40	42	1 1/2"	1 3/4"	90	8,7	5,3	5,7	3,4
65388	5053456	50	54	2"	2 3/8"	90	10,1	6,4	6,6	4,1

Geberit Mapress Kobber overgangsstykke med unionmutter

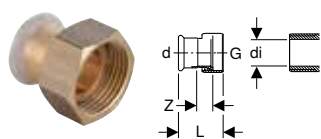

click & scan

Art. nr.	NRF nr.	DN	d, ø [mm]	G ["]	di, ø [mm]	L [cm]	Z [cm]
65081		10	12	1/2"	10	3,2	0,9
65182		12	15	1/2"	10	5,1	2,5
65082	5053336	12	15	3/4"	13	3,7	1,1
65083	5053339	15	18	3/4"	13	3,7	1,1
65040		15	18	1"	20	3,9	1,3
65084	5053343	20	22	1"	20	4	1,1
65044		20	22	1 1/4"	26	4,3	1,3
65045		20	22	1 1/2"	32	4,4	1,3
65046		25	28	1"	20	5,5	1,3
65085	5053346	25	28	1 1/4"	26	4,4	1,3
65050		25	28	1 1/2"	32	4,6	1,3
65086	5053349	32	35	1 1/2"	32	4,8	1,3
65051		32	35	2"	42	4,8	1,2
65087	5053353	40	42	1 3/4"	39	5,2	1,3
65052		40	42	2"	42	5,4	1,4
65053		40	42	2 1/4"	42	5,6	1,4
65088	5053356	50	54	2 3/8"	51	5,8	1,5
65054		50	54	2 1/2"	54	6,3	1,4
65090	5052664	65	76,1	3"	73	9,1	2,5
65091	5052665	80	88,9	3 1/2"	84	9,8	2,4

Geberit Mapress-overgang med kompresjonsringmontering for bølgerør, NPW, innsettsende

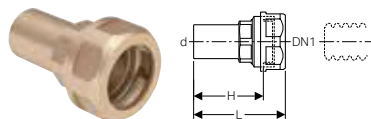

click & scan

Art. nr.	DN	DN1	d, ø [mm]	L [cm]	H [cm]	PN [bar]
22421	12	16	15	6,4	4,9	10
22431	12	20	15	6,7	5,2	10
22422	15	16	18	6,4	4,9	10
22432	15	20	18	6,7	5,2	10
22423	20	16	22	6,8	5,9	10
22433	20	20	22	6,8	5,9	10
22444	25	25	28	6,8	5,9	10



- Hvis skruelingen og bølgerøret har ulikt driftstrykk, er det laveste driftstrykket retningsgivende

Geberit Mapress Kobber spissende for løsfleis PN 10/16

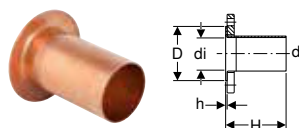

click & scan

Art. nr.	NRF nr.	DN	d, ø [mm]	di, ø [mm]	D [cm]	H [cm]	h [cm]	PN [bar]
63706		25	28	25,2	6,8	8,1	0,2	10 / 16
63707		32	35	32	7,8	9,3	0,2	10 / 16
63708		40	42	39	8,8	10,9	0,2	10 / 16
63709		50	54	51	10,2	10,9	0,2	10 / 16
63711	5052621	65	76,1	72,1	12,2	14,5	0,2	10 / 16
63712	5052622	80	88,9	84,9	13,8	15,2	0,2	10 / 16
63713	5052623	100	108	104	15,8	17,4	0,3	10 / 16

Bestilles i tillegg

- Geberit Mapress løsfleis PN 10/16 → s. 88

Geberit Mapress løsfleis PN 10/16



click & scan

Art. nr.	NRF nr.	DN	di, ø [mm]	D [cm]	k [mm]	m [mm]	H [cm]	n [pc.]	PN [bar]
23715	1083881	25	31	11,5	85	14	1,6	4	10 / 16
23716	1083882	32	39	14	100	18	1,6	4	10 / 16
23717	1083883	40	47	15	115	18	1,6	4	10 / 16
23718	1083884	50	59	16,5	125	18	1,6	4	10 / 16
23719	1082351	65	82	18,5	145	18	1,6	4	10 / 16
23720	1082352	80	96	20	160	18	1,8	8	10 / 16
23721	1082353	100	119	22	180	18	1,8	8	10 / 16

Endedeksler

Geberit Mapress Kobber kappe



click & scan

Art. nr.	NRF nr.	DN	d, ø [mm]	L [cm]	Z [cm]
60231	5052114	10	12	2	0,3
60232	5053229	12	15	2,3	0,3
60233	5053231	15	18	2,3	0,3
60234	5053232	20	22	2,5	0,4
60235	5053233	25	28	2,7	0,4
60236	5053234	32	35	3	0,4
60237	5053235	40	42	3,4	0,4
60238	5053236	50	54	3,9	0,4
60240	5053237	65	76,1	6,4	1,1
60241	5053238	80	88,9	7,1	1,1
60242	5053239	100	108	8,6	1,1

Tilkoblinger

Geberit Mapress Kobber tilkopplingsbend 90°

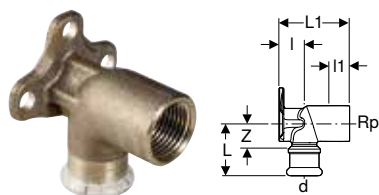

click & scan

Art. nr.	NRF nr.	DN	d, ø [mm]	Rp ["]	arc [°]	L [cm]	I [cm]	I1 [cm]	Z [cm]
L1 / Lengde: 3,6 cm									
63458		10 / 15	12	1/2"	90	3,4	1,8	1,8	1,7
63459		12 / 15	15	1/2"	90	3,8	1,8	1,8	1,8
63460		15	18	1/2"	90	3,8	1,8	1,8	1,8
L1 / Lengde: 5,2 cm									
63452	5053303	10 / 15	12	1/2"	90	3,4	1,8	3,4	1,7
63453	5053306	12 / 15	15	1/2"	90	3,4	1,8	3,4	1,4
63455	5053313	15	18	1/2"	90	3,4	1,8	3,4	1,4
63457	5053316	20	22	3/4"	90	3,7	2,2	3	1,6

Geberit Mapress Kobber dobbel tilkopplingsbend 90°

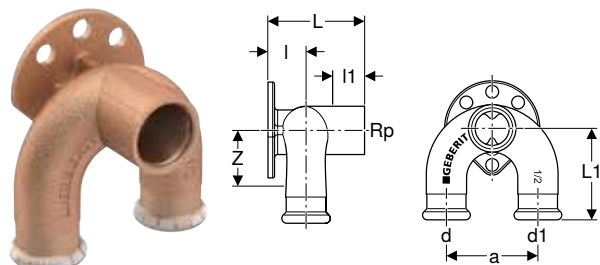

click & scan

Art. nr.	DN	d, ø [mm]	Rp ["]	d1, ø [mm]	arc [°]	a [cm]	L1 [cm]	I [cm]	I1 [cm]	Z [cm]
L / Lengde: 5,2 cm										
63462	12	15	1/2"	15	90	5	5	1,8	2,4	3
63463	15	18	1/2"	18	90	5	5	2	2,4	3
63464	20	22	1/2"	22	90	5	5	1,8	2,4	2,9

Geberit Mapress Kobber

Geberit Mapress Kobber, forkrommet
Muffer

Geberit Mapress Kobber tilkoplingsbend 90° formontert, dobbel

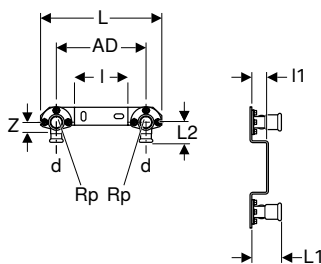

click & scan

Art. nr.	DN	d, ø [mm]	Rp ["]	arc [°]	AD min. [cm]	L [cm]	L2 [cm]	I [cm]	I1 [cm]	Z [cm]
L1 / Lengde: 3,6 cm										
63473	12	15	1/2"	90	15,3	20,5	3,8	9	1,8	1,8

Geberit Mapress Kobber, forkrommet

Muffer

Geberit Mapress Kobber muffe (forkrommet)

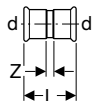

click & scan

Art. nr.	NRF nr.	DN	d, ø [mm]	L [cm]	Z [cm]
60018	5052714	10	12	4,2	0,8
60019	5052715	12	15	4,8	0,8
60029	5052725	15	18	4,8	0,8

Geberit Mapress Kobber glidemuffe (forkrommet)

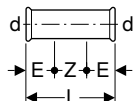

click & scan

Art. nr.	NRF nr.	DN	d, ø [mm]	E [cm]	L [cm]	Z [cm]
60020	5052716	12	15	2,5	8	3

Reduksjoner

Geberit Mapress Kobber reduksjon med spissende (forkrommet)

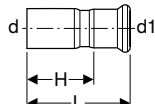

click & scan

Art. nr.	NRF nr.	DN	d, ø [mm]	d1, ø [mm]	L [cm]	H [cm]
60021	5052717	12 / 10	15	12	5	3,3
60022	5052718	15 / 10	18	12	5,4	3,7
60023	5052719	15 / 12	18	15	5,5	3,5

Bend

Geberit Mapress Kobber bend (forkrommet)

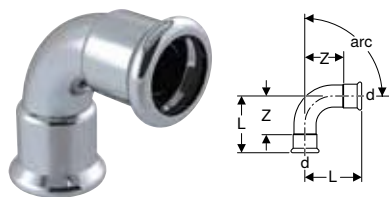

click & scan



Art. nr.	NRF nr.	DN	d, ø [mm]	L [cm]	Z [cm]
arc / Vinkel: 45°					
60005	5052699	10	12	2,6	0,9
60006	5052701	12	15	2,8	0,8
60030	5052726	15	18	2,9	0,9
arc / Vinkel: 90°					
60001	5052695	10	12	3,1	1,4
60002	5052696	12	15	3,8	1,8
60026	5052722	15	18	4,2	2,2

Geberit Mapress Kobber bend med spissende (forkrommet)

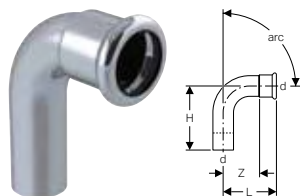

click & scan

Art. nr.	NRF nr.	DN	d, ø [mm]	L [cm]	H [cm]	Z [cm]
arc / Vinkel: 45°						
60007	5052702	10	12	2,6	3,5	0,9
60008	5052703	12	15	2,6	3,8	0,8
60031	5052727	15	18	2,9	3,9	0,9
arc / Vinkel: 90°						
60025	5052721	10	12	3,1	4,5	1,4
60003	5052697	12	15	3,8	5,1	1,8
60004	5052698	15	18	4,2	5,3	2,2

Geberit Mapress Kobber bypass-rør (forkrommet)

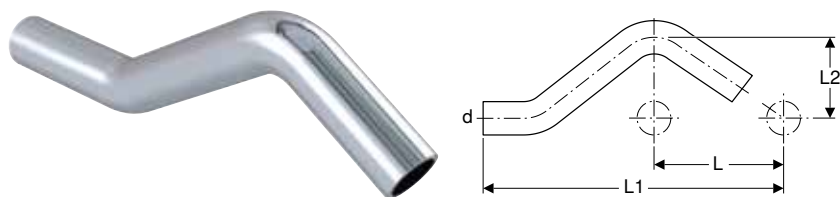

click & scan

Art. nr.	NRF nr.	DN	d, ø [mm]	L [cm]	L1 [cm]	L2 [cm]
60032	5052728	10	12	4	15,4	3,4
60009	5052704	12	15	6	16,5	3,2

T-rør

Geberit Mapress Kobber T-rør likt (forkrommet)

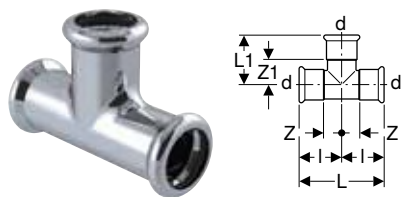

click & scan

Art. nr.	NRF nr.	DN	d, ø [mm]	arc [°]	L [cm]	L1 [cm]	I [cm]	Z [cm]	Z1 [cm]
60010	5052705	10	12	90	6,2	3,1	3,1	1,4	1,4
60011	5052706	12	15	90	6,4	3,1	3,2	1,2	1,2
60027	5052723	15	18	90	6,8	3,4	3,4	1,4	1,4

Geberit Mapress Kobber T-rør redusert (forkrommet)

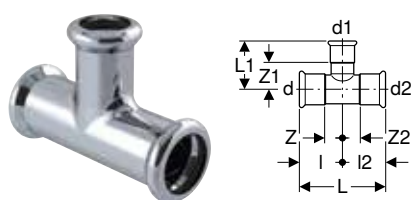

click & scan

Art. nr.	NRF nr.	DN	d, ø [mm]	d1, ø [mm]	d2, ø [mm]	arc [°]	L [cm]	L1 [cm]	I [cm]	I2 [cm]	Z [cm]	Z1 [cm]	Z2 [cm]
60033	5052729	12 / 10 / 10	15	12	12	90	6,7	3,3	3,2	3,5	2	1,6	1,7
60012	5052707	12 / 10 / 12	15	12	15	90	6,4	3,3	3,2	3,2	1,2	1,6	1,2
60013	5052708	15 / 10 / 15	18	12	18	90	6,8	3,5	3,4	3,4	1,4	1,8	1,4
60028	5052724	15 / 12 / 15	18	15	18	90	6,8	3,5	3,4	3,4	1,4	1,5	1,4

Overganger uløselige

Geberit Mapress Kobber overgangsstykke med utvendige gjenger (forkrommet)



click & scan

Art. nr.	NRF nr.	DN	d, ø [mm]	R [°]	L [cm]	H [cm]
60034	5052731	10	12	3/8"	3,2	1,5
60015	5052711	10 / 15	12	1/2"	3,6	1,9
60035	5052732	12 / 10	15	3/8"	3,3	1,3
60014	5052709	12 / 15	15	1/2"	3,6	1,6

Geberit Mapress Kobber overgangsstykke med innvendige gjenger (forkrommet)



click & scan

Art. nr.	NRF nr.	DN	d, ø [mm]	Rp [°]	L [cm]	Z [cm]
60016	5052712	10 / 15	12	1/2"	3,5	0,5
60017	5052713	12 / 15	15	1/2"	3,8	0,5

Geberit Mapress Kobber, gass

Muffer

Geberit Mapress Kobber muffe (gass)



click & scan

Art. nr.	NRF nr.	DN	d, ø [mm]	L [cm]	Z [cm]
34601	8710573	12	15	4,8	0,8
34602	8710574	15	18	4,8	0,8
34603	8710575	20	22	5	0,8
34604	8710576	25	28	5,4	0,8
34605	8710577	32	35	6,2	1
34606	8710578	40	42	7,1	1,1
34607	8710579	50	54	8,3	1,3

Geberit Mapress Kobber glidemuffe (gass)

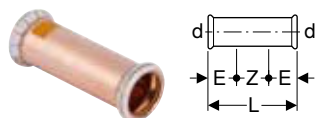

click & scan

Art. nr.	NRF nr.	DN	d, ø [mm]	E [cm]	L [cm]	Z [cm]
34608	8710603	12	15	2,5	8	3
34609	8710604	15	18	2,5	8	3
34610	8710605	20	22	2,5	8,4	3,4
34611	8710606	25	28	3	9,1	3,1
34612	8710607	32	35	3	10,2	4,2
34613	8710608	40	42	4	12	4
34614	8710609	50	54	4	14	6

Reduksjoner

Geberit Mapress Kobber reduksjon med spissende (gass)

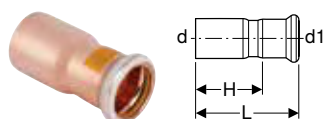

click & scan

Art. nr.	NRF nr.	DN	d, ø [mm]	d1, ø [mm]	L [cm]	H [cm]
34615	8710553	15 / 12	18	15	5,5	3,5
34616	8710554	20 / 12	22	15	5,9	3,9
34617	8710555	20 / 15	22	18	5,7	3,7
34618	8710556	25 / 12	28	15	6,6	4,6
34619	8710557	25 / 15	28	18	6,4	4,4
34620	8710558	25 / 20	28	22	6	3,9
34623	8710559	32 / 20	35	22	7,1	5
34624	8710561	32 / 25	35	28	6,8	4,5
34625	8710562	40 / 25	42	28	7,9	5,6
34626	8710563	40 / 32	42	35	7,6	5
34627	8710564	50 / 25	54	28	11	8,7
34628	8710565	50 / 32	54	35	9,6	7
34629	8710566	50 / 40	54	42	9,2	6,2

Bend

Geberit Mapress Kobber bend (gass)

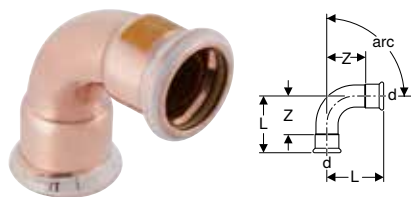

click & scan

Art. nr.	NRF nr.	DN	d, ø [mm]	L [cm]	Z [cm]
arc / Vinkel: 45°					
34514	8710443	12	15	2,8	0,8
34515	8710444	15	18	2,9	0,9
34516	8710445	20	22	3,2	1,1
34517	8710446	25	28	3,7	1,4
34518	8710447	32	35	4	1,4
34519	8710448	40	42	4,7	1,7
34520	8710449	50	54	5,7	2,2
arc / Vinkel: 90°					
34500	8710403	12	15	3,8	1,8
34501	8710404	15	18	4,2	2,2
34502	8710405	20	22	4,7	2,6
34503	8710406	25	28	5,7	3,4
34504	8710407	32	35	6,5	3,9
34505	8710408	40	42	7,6	4,6
34506	8710409	50	54	9,5	6

Geberit Mapress Kobber bend med spissende (gass)

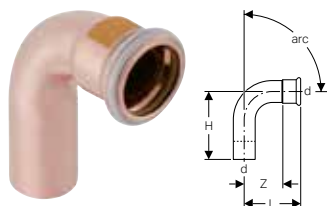

click & scan

Art. nr.	NRF nr.	DN	d, ø [mm]	L [cm]	H [cm]	Z [cm]
arc / Vinkel: 45°						
34521	8710463	12	15	2,8	3,8	0,8
34522	8710464	15	18	2,9	3,9	0,9
34523	8710465	20	22	3,2	4,4	1,1
34524	8710466	25	28	3,7	4,5	1,4
34525	8710467	32	35	4	4,9	1,4
34526	8710468	40	42	4,7	5,7	1,7
34527	8710469	50	54	5,7	6,8	2,2
arc / Vinkel: 90°						
34507	8710423	12	15	3,8	5,1	1,8
34508	8710424	15	18	4,2	5,3	2,2
34509	8710425	20	22	4,7	6	2,6
34510	8710426	25	28	5,7	6,5	3,4
34511	8710427	32	35	6,5	7,4	3,9
34512	8710428	40	42	7,6	8,6	4,6
34513	8710429	50	54	9,5	10,6	6

Geberit Mapress Kobber passbend

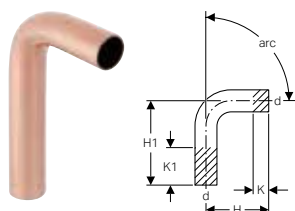

click & scan



Art. nr.	NRF nr.	DN	d, ø [mm]	H [cm]	H1 [cm]	K [cm]	K1 maks. [cm]
arc / Vinkel: 15°							
60905	5052346	25	28	4,3	11,9	0	7,6
60906	5052347	32	35	4,1	11,8	0	7,7
60907	5052348	40	42	4,7	13,7	0	9
60908	5052349	50	54	5,5	14,9	0	9,4
arc / Vinkel: 30°							
60935	5052342	25	28	4,8	12,4	0	7,6
60936	5052343	32	35	4,6	12,3	0	7,7
60937	5052344	40	42	5,4	14,4	0	9
60938	5052345	50	54	6,3	15,7	0	9,4
arc / Vinkel: 45°							
60875	5052149	25	28	4,5	11,8	0	7,3
60876	5052151	32	35	4,9	12,6	0	7,7
60878	5052153	50	54	6,8	16,2	0	9,4
arc / Vinkel: 60°							
60955	5052337	25	28	6,1	13,7	0	7,6
60956	5052338	32	35	5,9	13,6	0	7,7
60957	5052339	40	42	6,9	15,9	0	9
arc / Vinkel: 90°							
60082	5052309	12	15	5,1	11,8	0	6,7
60083	5052313	15	18	5,3	12,2	0	6,9
60084	5052316	20	22	6	12,8	0	6,8
60085	5052319	25	28	6,5	14	0	7,5
60086	5052323	32	35	7,4	15,1	0	7,7
60087	5052326	40	42	8,6	17,6	0	9
60088	5052329	50	54	10,6	20	0	9,4

Geberit Mapress Kobber bypass-rør

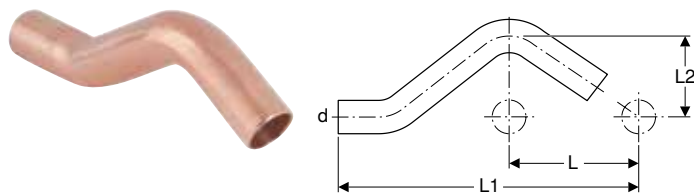

click & scan

Art. nr.	NRF nr.	DN	d, ø [mm]	L [cm]	L1 [cm]	L2 [cm]
60802	5053209	12	15	6	16,5	3,2
60803	5053213	15	18	6	16,6	3,3
60804	5053216	20	22	6	16,8	3,5

T-rør

Geberit Mapress Kobber T-rør likt (gass)

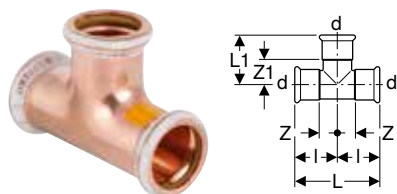

click & scan

Art. nr.	NRF nr.	DN	d, ø [mm]	arc [°]	L [cm]	L1 [cm]	l [cm]	Z [cm]	Z1 [cm]
34528	8710483	12	15	90	6,4	3,2	3,2	1,2	1,2
34529	8710484	15	18	90	6,8	3,4	3,4	1,4	1,4
34530	8710485	20	22	90	7,4	3,7	3,7	1,6	1,6
34531	8710486	25	28	90	8,4	4,2	4,2	1,9	1,9
34532	8710487	32	35	90	10	5,9	5	2,4	3,3
34533	8710488	40	42	90	11,4	6,6	5,7	2,7	3,6
34534	8710489	50	54	90	13,8	7,8	6,9	3,4	4,3

Geberit Mapress Kobber T-rør redusert (gass)

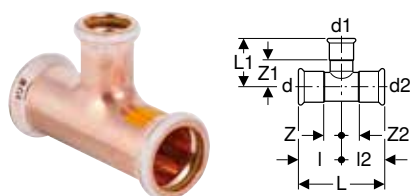

click & scan

Art. nr.	NRF nr.	DN	d, ø [mm]	d1, ø [mm]	d2, ø [mm]	arc [°]	L [cm]	L1 [cm]	l [cm]	l2 [cm]	Z [cm]	Z1 [cm]	Z2 [cm]
34535	8710503	15 / 12 / 15	18	15	18	90	6,8	3,5	3,4	3,4	1,4	1,5	1,4
34553	8710504	20 / 12 / 12	22	15	15	90	8	3,8	3,7	4,3	1,6	1,8	2,3
34536	8710505	20 / 12 / 20	22	15	22	90	7,4	3,8	3,7	3,7	1,6	1,8	1,6
34537	8710507	20 / 15 / 20	22	18	22	90	7,4	3,8	3,7	3,7	1,6	1,8	1,6
34554	8710506	20 / 20 / 12	22	22	15	90	8,3	3,7	3,7	4,6	1,6	1,6	2,6
34588	8710508	25 / 12 / 25	28	15	28	90	8,4	4,1	4,2	4,2	1,9	2,1	1,9
34589	8710509	25 / 15 / 25	28	18	28	90	8,4	4,1	4,2	4,2	1,9	2,1	1,9
34590	8710511	25 / 20 / 25	28	22	28	90	8,4	4,1	4,2	4,2	1,9	2	1,9
34543	8710514	32 / 20 / 32	35	22	35	90	10	5,2	5	5	2,4	3,1	2,4
34544	8710515	32 / 25 / 32	35	28	35	90	10	5,5	5	5	2,4	3,2	2,4
34545	8710516	40 / 20 / 40	42	22	42	90	11,4	5,5	5,7	5,7	2,7	3,4	2,7
34546	8710517	40 / 25 / 40	42	28	42	90	11,4	5,8	5,7	5,7	2,7	3,5	2,7
34547	8710518	40 / 32 / 40	42	35	42	90	11,4	6,2	5,7	5,7	2,7	3,6	2,7
34548	8710519	50 / 20 / 50	54	22	54	90	13,8	6,1	6,9	6,9	3,4	4	3,4
34549	8710521	50 / 25 / 50	54	28	54	90	13,8	6,4	6,9	6,9	3,4	4,1	3,4
34550	8710522	50 / 32 / 50	54	35	54	90	13,8	6,8	6,9	6,9	3,4	4,2	3,4
34551	8710523	50 / 40 / 50	54	42	54	90	13,8	7,2	6,9	6,9	3,4	4,2	3,4

Geberit Mapress Kobber T-rør med innvendige gjenger (gass)

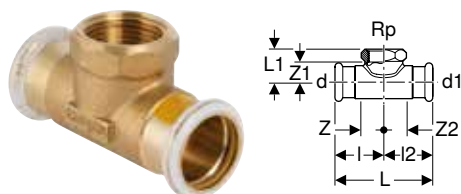

click & scan

Art. nr.	NRF nr.	DN	d, ø [mm]	Rp ["]	d1, ø [mm]	arc [°]	L [cm]	L1 [cm]	l [cm]	l2 [cm]	Z [cm]	Z1 [cm]	Z2 [cm]
34735	8710533	12 / 15 / 12	15	1/2"	15	90	7,4	2,6	3,7	3,7	1,7	1,6	1,7
34736	8710534	15	18	1/2"	18	90	7,4	2,4	3,7	3,7	1,7	1,6	1,7
34737	8710536	20	22	3/4"	22	90	8	2,7	4	4	1,9	2,1	1,9
34738	8710538	25 / 15 / 25	28	1/2"	28	90	8,4	2,9	4,2	4,2	1,9	2,3	1,9
34739	8710539	25 / 20 / 25	28	3/4"	28	90	8,4	3,5	4,2	4,2	1,9	2,1	1,9

Overganger uløselige

Geberit Mapress Kobber overgangsstykke med utvendige gjenger (gass)



click & scan

Art. nr.	NRF nr.	DN	d, ø [mm]	R ["]	L [cm]	H [cm]
34666	8710623	12 / 15	15	1/2"	3,6	1,6
34675	8710632	12 / 20	15	3/4"	3,8	1,8
34667	8710624	15	18	1/2"	3,7	1,7
34676	8710633	15 / 20	18	3/4"	3,8	1,8
34669	8710625	20 / 15	22	1/2"	3,8	1,7
34670	8710626	20	22	3/4"	3,9	1,8
34677	8710634	20 / 25	22	1"	4,1	2
34678	8710635	25 / 20	28	3/4"	4,2	1,9
34671	8710627	25	28	1"	4,3	2
34679	8710636	32 / 25	35	1"	4,8	2,2
34672	8710628	32	35	1 1/4"	4,9	2,3
34673	8710629	40	42	1 1/2"	5,8	2,8
34674	8710631	50	54	2"	6,3	2,8

Geberit Mapress Kobber overgangsstykke med utvendige gjenger og spissende

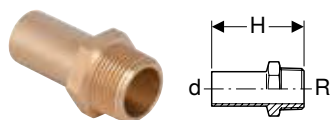

click & scan

Art. nr.	NRF nr.	DN	d, ø [mm]	R ["]	H [cm]
61932	5052144	12 / 15	15	1/2"	5,7
61933	5052145	15	18	1/2"	5,7
61935	5052146	20 / 15	22	1/2"	5,7
61936	5052147	20	22	3/4"	5,9

Geberit Mapress Kobber overgangsstykke med innvendige gjenger (gass)

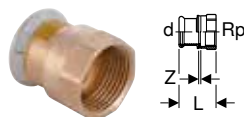

click & scan

Art. nr.	NRF nr.	DN	d, ø [mm]	Rp ["]	L [cm]	Z [cm]
34683	8710643	12 / 15	15	1/2"	3,8	0,5
34693	8710655	12 / 20	15	3/4"	3,9	0,4
34684	8710644	15	18	1/2"	3,7	0,4
34685	8710656	15 / 20	18	3/4"	3,9	0,4
34686	8710645	20 / 15	22	1/2"	3,6	0,2
34687	8710646	20	22	3/4"	3,9	0,3
34688	8710647	20 / 25	22	1"	4,3	0,5
34689	8710648	25	28	1"	4,5	0,5
34690	8710649	32	35	1 1/4"	5	0,5
34691	8710651	40	42	1 1/2"	5,4	0,5
34692	8710652	50	54	2"	6,3	0,5

Geberit Mapress Kobber overgangsstykke med innvendige gjenger og spissende

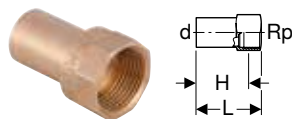

click & scan

Art. nr.	NRF nr.	DN	d, ø [mm]	Rp ["]	L [cm]	H [cm]
63558	8710663	12 / 15	15	1/2"	4,6	3,3
63559	8710664	15	18	1/2"	4,6	3,3
63560	8710665	15 / 20	18	3/4"	4,8	3,3
63561	8710666	20 / 15	22	1/2"	4,6	3,3
63562	5052688	20	22	3/4"	4,9	3,4
63564	5052148	32 / 25	35	1"	6,3	4,6
63565	5052694	50	54	2"	8,5	6,2

Geberit Mapress Kobber albue 90° med utvendige gjenger (gass)

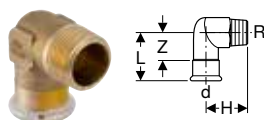

click & scan

Art. nr.	NRF nr.	DN	d, ø [mm]	R ["]	arc [°]	L [cm]	H [cm]	Z [cm]
34728	8710673	12 / 15	15	1/2"	90	3,5	3,1	1,5
34729	8710679	15	18	1/2"	90	3,5	3,4	1,5
34730	8710675	20	22	3/4"	90	3,8	3,7	1,7

Geberit Mapress Kobber albue 90° med innvendige gjenger (gass)

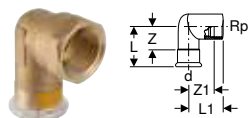

click & scan

Art. nr.	NRF nr.	DN	d, ø [mm]	Rp ["]	arc [°]	L [cm]	L1 [cm]	Z [cm]	Z1 [cm]
34725	8710683	12 / 15	15	1/2"	90	3,6	2,7	1,6	1,7
34726	8710689	15	18	1/2"	90	3,6	3	1,6	2
34727	8710685	20	22	3/4"	90	4,5	3,3	2,4	2,1

Overganger og forbindelser, løsbare

Geberit Mapress Kobber overgangsstykke med unionmutter (gass)



click & scan

Art. nr.	NRF nr.	DN	d, ø [mm]	G ["]	L [cm]	Z [cm]
34556	8710594	20	22	1 1/8"	3,7	1,6
34552	8710757	20	22	1 3/8"	4	1,9
34557	8710595	25	28	1 3/8"	4	1,7

Endedeksler

Geberit Mapress Kobber kappe (gass)

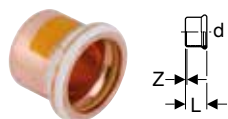

click & scan

Art. nr.	NRF nr.	DN	d, ø [mm]	L [cm]	Z [cm]
34752	8710749	12	15	2,3	0,3
34753	8710751	15	18	2,3	0,3
34754	8710752	20	22	2,5	0,4
34755	8710753	25	28	2,7	0,4
34756	8710754	32	35	3	0,4
34757	8710755	40	42	3,4	0,4
34758	8710756	50	54	3,9	0,4

Tilkoblinger

Geberit Mapress Kobber tilkopplingsbend 90° (gass)

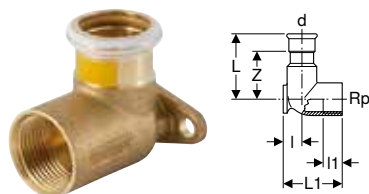

click & scan

Art. nr.	NRF nr.	DN	d, ø [mm]	Rp ["]	arc [°]	L [cm]	l [cm]	l1 [cm]	Z [cm]
L1 / Lengde: 4,3 cm									
34731	8710723	12	15	1/2"	90	3,2	1,3	2,2	1,2
34732	8710724	15	18	1/2"	90	3,2	1,3	2,2	1,2
L1 / Lengde: 5,1 cm									
34733	8710725	20	22	3/4"	90	3,5	1,7	2,2	1,4

Geberit Mapress Kobber tilkopplingsbend 90° forskjøvet, hullsirke 50 mm (gass)

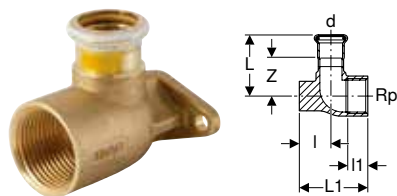

click & scan

Art. nr.	NRF nr.	DN	d, ø [mm]	Rp ["]	arc [°]	L [cm]	l [cm]	l1 [cm]	Z [cm]
L1 / Lengde: 6,5 cm									
91105	8710729	20 / 25	22	1"	90	4,2	3	2,2	2,1
91106	8710731	25	28	1"	90	4,4	3	2,2	2,1

Tilbehør for Geberit Mapress Kobber

Beskyttelse for rør og fittings

Geberit beskyttelsestape

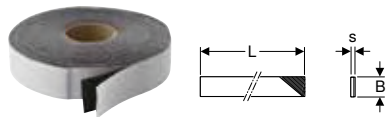

click & scan

Art. nr.	NRF nr.	s [mm]	L [m]	B [cm]
601.813.00.1	2472901	1	12,5	3
601.815.00.1	2472902	1	12,5	5



- Sett på etter trykkontroll

Klammer for rør

Geberit gjengestag

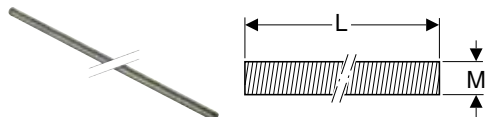

click & scan

Art. nr.	NRF nr.	Farge / overflate	M [mm]	L [cm]
362.834.26.1	2290088	El-forsinket	10	200

Geberit bunnplate rektangulær, to hull, med gjenget rørmuffe M8/M10

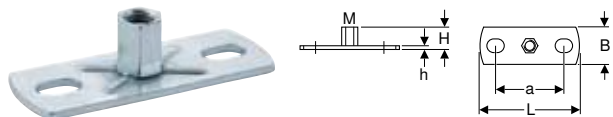

click & scan

Art. nr.	NRF nr.	M [mm]	a [cm]	L [cm]	B [cm]	H [cm]	h [cm]
362.848.26.1	2290373	8 / 10	5,4	8	3	1,9	0,3

Geberit bunnplate rektangulær, to hull, med gjenget rørmuffe M10 / G 1/2"



click & scan

Art. nr.	NRF nr.	G ["]	M [mm]	a [cm]	L [cm]	B [cm]	H [cm]	h [cm]
362.851.26.1	2290374	1/2"	10	8,5	12	4	1,5	0,5

Systempakninger

Geberit Mapress tetningsring CIIR svart



click & scan

Art. nr.	NRF nr.	DN	d, ø [mm]
90401	1952142	10	12
90402	1952144	12	15
90403	1952146	15	18
90404	1952148	20	22
90405	1952151	25	28
90406	1952153	32	35
90407	1952155	40	42
90408	1952157	50	54

Geberit Mapress tetningsring FKM blå



click & scan

Art. nr.	NRF nr.	DN	d, ø [mm]
90881	1952001	10	12
90882	1952003	12	15
90883	1952005	15	18
90884	1952007	20	22
90885	1952009	25	28
90886	1952012	32	35
90887	1952014	40	42
90888	1952016	50	54

Geberit Mapress planpakning EPDM svart

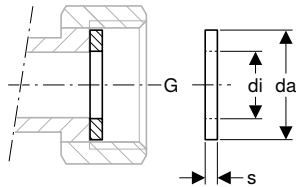

click & scan

Art. nr.	NRF nr.	G ["]	da [mm]	di, ø [mm]	s [mm]
90080	1952243	1/2"	18	10	2
90081	1952244	3/4"	24	13	2
90082	1952245	1"	30	19,6	2
90083	1952246	1 1/4"	39	25,6	2
90084	1952247	1 1/2"	45	32	2
90085	1952248	1 3/4"	50	39	2
90086	1952249	2 3/8"	66	51	3
90088		3"	84,7	76	3
90089		3 1/2"	97	84	3

Geberit Mapress planpakning FPM grønn

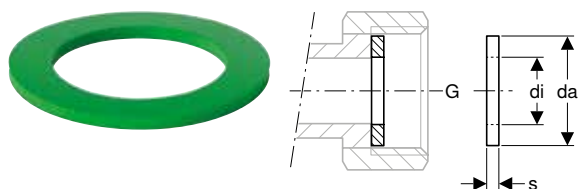

click & scan

Art. nr.	NRF nr.	G ["]	da [mm]	di, ø [mm]	s [mm]
90092	1952225	3/4"	24	13	2
90094	1952227	1"	30	19,6	2
90095	1952228	1 1/4"	39	25,6	2
90096	1952229	1 1/2"	45	32	2
90097	1952231	1 3/4"	50	39	2
90098	1952232	2 3/8"	66	51	2

Ny

Geberit Mapress planpakning fiberkomposittmateriale



click & scan

Art. nr.	G ["]	da [mm]	di, ø [mm]	s [mm]
600.079.00.1	1/2"	18,4	10	2
600.080.00.1	3/4"	23,9	13	2
600.081.00.1	1"	30	19,6	2
600.082.00.1	1 1/8"	34,7	21	2
600.083.00.1	1 1/4"	38	25	2
600.084.00.1	1 1/4"	38,7	25,6	2
600.085.00.1	1 1/2"	44,6	32	2
600.087.00.1	1 3/4"	50,5	39	2
600.088.00.1	2"	56,4	42	2
600.089.00.1	2 1/4"	62,5	42	2
600.090.00.1	2 3/8"	66,2	51	2
600.091.00.1	2 1/2"	72	54	2
600.092.00.1	2 3/4"	78,3	57	2
600.093.00.1	3"	84,7	72,1	2
600.094.00.1	3 1/2"	97,1	84,9	2

Kan leveres fra april 2024



- Erstatning for art. nr. 600.021.00.1, 600.022.00.1, 90072, 600.023.00.1, 90074, 600.024.00.1, 90075, 600.025.00.1, 600.026.00.1, 90076, 600.027.00.1, 90077, 600.028.00.1, 600.029.00.1, 600.030.00.1, 90078, 600.031.00.1, 600.032.00.1, 600.033.00.1, 600.034.00.1





Geberit Mapress CuNiFe



Målendringer Geberit Mapress CuNiFe april 2023 til april 2024.....	106
Bruksoversikt – Geberit Mapress CuNiFe	107
Geberit Mapress CuNiFe.....	108
Systemrør 2.1972	108
Muffer.....	108
Reduksjoner.....	109
Bend	110
T-rør	112
Overganger uløselige	114
Overganger og forbindelser, løsbare	115
Gjennomføringer	117
Tilbehør for Geberit Mapress CuNiFe.....	117
Systempakninger	117

Bruksoversikt – Geberit Mapress CuNiFe

Geberit Norge, Versjon: oktober 2023

Bruksformål	Driftstemperatur	Maximum operating pressure	Rør	Fittings	Tetningsringer	
			CuNiFe	Geberit Mapress CuNiFe svart indikator	CIIR svart	FKM blå
Flytende medier						
Til avkjøling og oppvarming av vann uten frostvæske	0–100 °C	13 bar/1300 kPa	✓	✓	✓	
Til avkjøling og oppvarming av vann med frostvæske	-30 – +120 °C	13 bar/1300 kPa	✓	✓	✓ ⁴⁾	
For industri- og prosessvann	0–100 °C	13 bar/1300 kPa	3)	3)	3)	
For forbruks- og svartvann med pH-verdi > 6,0	0–100 °C	13 bar/1300 kPa	✓	✓	✓	
For sjøvann	0–100 °C	13 bar/1300 kPa	✓	✓	✓	
For slukningsvann (vått)	0–70 °C	13 bar/1300 kPa	✓	✓	✓	
For sprinkler (våt)	0–70 °C	13 bar/1300 kPa	✓	✓	✓	
For mineral- og smøreolje	Ved forespørsel	Ved forespørsel	3)	3)		3)
For drivstoff (f.eks. diesel)	Ved forespørsel	Ved forespørsel	3)	3)		3)
Gassmedier						
For trykkluft (oljerenhetsklasse 0–3) ¹⁾	0–100 °C	10 bar /1000 kPa	✓	✓	✓	
For trykkluft (oljerenhetsklasse 0–X) ¹⁾	0–100 °C	10 bar /1000 kPa	✓	✓		✓
For undertrykk ²⁾	0–40 °C	Abs. ≥ 0,2 bar/20 kPa	✓	✓	✓	
For inertgasser (f.eks. nitrogen)	Ved forespørsel	Ved forespørsel	3)	3)	3)	

✓ Bruk er generelt godkjent når de definerte tilleggskravene iht. fotnotene er oppfylt

¹⁾ Oljerenhetsklasse iht. ISO 8573-1:2010E; for detaljer om fuktighet og partikler, se teknisk informasjon "Geberit rørledningssystemer for trykkluftinstallasjoner"

²⁾ Utnyttbart undertrykk for Geberit rørledningssystemer:

Utnyttbart undertrykk fremgår av lufttrykket på installasjonsstedet minus absoluttrykket fra 200 mbar.

Eksempel: 980 mbar lufttrykk – 200 mbar absoluttrykk = 780 mbar utnyttbart undertrykk i rørledningssystemet

³⁾ Etter godkjenning fra Geberit

⁴⁾ Bruk bare godkjente frostvæsker



- For hver bruk må driftsbetingelsene i de retningsgivende tillatelsene, normene og tekniske regelverkene overholdes. Disse kan avvike fra angivelsene ovenfor.

Målendringer Geberit Mapress CuNiFe april 2023 til april 2024

Geberit Norge, Versjon: oktober 2023

		[°]	DN	d, ø	L	L1	H
Geberit Mapress CuNiFe bend 90° med innvendige gjenger	67506	90 °	20	22 mm		8.4 cm	
	67507	90 °	20	22 mm		8.6 cm	
Geberit Mapress CuNiFe bend 90° med utvendige gjenger	67516	90 °	20	22 mm			8.2 cm
	67517	90 °	20	22 mm			8.6 cm



- Mellom april 2023 og april 2024 kommer artiklene som er oppført over, til å få nye mål iht. tabell. Artikler som har nye mål, blir merket med en ekstra X på etiketten

	Planpakninger for skrueforbindelser			Flenspakninger
	EPDM svart	FPM grøn	Fiberkomposittmateriale	Fiberkomposittmateriale
	✓		✓	✓
			✓	✓
	3)		3)	3)
	✓		✓	✓
	✓		✓	✓
	✓		✓	✓
	✓		✓	✓
		3)	3)	3)
		3)	3)	3)
			✓	✓
		✓	✓	✓
	✓		✓	✓
	3)		3)	3)



Geberit Mapress CuNiFe

Systemrør 2.1972

Geberit Mapress CuNiFe systemrør

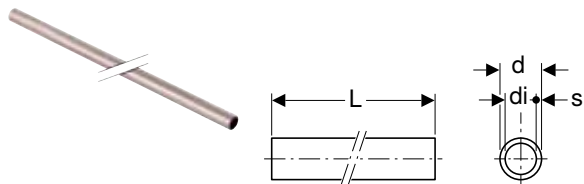

click & scan

Art. nr.	NRF nr.	DN	d, ø [mm]	di, ø [mm]	s [mm]	L [m]
56319	5053706	12	15	13	1	6
56326	5053711	20	22	19	1,5	6
56322	5053713	25	28	25	1,5	6
56323	5053715	32	35	32	1,5	6
56324	5053717	40	42	39	1,5	6
56325	5053719	50	54	51	1,5	6
56327	5053722	65	76,1	72,1	2	6
56328	5053724	80	88,9	84,9	2	6
56329	5053726	100	108	104	2,5	6

Tilbehør

- Geberit Mapress rørkutter R → s. 291
- Geberit Mapress avgrader → s. 292
- Geberit Mapress merkemal med merkepenn → s. 292

Muffer

Geberit Mapress CuNiFe muffer



click & scan

Art. nr.	NRF nr.	DN	d, ø [mm]	L [cm]	Z [cm]
67002	5054246	12	15	4,8	0,8
67004	5054251	20	22	5	0,8
67005	5054253	25	28	5,4	0,8
67006	5054255	32	35	6,2	1
67007	5054257	40	42	7,1	1,1
67008	5054259	50	54	8,3	1,3
67009	5054262	65	76,1	12,7	2,1
67010	5054264	80	88,9	14,5	2,5
67011	5054266	100	108	17,6	2,6

Geberit Mapress CuNiFe glidemuffe

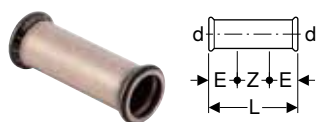

click & scan

Art. nr.	NRF nr.	DN	d, ø [mm]	E [cm]	L [cm]	Z [cm]
67102	5054286	12	15	2,5	8	3
67104	5054291	20	22	2,5	8,4	3,4
67105	5054293	25	28	3	9,1	3,1
67106	5054295	32	35	3	10,2	4,2
67107	5054297	40	42	4	12	4
67108	5054299	50	54	4	14	6
67109	5054302	65	76,1	6	23	11
67110	5054304	80	88,9	7	26	12
67111	5054306	100	108	8	31	15

Reduksjoner

Geberit Mapress CuNiFe reduksjon med spissende

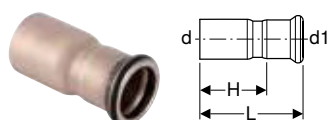

click & scan

Art. nr.	NRF nr.	DN	d, ø [mm]	d1, ø [mm]	L [cm]	H [cm]
67305	5054182	20 / 12	22	15	5,9	3,9
67307	5054186	25 / 12	28	15	6,6	4,6
67309	5054191	25 / 20	28	22	6	3,9
67312	5054193	32 / 20	35	22	7,1	5
67313	5054195	32 / 25	35	28	6,8	4,5
67317	5054199	40 / 25	42	28	8,3	6
67318	5054202	40 / 32	42	35	7,6	5
67323	5054206	50 / 32	54	35	10,6	8
67324	5054208	50 / 40	54	42	8,9	5,9
67337	5054211	65 / 40	76,1	42	12,7	9,7
67325	5054213	65 / 50	76,1	54	14,6	11,1
67338	5054215	80 / 50	88,9	54	16,2	12,8
67327	5054217	80 / 65	88,9	76,1	16	10,7
67346	5054222	100 / 65	108	76,1	18,4	13,1
67330	5054224	100 / 80	108	88,9	20,4	14,4

Bend

Geberit Mapress CuNiFe bend

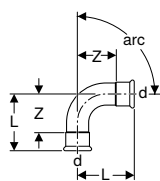

Art. nr.	NRF nr.	DN	d, ø [mm]	L [cm]	Z [cm]
arc / Vinkel: 15°					
68716	5017839	12	15	3	1
68718	5017841	20	22	3,3	1,2
68719	5017842	25	28	3,6	1,3
68720	5017843	32	35	3,2	0,6
68721	5017844	40	42	3,7	0,7
68722	5017845	50	54	4,4	0,9
68723	5017846	65	76,1	7,5	2,2
68724	5017847	80	88,9	8,5	2,5
68725	5017848	100	108	10,3	2,8
arc / Vinkel: 30°					
68736	5017859	12	15	3,3	1,3
68738	5017861	20	22	3,7	1,6
68739	5017862	25	28	4,1	1,8
68740	5017863	32	35	3,7	1,1
68741	5017864	40	42	4,4	1,4
68742	5017865	50	54	5,2	1,7
68743	5017866	65	76,1	8,8	3,5
68744	5017867	80	88,9	10,1	4,1
68745	5017868	100	108	12,2	4,7
arc / Vinkel: 45°					
67602	5054462	12	15	2,8	0,8
67604	5054466	20	22	3,2	1,1
67605	5054468	25	28	3,7	1,4
67606	5054471	32	35	4,3	1,7
67607	5054473	40	42	5,1	2,1
67608	5054475	50	54	6,2	2,7
67609	5054477	65	76,1	10,3	5
67610	5054479	80	88,9	11,7	5,7
67611	5054482	100	108	14,3	6,8
arc / Vinkel: 60°					
68804	5017879	12	15	4	2
68806	5017881	20	22	4,7	2,6
68807	5017882	25	28	5,4	3,1
68808	5017883	32	35	5	2,4
68809	5017884	40	42	5,9	2,9
68810	5017885	50	54	7,2	3,7
68811	5017886	65	76,1	11,7	6,4
68812	5017887	80	88,9	13,6	7,6
68813	5017888	100	108	16,6	9,1
arc / Vinkel: 90°					
68102	5053806	12	15	2,8	0,8
68104	5053811	20	22	3,2	1,1
68105	5053813	25	28	5,7	3,4
68106	5053815	32	35	6,8	1,7
68107	5053817	40	42	8	2,1
68108	5053819	50	54	6,2	2,7
68109	5053822	65	76,1	15,9	10,6
68110	5053824	80	88,9	18,5	12,5
68111	5053826	100	108	23	15,5

Geberit Mapress CuNiFe bend med spissende

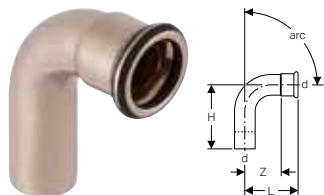

click & scan

Art. nr.	NRF nr.	DN	d, ø [mm]	L [cm]	H [cm]	Z [cm]
arc / Vinkel: 15°						
68726	5017849	12	15	3	4	1
68728	5017851	20	22	3,3	4,1	1,2
68729	5017852	25	28	3,6	4,3	1,3
68730	5017853	32	35	3,2	4,1	0,6
68731	5017854	40	42	3,7	4,7	0,7
68732	5017855	50	54	4,4	5,5	0,9
68733	5017856	65	76,1	7,5	8,4	2,2
68734	5017857	80	88,9	8,5	9,5	2,5
68735	5017858	100	108	10,3	11,7	2,8
arc / Vinkel: 30°						
68746	5017869	12	15	3,3	4,3	1,3
68748	5017871	20	22	3,7	4,6	1,6
68749	5017872	25	28	4,1	4,8	1,8
68750	5017873	32	35	3,7	4,6	1,1
68751	5017874	40	42	4,4	5,4	1,4
68752	5017875	50	54	5,2	6,3	1,7
68753	5017876	65	76,1	8,8	9,7	3,5
68754	5017877	80	88,9	10,1	11,1	4,1
68755	5017878	100	108	12,2	13,6	4,7
arc / Vinkel: 45°						
67702	5054532	12	15	2,8	3,8	0,8
67704	5054536	20	22	3,2	4,4	1,1
67705	5054538	25	28	3,7	4,6	1,4
67706	5054541	32	35	5,3	4,3	1,7
67707	5054543	40	42	5,1	5,9	2,1
67708	5054545	50	54	6,2	7	2,7
67709	5054547	65	76,1	10,3	11,1	5
67710	5054549	80	88,9	11,7	12,8	5,7
67711	5054552	100	108	14,3	15,8	6,8
arc / Vinkel: 60°						
68814	5017889	12	15	4	5	2
68816	5017891	20	22	4,7	5,6	2,6
68817	5017892	25	28	5,4	6,1	3,1
68818	5017893	32	35	5	5,9	2,4
68819	5017894	40	42	5,9	6,9	2,9
68820	5017895	50	54	7,2	8,3	3,7
68821	5017896	65	76,1	11,7	12,6	6,4
68822	5017897	80	88,9	13,6	14,6	7,6
68823	5017898	100	108	16,6	18	9,1
arc / Vinkel: 90°						
68302	5053846	12	15	2,8	3,6	0,8
68304	5053851	20	22	3,2	3,9	1,1
68305	5053853	25	28	5,7	6,6	3,4
68306	5053855	32	35	6,8	7,7	4,2
68307	5053857	40	42	8	8,8	5
68308	5053859	50	54	6,2	7	2,7
68309	5053862	65	76,1	15,9	16,7	10,6
68310	5053864	80	88,9	18,5	19,5	12,5
68311	5053866	100	108	23	24,1	15,5

Geberit Mapress CuNiFe passbend 90°

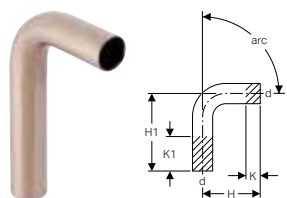

click & scan

Art. nr.	NRF nr.	DN	d, ø [mm]	arc [°]	H [cm]	H1 [cm]	K1 maks. [cm]
67402	5017919	12	15	90	5,9	12,9	7
67404	5017921	20	22	90	7	14,2	7,2
67405	5017922	25	28	90	7,9	15,5	7,6
67406	5017923	32	35	90	7,7	15,4	7,7
67407	5017924	40	42	90	9	18	9
67408	5017925	50	54	90	11,1	20,5	9,4

T-rør

Geberit Mapress CuNiFe T-rør likt

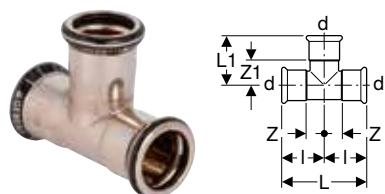

click & scan

Art. nr.	NRF nr.	DN	d, ø [mm]	arc [°]	L [cm]	L1 [cm]	l [cm]	Z [cm]	Z1 [cm]
68002	5053956	12	15	90	6,4	4	3,2	1,2	2
68004	5053961	20	22	90	7,4	4,5	3,7	1,6	2,4
68005	5053963	25	28	90	8,4	5,1	4,2	1,9	2,8
68006	5053965	32	35	90	10	5,9	5	2,4	3,3
68007	5053967	40	42	90	11,4	6,6	5,7	2,7	3,6
68008	5053969	50	54	90	13,8	7,2	6,9	3,4	3,7
68009	5053972	65	76,1	90	23	11	11,5	6,2	5,7
68010	5053974	80	88,9	90	26	12,7	13	7	6,7
68011	5053976	100	108	90	31	15,3	15,5	8	7,8

Geberit Mapress CuNiFe T-rør redusert

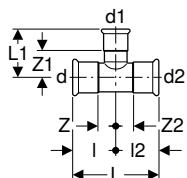

click & scan

Art. nr.	NRF nr.	DN	d, ø [mm]	d1, ø [mm]	d2, ø [mm]	arc [°]	L [cm]	L1 [cm]	I [cm]	I2 [cm]	Z [cm]	Z1 [cm]	Z2 [cm]
67206	5054003	20 / 12 / 20	22	15	22	90	7,4	4,4	3,7	3,7	1,6	2,4	1,6
67209	5054008	25 / 12 / 25	28	15	28	90	8,4	4,7	4,2	4,2	1,9	2,7	1,9
67211	5054013	25 / 20 / 25	28	22	28	90	8,4	4,8	4,2	4,2	1,9	2,7	1,9
67212	5054015	32 / 12 / 32	35	15	35	90	10	4,9	5	5	2,4	2,9	2,4
67214	5054019	32 / 20 / 32	35	22	35	90	10	5,2	5	5	2,4	2,1	2,4
67215	5054022	32 / 25 / 32	35	28	35	90	10	5,5	5	5	2,4	3,2	2,4
67218	5054024	40 / 20 / 40	42	22	42	90	11,4	5,4	5,7	5,7	2,7	3,3	2,7
67219	5054026	40 / 25 / 40	42	28	42	90	11,4	5,8	5,7	5,7	2,7	3,5	2,7
67220	5054028	40 / 32 / 40	42	35	42	90	11,4	6,2	5,7	5,7	2,7	3,6	2,7
67227	5054031	50 / 20 / 50	54	22	54	90	13,8	6,1	6,9	6,9	3,4	4	3,4
67228	5054033	50 / 25 / 50	54	28	54	90	13,8	6,4	6,9	6,9	3,4	4,1	3,4
67225	5054035	50 / 32 / 50	54	35	54	90	13,8	6,8	6,9	6,9	3,4	4,2	3,4
67226	5054037	50 / 40 / 50	54	42	54	90	13,8	7,2	6,9	6,9	3,4	4,2	3,4
67229	5054039	65 / 20 / 65	76,1	22	76,1	90	23	7,2	11,5	11,5	6,2	5,1	6,2
67230	5054042	65 / 25 / 65	76,1	28	76,1	90	23	7,5	11,5	11,5	6,2	5,2	6,2
67231	5054044	65 / 32 / 65	76,1	35	76,1	90	23	7,9	11,5	11,5	6,2	5,3	6,2
67252	5054046	65 / 40 / 65	76,1	42	76,1	90	23	8,3	11,5	11,5	6,2	5,3	6,2
67253	5054048	65 / 50 / 65	76,1	54	76,1	90	23	8,9	11,5	11,5	6,2	5,4	6,2
67233	5054051	80 / 20 / 80	88,9	22	88,9	90	26	7,8	13	13	7	5,7	7
67250	5054053	80 / 25 / 80	88,9	28	88,9	90	26	8,1	13	13	7	5,8	7
67251	5054055	80 / 32 / 80	88,9	35	88,9	90	26	8,5	13	13	7	5,9	7
67239	5054057	80 / 40 / 80	88,9	42	88,9	90	26	8,9	13	13	7	5,9	7
67260	5054059	80 / 50 / 80	88,9	54	88,9	90	26	9,5	13	13	7	6	7
67261	5054062	80 / 65 / 80	88,9	76,1	88,9	90	26	11,6	13	13	7	6,3	7
67244	5054064	100 / 20 / 100	108	22	108	90	31	8,8	15,5	15,5	8	6,7	8
67245	5054066	100 / 25 / 100	108	28	108	90	31	9,1	15,5	15,5	8	6,8	8
67246	5054068	100 / 32 / 100	108	35	108	90	31	9,5	15,5	15,5	8	6,9	8
67247	5054071	100 / 40 / 100	108	42	108	90	31	9,9	15,5	15,5	8	6,9	8
67248	5054073	100 / 50 / 100	108	54	108	90	31	10,5	15,5	15,5	8	7	8
67269	5054075	100 / 65 / 100	108	76,1	108	90	31	12,6	15,5	15,5	8	7,3	8
67270	5054077	100 / 80 / 100	108	88,9	108	90	31	13,7	15,5	15,5	8	7,7	8

Geberit Mapress CuNiFe T-rør med innvendige gjenger

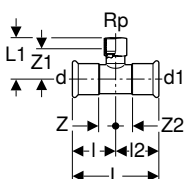

click & scan

Art. nr.	NRF nr.	DN	d, ø [mm]	Rp ["]	d1, ø [mm]	arc [°]	L [cm]	L1 [cm]	I [cm]	I2 [cm]	Z [cm]	Z1 [cm]	Z2 [cm]
67344	5054106	12 / 15 / 12	15	1/2"	15	90	6,4	3,7	3,2	3,2	0,8	2,4	0,8
67347	5054113	20 / 15 / 20	22	1/2"	22	90	7,4	4,1	3,7	3,7	1,6	2,8	1,6
67348	5054115	20	22	3/4"	22	90	7,4	4,6	3,7	3,7	1,6	3,1	1,6
67349	5054117	25 / 15 / 25	28	1/2"	28	90	8,4	4,4	4,2	4,2	1,9	3,1	1,9
67350	5054119	25 / 20 / 25	28	3/4"	28	90	8,4	4,6	4,2	4,2	1,9	3,1	1,9
67352	5054122	32 / 15 / 32	35	1/2"	35	90	10	4,8	5	5	2,4	3,5	2,4
67353	5054124	32 / 20 / 32	35	3/4"	35	90	10	5,3	5	5	2,4	4	2,4
67356	5054126	40 / 15 / 40	42	1/2"	42	90	11,4	5,1	5,7	5,7	2,7	3,8	2,7
67357	5054128	40 / 20 / 40	42	3/4"	42	90	11,4	5,6	5,7	5,7	2,7	4,3	2,7
67360	5054131	50 / 15 / 50	54	1/2"	54	90	13,8	5,7	6,9	6,9	3,4	4,4	3,4
67361	5054133	50 / 20 / 50	54	3/4"	54	90	13,8	6,2	6,9	6,9	3,4	4,9	3,4
67366	5054137	65 / 20 / 65	76,1	3/4"	76,1	90	23	7	11,5	11,5	6,2	5,5	6,2
67369	5054139	80 / 20 / 80	88,9	3/4"	88,9	90	26	7,6	13	13	7	6,1	7
67373	5054142	100 / 20 / 100	108	3/4"	108	90	31	8,6	15,5	15,5	8	7,1	8

Overganger uløselige

Geberit Mapress CuNiFe overgangsstykke med utvendige gjenger



click & scan

Art. nr.	NRF nr.	DN	d, ø [mm]	R ["]	L [cm]	H [cm]
68703	5054329	12 / 15	15	1/2"	5,3	3,3
68715	5017912	20 / 15	22	1/2"	5,4	3,3
68707	5054339	20	22	3/4"	5,8	3,7
68708	5054344	25	28	1"	6,4	4,1
68709	5054351	32	35	1 1/4"	7,2	4,6
68710	5054355	40	42	1 1/2"	7,7	4,7
68711	5054357	50	54	2"	8,9	5,4



- Overganger med NPT-gjenger på forespørsel

Geberit Mapress CuNiFe overgangsstykke med utvendige gjenger NPT



click & scan

Art. nr.	NRF nr.	DN	d, ø [mm]	NPT	L [cm]	H [cm]
68833	5017913	12 / 15	15	1/2"	6,1	4,1
68837	5017914	20	22	3/4"	6,3	4,2
68838	5017915	25	28	1"	7,2	4,9
68839	5017916	32	35	1 1/4"	7,8	5,2
68840	5017917	40	42	1 1/2"	8,3	5,3
68841	5017918	50	54	2"	9	5,5

Geberit Mapress CuNiFe overgangsstykke med innvendige gjenger



click & scan

Art. nr.	NRF nr.	DN	d, ø [mm]	Rp ["]	L [cm]	Z [cm]
67802	5054383	12 / 15	15	1/2"	5,5	2,2
67805	5054389	20 / 15	22	1/2"	5,6	2,2
67806	5054392	20	22	3/4"	5,8	2,2
67809	5054398	25	28	1"	6,4	2,4
67811	5054406	32	35	1 1/4"	7	2,5
67814	5054409	40	42	1 1/2"	7,4	2,5
67818	5054412	50	54	2"	8,9	3,1

Geberit Mapress CuNiFe albue 90° med utvendige gjenger

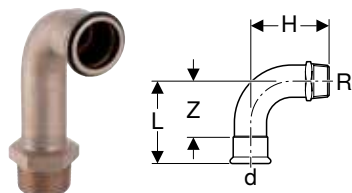

click & scan

Art. nr.	NRF nr.	DN	d, ø [mm]	R ["]	arc [°]	L [cm]	H [cm]	Z [cm]
67515	5054439	12 / 15	15	1/2"	90	3,8	7,5	1,8
67516	5017903	20 / 15	22	1/2"	90	4,7	8,4	2,6
67517	5054444	20	22	3/4"	90	4,7	8,8	2,6
67518	5054446	25	28	1"	90	5,7	9,7	3,4
67519	5054448	32	35	1 1/4"	90	6,8	11,2	4,2
67520	5054451	40	42	1 1/2"	90	8	12,4	5
67521	5054453	50	54	2"	90	10	14,9	6,5

Geberit Mapress CuNiFe albue 90° med innvendige gjenger

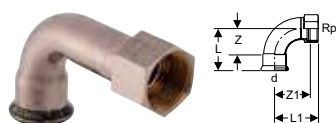

click & scan

Art. nr.	NRF nr.	DN	d, ø [mm]	Rp ["]	arc [°]	L [cm]	L1 [cm]	Z [cm]	Z1 [cm]
67503	5054509	12 / 15	15	1/2"	90	3,8	7,7	1,8	6,4
67506	5017899	20 / 15	22	1/2"	90	4,7	8,6	2,6	7,3
67507	5054516	20	22	3/4"	90	4,7	8,8	2,6	7,3
67508	5054521	25	28	1"	90	5,7	9,7	4	7,8
67509	5054523	32	35	1 1/4"	90	6,8	11	4,2	9,1
67510	5017901	40	42	1 1/2"	90	8	12,1	5	10,4
67511	5017902	50	54	2"	90	10	15	6,5	13

Overganger og forbindelser, løsbare

Geberit Mapress CuNiFe union med utvendige gjenger



click & scan

Art. nr.	NRF nr.	DN	d, ø [mm]	R ["]	G ["]	L [cm]	H [cm]
67232	5054635	12 / 15	15	1/2"	3/4"	8,1	6,1
67234	5054636	20 / 15	22	1/2"	1"	8,4	6,3
67243	5054637	20	22	3/4"	1"	8,5	6,4
67235	5054638	25	28	1"	1 1/4"	9,6	7,3
67236	5054639	32	35	1 1/4"	1 1/2"	10,4	7,8
67237	5054641	40	42	1 1/2"	1 3/4"	10,9	7,9
67238	5054642	50	54	2"	2 3/8"	12,4	8,9

Geberit Mapress CuNiFe flens PN 6, med muffe

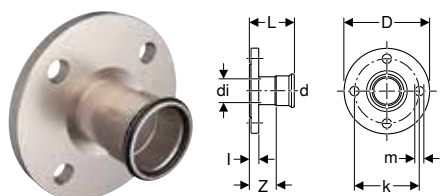

click & scan

Art. nr.	DN	d, ø [mm]	di, ø [mm]	D [cm]	k [mm]	m [mm]	L [cm]	l [cm]	Z [cm]	n [pc.]	PN [bar]
68682	15 / 12	15	14,1	8	55	11	5,9	1	3,9	4	6
68684	20	22	19	9	65	11	6,3	1	4,2	4	6
68685	25	28	25,2	10	75	11	6,7	1	4,4	4	6
68686	32	35	32	12	90	14	6,8	1	4,2	4	6
68687	40	42	39	13	100	14	7,7	1,2	4,7	4	6
68688	50	54	51	14	110	14	8,5	1,4	5	4	6
68689	65	76,1	71,9	16	130	14	11,8	1,6	6,5	4	6
68690	80	88,9	84,7	19	150	18	12,3	1,6	6,3	4	6
68691	100	108	103,8	21	170	18	12,8	1,8	5,3	4	6

Geberit Mapress CuNiFe flens PN 10/16, med muffe

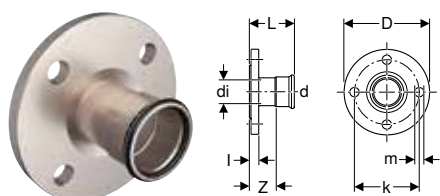

click & scan

Art. nr.	NRF nr.	DN	d, ø [mm]	di, ø [mm]	D [cm]	k [mm]	m [mm]	L [cm]	l [cm]	Z [cm]	n [pc.]	PN [bar]
68692	5017904	15 / 12	15	14,1	9,5	65	14	6,1	1,2	4,1	4	10 / 16
68694	5017831	20	22	19	10,5	75	14	6,5	1,2	4,4	4	10 / 16
68695	5017832	25	28	25,2	11,5	85	14	6,9	1,2	4,6	4	10 / 16
68696	5017833	32	35	32	14	100	18	7,2	1,4	4,6	4	10 / 16
68697	5017834	40	42	39	15	110	18	7,9	1,4	4,9	4	10 / 16
68698	5017835	50	54	51	16,5	125	18	8,7	1,6	5,2	4	10 / 16
68699	5017836	65	76,1	71,9	18,5	145	18	11,8	1,6	6,5	4	10 / 16
68700	5017837	80	88,9	84,7	20	160	18	12,5	1,8	6,5	8	10 / 16
68701	5017838	100	108	103,8	22	180	18	13	2	5,5	8	10 / 16

Geberit Mapress CuNiFe spissende for løsfrens PN 6

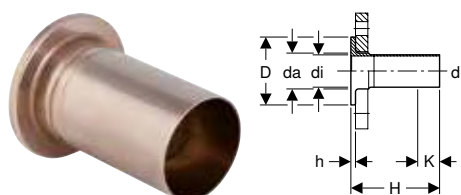

click & scan

Art. nr.	NRF nr.	DN	d, ø [mm]	da [mm]	di, ø [mm]	D [cm]	H [cm]	h [cm]	K [cm]	PN [bar]
68756	5017926	20	22	27	19	5	13,5	0,6	3,9	6
68757	5017927	25	28	32	25	6	13,5	0,6	3,7	6
68758	5017928	32	35	40	32	7	13,5	0,6	2,7	6
68759	5017929	40	42	47	39	8	13,5	0,6	0	6
68760	5017931	50	54	59	51	9	13,5	0,8	0	6
68761	5017932	65	76,1	78	72,1	11	13,5	0,8	0	6
68762	5017933	80	88,9	91	84,9	12,8	13,5	1	0	6
68763	5017934	100	108	110	104	14,8	13,5	1	0	6

Bestilles i tillegg

- Løsfrens

Geberit Mapress CuNiFe spissende for løsfleus PN 10/16

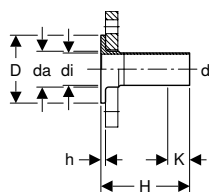

click & scan

Art. nr.	NRF nr.	DN	d, ø [mm]	da [mm]	di, ø [mm]	D [cm]	H [cm]	h [cm]	K [cm]	PN [bar]
68791	5054706	20	22	27	19	5,8	13,5	0,6	3,5	10 / 16
68793	5054708	25	28	32	25	6,8	13,5	0,6	3,7	10 / 16
68794	5054711	32	35	40	32	7,8	13,5	0,6	2,5	10 / 16
68795	5054713	40	42	47	39	8,8	13,5	0,6	0	10 / 16
68796	5054715	50	54	59	51	10,2	13,5	0,8	0	10 / 16
68797	5054717	65	76,1	78	72,1	12,2	13,5	0,8	0	10 / 16
68798	5054719	80	88,9	91	84,9	13,8	13,5	1	0	10 / 16
68799	5054722	100	108	110	104	15,8	13,5	1	0	10 / 16

Bestilles i tillegg

- Løsfleus

Gjennomføringer

Geberit Mapress CuNiFe skott- og takgjennomføring med to spissender

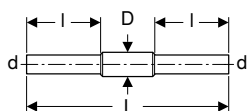

click & scan

Art. nr.	NRF nr.	DN	d, ø [mm]	D [cm]	L [cm]	l [cm]
92080	5054736	12	15	2,5	45	16,5
92082	5054741	20	22	3,4	45	16,5
92083	5054743	25	28	3,8	45	16,5
92084	5054745	32	35	4,5	45	16,5
92085	5054747	40	42	5,4	45	16,5
92086	5054749	50	54	7	45	16,5
92087	5054752	65	76,1	8,9	45	16,5
92088	5054754	80	88,9	10,8	45	16,5
92089	5054756	100	108	13,3	45	16,5

Tilbehør for Geberit Mapress CuNiFe

Systempakninger

Geberit Mapress tetningsring CIIR svart



click & scan

Art. nr.	NRF nr.	DN	d, ø [mm]
90401	1952142	10	12
90402	1952144	12	15
90403	1952146	15	18
90404	1952148	20	22
90405	1952151	25	28
90406	1952153	32	35
90407	1952155	40	42
90408	1952157	50	54
90409	1952159	65	76,1
90410	1952162	80	88,9
90411	1952164	100	108

Geberit Mapress tetningsring FKM blå



click & scan

Art. nr.	NRF nr.	DN	d, ø [mm]
90881	1952001	10	12
90882	1952003	12	15
90883	1952005	15	18
90884	1952007	20	22
90885	1952009	25	28
90886	1952012	32	35
90887	1952014	40	42
90888	1952016	50	54
90891	1952018	65	76,1
90892	1952021	80	88,9
90893	1952023	100	108

Geberit Mapress planpakning EPDM svart

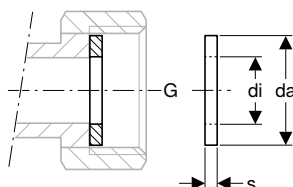

click & scan

Art. nr.	NRF nr.	G ["]	da [mm]	di, ø [mm]	s [mm]
90080	1952243	1/2"	18	10	2
90081	1952244	3/4"	24	13	2
90082	1952245	1"	30	19,6	2
90083	1952246	1 1/4"	39	25,6	2
90084	1952247	1 1/2"	45	32	2
90085	1952248	1 3/4"	50	39	2
90086	1952249	2 3/8"	66	51	3
90088		3"	84,7	76	3
90089		3 1/2"	97	84	3

Geberit Mapress planpakning FPM grønn

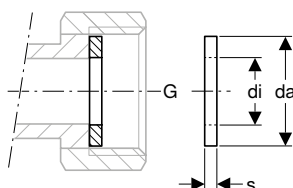

click & scan

Art. nr.	NRF nr.	G ["]	da [mm]	di, ø [mm]	s [mm]
90092	1952225	3/4"	24	13	2
90094	1952227	1"	30	19,6	2
90095	1952228	1 1/4"	39	25,6	2
90096	1952229	1 1/2"	45	32	2
90097	1952231	1 3/4"	50	39	2
90098	1952232	2 3/8"	66	51	2

Ny

Geberit Mapress planpakning fiberkomposittmateriale



click & scan

Art. nr.	G ["]	da [mm]	di, ø [mm]	s [mm]
600.079.00.1	1/2"	18,4	10	2
600.080.00.1	3/4"	23,9	13	2
600.081.00.1	1"	30	19,6	2
600.082.00.1	1 1/8"	34,7	21	2
600.083.00.1	1 1/4"	38	25	2
600.084.00.1	1 1/4"	38,7	25,6	2
600.085.00.1	1 1/2"	44,6	32	2
600.087.00.1	1 3/4"	50,5	39	2
600.088.00.1	2"	56,4	42	2
600.089.00.1	2 1/4"	62,5	42	2
600.090.00.1	2 3/8"	66,2	51	2
600.091.00.1	2 1/2"	72	54	2
600.092.00.1	2 3/4"	78,3	57	2
600.093.00.1	3"	84,7	72,1	2
600.094.00.1	3 1/2"	97,1	84,9	2

Kan leveres fra april 2024



- Erstatning for art. nr. 600.021.00.1, 600.022.00.1, 90072, 600.023.00.1, 90074, 600.024.00.1, 90075, 600.025.00.1, 600.026.00.1, 90076, 600.027.00.1, 90077, 600.028.00.1, 600.029.00.1, 600.030.00.1, 90078, 600.031.00.1, 600.032.00.1, 600.033.00.1, 600.034.00.1



Geberit Mepla



Bruksoversikt – Geberit Mepla.....	123
Systemrør multilayer	124
Fittings	125
Koblinger.....	125
Reduksjoner.....	126
Albue	126
T-stykker.....	127
Innvendig sirkulasjon.....	128
Overganger uløselige	129
Overganger og forbindelser, løsbare	132
Endedekslar.....	134
Tilkoblinger	135
Fordeler med gjengestuss.....	135
Tilkoblinger for varme	136
Tilbehør	136
Beskyttelse for rør og fittings	136
Klammer for rør	137

Bruksoversikt – Geberit Mepla

Geberit Norge, Versjon: oktober 2023

Bruksformål	Driftstemperatur	Maximum operating pressure	Rør	
			Mepla multilayer	MeplaTherm multilayer, teknisk vann
Flytende medier				
For drikkevann kaldt og varmt	0–70 °C ³⁾	10 bar /1000 kPa	✓	
For kaldt drikkevann	0–20 °C	Maximum operating pressure	✓	
Til avkjøling og oppvarming av vann uten frostvæske	0–80 °C ⁴⁾	10 bar /1000 kPa	✓	✓
Til avkjøling og oppvarming av vann med frostvæske	-10–+40 °C ⁵⁾	10 bar /1000 kPa	✓	✓
For industri- og prosessvann	0–70 °C	10 bar /1000 kPa	6)	6)
Til behandlet vann ¹⁾	0–70 °C	10 bar /1000 kPa	✓ ⁷⁾	✓ ⁷⁾
For regnvann med pH-verdi > 6,0	0–70 °C	10 bar /1000 kPa	✓	✓
For sjøvann	0–70 °C	10 bar /1000 kPa	✓	✓
For kjemikalier og tekniske væsker	Ved forespørsel	Ved forespørsel	6)	6)
Gassmedier				
For trykkluft (renhetsklasse olje 0–3)	0–70 °C	10 bar /1000 kPa	✓	✓
For undertrykk ²⁾	0–70 °C	Abs. ≥ 0,2 bar/20 kPa	✓	✓

✓ Bruk er generelt godkjent når de definerte tilleggskravene iht. fotnotene er oppfylt

¹⁾ bruksområder i henhold til den tekniske informasjonen "Behandlet vann"

²⁾ Utnyttbart undertrykk for Geberit rørledningssystemer:

Utnyttbart undertrykk fremgår av lufttrykket på intallasjonsstedet minus absoluttrykket fra 200 mbar.

Eksempel: 980 mbar lufttrykk – 200 mbar absoluttrykk = 780 mbar utnyttbart undertrykk i rørledningssystemet

³⁾ Feiltemperatur iht. EN 806/-2: Tmal = 95 °C, totalt 100 h i løpet av levetiden

⁴⁾ Feiltemperatur iht. ISO 10508/2006: Tmal = 100 °C, totalt 100 h i løpet av levetiden

⁵⁾ Høyere temperaturer bare etter godkjenning fra Geberit

⁶⁾ Etter godkjenning fra Geberit

⁷⁾ Bruksområde i henhold til teknisk informasjon (TI) "Bearbeidet vann"

⁸⁾ pH-verdi ≥ 7,0 tillatt i forbindelse med messing

⁹⁾ Renhetsklasse olje iht. ISO 8573-1:2010E; du finner informasjon om fuktighet og partikler i teknisk informasjon "Geberit rørledningssystemer for trykkluftinstallasjoner"



- For hver bruk må driftsbetingelsene i de retningsgivende tillatelsene, normene og tekniske regelverkene overholdes. Disse kan avvike fra angivelsene ovenfor.

	Fittings				O-ringer	Planpakninger for skrueforbindelser	Flenspakninger
	Plast	Rødgods	Messing	Syrefast stål	EPDM svart	Fiberkomposittmateriale	Fiberkomposittmateriale
	✓	✓	✓		✓	✓	✓
	✓	✓	✓		✓	✓	✓
	✓	✓	✓	✓	✓	✓	✓
	✓	✓	✓	✓	✓	✓	✓
	6)	6)		6)	6)	6)	6)
	✓7)	✓7)		✓7)	✓7)	✓7)	✓7)
	✓	✓8)	✓8)	✓	✓	✓	✓
	✓				✓	✓	✓
	6)	6)	6)	6)	6)	6)	6)
	✓	✓	✓	✓	✓9)	✓	✓
	✓	✓	✓	✓	✓	✓	✓



Systemrør multilayer

Geberit Mepla systemrør multilayer, rette lengder

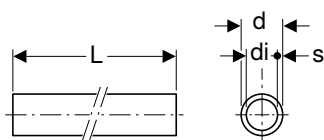
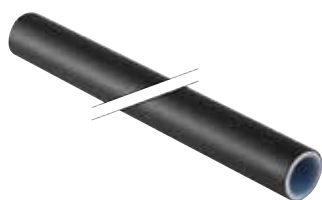

click & scan

Art. nr.	NRF nr.	DN	d, ø [mm]	di, ø [mm]	s [mm]
L / Lengde: 3 m					
601.100.00.2	2472001	12	16	11,5	2,25
602.100.00.2	2472002	15	20	15	2,5
603.100.00.2	2472017	20	26	20	3
604.100.00.2	2472019	25	32	26	3
605.100.00.2	2472021	32	40	33	3,5
606.100.00.2	2472913	40	50	42	4
607.100.00.2	2472914	50	63	54	4,5
L / Lengde: 5 m					
601.100.00.1	2472003	12	16	11,5	2,25
602.100.00.1	2472005	15	20	15	2,5
603.100.00.1	2472007	20	26	20	3
604.100.00.1	2472009	25	32	26	3
605.100.00.1	2472012	32	40	33	3,5
606.100.00.1	2472014	40	50	42	4
607.100.00.1	2472016	50	63	54	4,5
608.100.00.1	2472018	65	75	65,6	4,7

Tilbehør

- Geberit Mepla saks → s. 306
- Geberit rørkutter ML → s. 298
- Geberit Mepla avgrader og kalibreringsverktøy → s. 307

Geberit Mepla systemrør multilayer, kveil

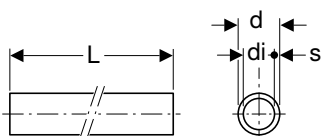

click & scan

Art. nr.	NRF nr.	DN	d, ø [mm]	di, ø [mm]	s [mm]	L [m]
601.130.00.1	2472043	12	16	11,5	2,25	50
601.130.00.2	2472915	12	16	11,5	2,25	100
602.130.00.1	2472045	15	20	15	2,5	50
602.130.00.2	2472917	15	20	15	2,5	100
603.110.00.1	2472026	20	26	20	3	50

Tilbehør

- Geberit Mepla saks → s. 306
- Geberit Mepla avgrader og kalibreringsverktøy → s. 307

Geberit Mepla systemrør multilayer, rundt forhåndsisolert, kveil

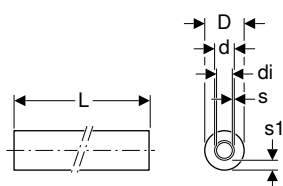

click & scan

Art. nr.	NRF nr.	DN	d, ø [mm]	di, ø [mm]	D [cm]	s1 [mm]	s [mm]	L [m]
Isolasjon: 13 mm								
601.136.00.1	2472916	12	16	11,5	4,2	13	2,25	50
602.136.00.1	2472918	15	20	15	4,6	13	2,5	50
603.136.00.1	2472919	20	26	20	5,2	13	3	25

Tilbehør

- Geberit Mepla avgrader og kalibreringsverktøy → s. 307
- Geberit Mepla saks → s. 306



Fittings

Koblinger

Geberit Mepla kopling

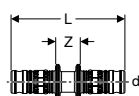

click & scan

Art. nr.	NRF nr.	DN	d, ø [mm]	L [cm]	Z [cm]
621.505.00.5	2472452	12	16	6,8	1,6
622.505.00.5	2472453	15	20	7,3	1,6
623.505.00.5	2472455	20	26	7,9	1,4
624.505.00.5	2472457	25	32	9	1,4
625.505.00.5	2472459	32	40	10,4	1,7
626.505.00.5	2472462	40	50	11,7	1,8
627.505.00.5	2472464	50	63	15,6	2
628.505.00.5	2472466	65	75	19,5	2,1

Geberit Mepla lang kopling

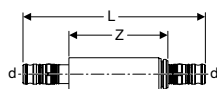

click & scan

Art. nr.	NRF nr.	DN	d, ø [mm]	L [cm]	Z [cm]
601.575.00.5	2472948	12	16	12,3	6,6
602.575.00.5	2472949	15	20	13,4	7,3
603.575.00.5	2472363	20	26	15,3	8,2
604.575.00.5	2472365	25	32	14,2	7,5
605.575.00.5	2472367	32	40	16,8	8,7
606.575.00.5	2472369	40	50	18,8	9,3

Reduksjoner

Geberit Mepla reduksjon

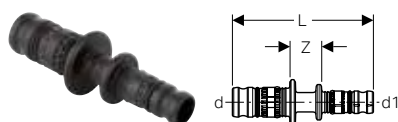

click & scan

Art. nr.	NRF nr.	DN	d, ø [mm]	d1, ø [mm]	L [cm]	Z [cm]
622.650.00.5	2472473	15 / 12	20	16	7,1	1,6
623.650.00.5	2472475	20 / 12	26	16	7,5	1,6
623.651.00.5	2472477	20 / 15	26	20	7,8	1,6
624.651.00.5	2472482	25 / 15	32	20	8,5	1,8
624.652.00.5	2472484	25 / 20	32	26	8,5	1,4
625.651.00.5	2472486	32 / 15	40	20	9	1,8
625.652.00.5	2472488	32 / 20	40	26	9,2	1,5
625.653.00.5	2472491	32 / 25	40	32	9,7	1,5
626.652.00.5	2472493	40 / 25	50	32	10,3	1,5
626.653.00.5	2472495	40 / 32	50	40	11,1	1,7
627.653.00.5	2472497	50 / 32	63	40	13,1	1,9
627.654.00.5	2472499	50 / 40	63	50	13,7	2
628.653.00.5	2472501	65 / 32	75	40	15,2	2,1
628.654.00.5	2472502	65 / 40	75	50	15,8	2,1
628.655.00.5	2472503	65 / 50	75	63	17,6	2,1

Albue

Geberit Mepla albue

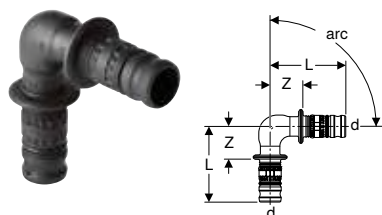

click & scan

Art. nr.	NRF nr.	DN	d, ø [mm]	L [cm]	Z [cm]
arc / Vinkel: 45°					
623.245.00.5	2472293	20	26	4,8	1,5
624.245.00.5	2472295	25	32	5,5	1,8
625.245.00.5	2472297	32	40	6,5	2,2
626.245.00.5	2472299	40	50	7,4	2,5
627.245.00.5	2472302	50	63	9,5	2,8
628.245.00.5	2472304	65	75	11,6	2,9
arc / Vinkel: 90°					
621.271.00.5	2472272	12	16	4,4	1,8
622.271.00.5	2472273	15	20	5,1	2,2
623.271.00.5	2472275	20	26	5,5	2,2
624.271.00.5	2472277	25	32	6,4	2,6
625.271.00.5	2472279	32	40	7,6	3,2
626.271.00.5	2472282	40	50	8,8	3,8
627.271.00.5	2472284	50	63	12	4,8
628.271.00.5	2472286	65	75	14,6	5,9

T-rør

Geberit Mepla T-rør likt

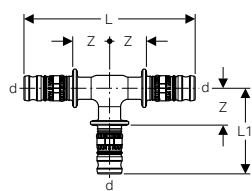

click & scan

Art. nr.	NRF nr.	DN	d, ø [mm]	arc [°]	L [cm]	L1 [cm]	Z [cm]
621.310.00.5	2472312	12	16	90	9,6	4,8	2,2
622.310.00.5	2472313	15	20	90	10,1	5,1	2,2
623.310.00.5	2472315	20	26	90	11	5,5	2,2
624.310.00.5	2472317	25	32	90	12,8	6,4	2,6
625.310.00.5	2472319	32	40	90	15,2	7,6	3,2
626.310.00.5	2472322	40	50	90	17,6	8,8	3,8
627.310.00.5	2472324	50	63	90	23,2	11,6	4,8
628.310.00.5	2472326	65	75	90	29,3	14,6	5,9

Geberit Mepla T-rør redusert

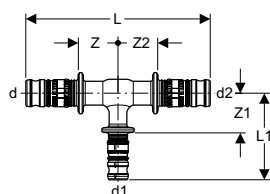

click & scan

Art. nr.	NRF nr.	DN	d, ø [mm]	d1, ø [mm]	d2, ø [mm]	arc [°]	L [cm]	L1 [cm]	Z [cm]	Z1 [cm]	Z2 [cm]
622.313.00.5	2472383	12 / 15 / 12	16	20	16	90	9,6	5,1	2,2	2,2	2,2
622.314.00.5	2472385	15 / 12 / 12	20	16	16	90	9,9	4,8	2,2	2,2	2,2
622.311.00.5	2472387	15 / 12 / 15	20	16	20	90	10,1	4,8	2,2	2,2	2,2
622.312.00.5	2472389	15 / 15 / 12	20	20	16	90	9,9	5,1	2,2	2,2	2,2
623.318.00.5	2472392	15 / 20 / 15	20	26	20	90	11,3	5,5	2,8	2,2	2,8
623.311.00.5	2472394	20 / 12 / 20	26	16	26	90	10	5,2	1,7	2,6	1,7
623.317.00.5	2472396	20 / 15 / 15	26	20	20	90	10,9	5,7	2,2	2,8	2,5
623.315.00.5	2472398	20 / 15 / 20	26	20	26	90	11	5,7	2,2	2,8	2,2
623.316.00.5	2472401	20 / 20 / 15	26	26	20	90	11,5	5,8	2,2	2,2	2,8
624.311.00.5	2472405	25 / 12 / 25	32	16	32	90	11,6	5,5	2	2,9	2
624.314.00.5	2472407	25 / 15 / 20	32	20	26	90	11,5	6	2,2	3,1	2,2
624.317.00.5	2472409	25 / 15 / 25	32	20	32	90	11,6	6	2	3,1	2
624.316.00.5	2472414	25 / 20 / 20	32	26	26	90	11,7	5,9	2,3	2,6	2,3
624.319.00.5	2472416	25 / 20 / 25	32	26	32	90	12,2	5,9	2,3	2,6	2,3
625.317.00.5	2472421	32 / 15 / 32	40	20	40	90	13,2	6,4	2,2	3,5	2,2
625.319.00.5	2472423	32 / 20 / 32	40	26	40	90	13,8	6,5	2,5	3,2	2,5
625.321.00.5	2472425	32 / 25 / 32	40	32	40	90	14,4	7,2	2,8	3,2	2,8
626.317.00.5	2472426	40 / 20 / 40	50	26	50	90	15,4	7,1	2,7	3,8	2,7
626.319.00.5	2472427	40 / 25 / 40	50	32	50	90	16	7,6	3	3,8	3
626.320.00.5	2472429	40 / 32 / 32	50	40	40	90	16,2	8,2	3,4	3,8	3,4
626.321.00.5	2472432	40 / 32 / 40	50	40	50	90	16,8	8,2	3,4	3,8	3,4
627.316.00.5	2472434	50 / 20 / 50	63	26	63	90	19,2	7,9	2,8	4,6	2,8
627.320.00.5	2472436	50 / 25 / 50	63	32	63	90	19,8	8,6	3,1	4,8	3,1
627.321.00.5	2472438	50 / 32 / 50	63	40	63	90	20,8	9,2	3,6	4,8	3,6
627.322.00.5	2472441	50 / 40 / 50	63	50	63	90	22	9,8	4,2	4,8	4,2
628.316.00.5	2472443	65 / 20 / 65	75	26	75	90	23,5	8,9	3,1	5,5	3,1
628.320.00.5	2472445	65 / 25 / 65	75	32	75	90	24	8,8	3,3	5	3,3
628.321.00.5	2472447	65 / 32 / 65	75	40	75	90	24,9	9,9	3,7	5,5	3,7
628.322.00.5	2472449	65 / 40 / 65	75	50	75	90	25,9	10,8	4,2	5,8	4,2
628.323.00.5	2472451	65 / 50 / 65	75	63	75	90	27,7	12,7	5,2	6	5,2

Geberit Mepla T-rør med innvendige gjenger

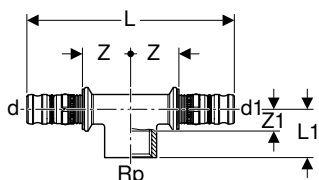

click & scan

Art. nr.	NRF nr.	DN	d, ø [mm]	Rp [°]	d1, ø [mm]	arc [°]	L [cm]	L1 [cm]	Z [cm]	Z1 [cm]
601.360.00.5	2472022	12 / 15 / 12	16	1/2"	16	90	9,8	2,4	2,4	0,9
602.360.00.5	2472333	15 / 15 / 15	20	1/2"	20	90	10,3	2,4	2,4	1,1
603.360.00.5	2472335	20 / 15 / 20	26	1/2"	26	90	11,2	2,6	2,4	1,3
603.362.00.5	2472339	20 / 20 / 20	26	3/4"	26	90	11,8	2,8	2,7	1,4
604.360.00.5	2472342	25 / 15 / 25	32	1/2"	32	90	10,6	3	2,5	1,7
604.362.00.5	2472344	25 / 20 / 25	32	3/4"	32	90	11,2	3,1	2,8	1,7
604.363.00.5	2472346	25 / 25 / 25	32	1"	32	90	12	3,5	3,2	1,8
605.360.00.5	2472348	32 / 15 / 32	40	1/2"	40	90	12	3,2	2,6	1,7
605.362.00.5	2472906	32 / 20 / 32	40	3/4"	40	90	12,6	3,5	2,9	2,2
605.363.00.5	2472351	32 / 25 / 32	40	1"	40	90	13,2	3,8	3,2	2,1
605.364.00.5	2472353	32 / 32 / 32	40	1 1/4"	40	90	14,4	4	3,8	2,1
606.361.00.5	2472352	40 / 15 / 40	50	1/2"	50	90	13,2	3,8	2,8	2,3
606.362.00.5	2472023	40 / 20 / 40	50	3/4"	50	90	13,8	4	3,1	2,7
606.363.00.5	2472354	40 / 25 / 40	50	1"	50	90	14,6	4,4	3,5	2,5
606.360.00.5	2472357	40 / 40 / 40	50	1 1/2"	50	90	16,6	4,5	4,5	2,6
607.360.00.5	2472356	50 / 15 / 50	63	1/2"	63	90	19,2	4,2	2,9	2,7
607.363.00.5	2472358	50 / 25 / 50	63	1"	63	90	20,6	4,8	3,6	2,9
607.366.00.5	2472359	50 / 50 / 50	63	2"	63	90	23,8	5,7	5,2	3,1
608.363.00.5	2472361	65 / 25 / 65	75	1"	75	90	26,1	5,1	4,4	2,9

Innvendig sirkulasjon

Geberit Mapress koplingssett for rør i rør til varmtvannssirkulasjon

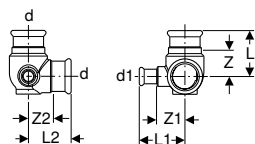

click & scan

Art. nr.	NRF nr.	DN	d, ø [mm]	d1, ø [mm]	arc [°]	L [cm]	L1 [cm]	L2 [cm]	Z [cm]	Z1 [cm]	Z2 [cm]
61275	1951031	25 / 12 / 25	28	15	90	5,8	5,7	5,4	3,5	3,7	3,1
61276	1951032	32 / 12 / 32	35	15	90	5,8	5,7	5,4	3,2	3,7	2,8

Geberit rør for rør i rør til varmtvannssirkulasjon

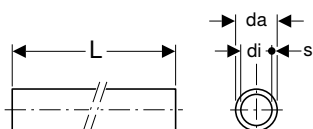

click & scan

Art. nr.	NRF nr.	da [mm]	di, ø [mm]	s [mm]	L [m]
600.101.00.2	1951034	14	11	1,5	50

Geberit kopping for rør for rør i rør til varmtvannssirkulasjon

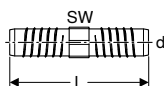

click & scan

Art. nr.	d, ø [mm]	L [cm]	SW [mm]
242.737.00.1	14	5,6	12

Overganger uløselige

Geberit FlowFit overgangsstykke til Geberit Mepla

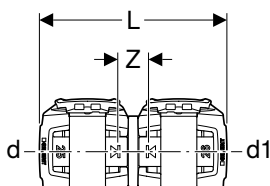

click & scan

Art. nr.	NRF nr.	DN	d, ø [mm]	d1, ø [mm]	s1 [mm]	L [cm]	Z [cm]
620.090.00.1	2473596	12	16	16	2,25	7,8	1,3
620.091.00.1	2473597	15	20	20	2,5	7,8	1,3
620.092.00.1	2473598	20	25	26	3	7,8	1,3
620.093.00.1	2473599	25	32	32	3	8,8	1,6
620.094.00.1	2473601	32	40	40	3,5	8,8	1,6
620.095.00.1	2473602	40	50	50	4	14	2,1
620.096.00.1	2473603	50	63	63	4,5	15	2,3
620.097.00.1	2473604	65	75	75	4,7	15	2,3

Geberit Mepla overgangsstykke til Geberit Mapress, med spissende

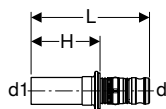

click & scan

Art. nr.	NRF nr.	DN	d, ø [mm]	d1, ø [mm]	L [cm]	H [cm]
601.507.00.5	2472922	12 / 10	16	12	5,8	3,3
601.508.00.5	2472241	12	16	15	5,9	3,4
602.507.00.5	2472248	15 / 12	20	15	6,1	3,4
602.508.00.5	2472242	15	20	18	6,1	3,4
602.509.00.5	2472923	15 / 20	20	22	6,2	3,5
603.508.00.5	2472243	20	26	22	6,7	3,5
604.508.00.5	2472244	25	32	28	6,6	3,7
605.508.00.5	2472245	32	40	35	7,5	4,1
606.508.00.5	2472246	40	50	42	10,1	6,3
607.508.00.5	2472247	50	63	54	13,6	7

Geberit Mepla overgangsstykke med utvendige gjenger



click & scan

Art. nr.	NRF nr.	DN	d, ø [mm]	R ["]	L [cm]	H [cm]
601.535.00.5	2472523	12 / 15	16	1/2"	5,4	2,8
601.536.00.5	2472932	12 / 20	16	3/4"	5,7	3,1
602.535.00.5	2472525	15	20	1/2"	5,7	3
602.536.00.5	2472527	15 / 20	20	3/4"	5,9	3,1
603.535.00.5	2472529	20 / 15	26	1/2"	6,3	3,1
603.536.00.5	2472532	20	26	3/4"	6,4	3,2
603.537.00.5	2472534	20 / 25	26	1"	6,7	3,5
604.537.00.5	2472536	25	32	1"	6,4	3,6
604.538.00.5	2472537	25 / 32	32	1 1/4"	6,6	3,9
605.537.00.5	2472538	32 / 25	40	1"	7,1	3,7
605.538.00.5	2472541	32	40	1 1/4"	7,4	4
605.539.00.5	2472542	32 / 40	40	1 1/2"	7,5	4,1
606.537.00.5	2472543	40	50	1 1/2"	8	4,2
606.540.00.5	2472544	40 / 50	50	2"	8,4	4,7
607.539.00.5	2472545	50	63	2"	11,7	5
607.541.00.5	2472546	50 / 65	63	2 1/2"	12,5	5,8
608.541.00.5	2472547	65	75	2 1/2"	14,7	6



- Overganger med NPT-gjenger på forespørsel

Geberit Mepla overgangsstykke med utvendige gjenger, ikke drikkevann



click & scan

Art. nr.	NRF nr.	DN	d, ø [mm]	R ["]	L [cm]	H [cm]
622.535.00.5	2472924	15	20	1/2"	5,6	2,8
623.536.00.5	2472925	20	26	3/4"	6,3	3
624.537.00.5	2472926	25	32	1"	7,3	3,5
625.538.00.5	2472927	32	40	1 1/4"	8,4	4
626.537.00.5	2472928	40	50	1 1/2"	9,2	4,2
627.539.00.5	2472929	50	63	2"	11,7	4,9
628.541.00.5	2472931	65	75	2 1/2"	14,6	5,9

Geberit Mepla overgangsstykke med utvendige gjenger NPT

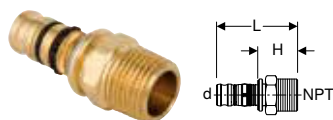

click & scan

Art. nr.	NRF nr.	DN	d, ø [mm]	NPT	L [cm]	H [cm]
661.535.00.5	2472938	12 / 15	16	1/2"	5,4	2,9
662.535.00.5	2472939	15	20	1/2"	5,7	3
663.536.00.5	2472941	20	26	3/4"	6,4	3,2
664.537.00.5	2472942	25	32	1"	6,4	3,6
665.538.00.5	2472943	32	40	1 1/4"	7,4	4
666.537.00.5	2472944	40	50	1 1/2"	8	4,2
667.539.00.5	2472945	50	63	2"	11,7	5

Geberit Mepla overgangsstykke med innvendige gjenger

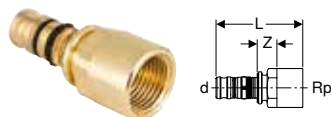

click & scan

Art. nr.	NRF nr.	DN	d, ø [mm]	Rp ["]	L [cm]	Z [cm]
601.555.00.5	2472563	12 / 15	16	1/2"	5,6	1,8
601.556.00.5	2472933	12 / 20	16	3/4"	5,9	1,7
602.555.00.5	2472565	15	20	1/2"	5,9	1,8
602.556.00.5	2472567	15 / 20	20	3/4"	6,1	1,9
603.556.00.5	2472569	20	26	3/4"	6,6	1,9
603.557.00.5	2472572	20 / 25	26	1"	7,1	2,2
604.557.00.5	2472574	25	32	1"	6,7	2,2
604.558.00.5	2472575	25 / 32	32	1 1/4"	7,4	2,3
605.557.00.5	2472576	32 / 25	40	1"	7,5	2,4
605.558.00.5	2472578	32	40	1 1/4"	7,7	2,4
605.559.00.5	2472577	32 / 40	40	1 1/2"	8,4	2,5
606.559.00.5	2472579	40	50	1 1/2"	8,8	2,7
606.560.00.5	2472581	40 / 50	50	2"	9,7	3,2
607.560.00.5	2472582	50	63	2"	12,7	3,3
607.561.00.5	2472583	50 / 65	63	2 1/2"	13,3	3,5
608.561.00.5	2472585	65	75	2 1/2"	14,7	2,9



Geberit Mepla albue 90° med utvendige gjenger

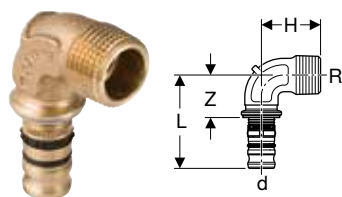

click & scan

Art. nr.	NRF nr.	DN	d, ø [mm]	R ["]	arc [°]	L [cm]	H [cm]	Z [cm]
601.252.00.5	2472223	12 / 15	16	1/2"	90	4,8	3	2,3
601.253.00.5	2472957	12 / 20	16	3/4"	90	4,8	3,4	2,3
602.252.00.5	2472225	15	20	1/2"	90	5,1	3,2	2,3
602.253.00.5	2472227	15 / 20	20	3/4"	90	5,3	3,4	2,5
603.253.00.5	2472229	20	26	3/4"	90	5,7	4	2,5
603.254.00.5	2472232	20 / 25	26	1"	90	5,9	4,3	2,7
604.254.00.5	2472234	25	32	1"	90	5,9	4,6	3,1
605.255.00.5	2472236	32	40	1 1/4"	90	7	5,3	3,6
606.255.00.5	2472238	40	50	1 1/2"	90	7,7	6	3,9
607.255.00.5	2472959	50	63	2"	90	11,6	7,5	4,9

Geberit Mepla albue 90° med innvendige gjenger

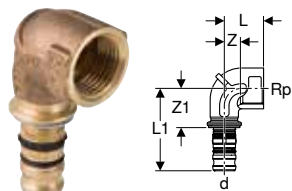

click & scan

Art. nr.	NRF nr.	DN	d, ø [mm]	Rp ["]	arc [°]	L [cm]	L1 [cm]	Z [cm]	Z1 [cm]
601.256.00.5	2472253	12 / 15	16	1/2"	90	2,2	5	0,9	2,4
601.257.00.5	2472958	12 / 20	16	3/4"	90	3,5	5	2	2,4
602.256.00.5	2472255	15	20	1/2"	90	2,5	5,3	1,2	2,5
602.257.00.5	2472257	15 / 20	20	3/4"	90	3,5	5,3	2	2,5
603.257.00.5	2472259	20	26	3/4"	90	3	6,1	1,5	2,9
603.258.00.5	2472263	20 / 25	26	1"	90	3,4	6,5	1,5	3,3
604.258.00.5	2472262	25	32	1"	90	3,6	6,2	1,9	3,4
605.259.00.5	2472264	32	40	1 1/4"	90	4,3	7,3	2,2	3,9
606.256.00.5	2472266	40	50	1 1/2"	90	4,8	8,1	2,8	4,3
607.256.00.5	2472269	50	63	2"	90	5,7	11,9	3,1	5,2

Overganger og forbindelser, løsbare

Geberit Mepla union

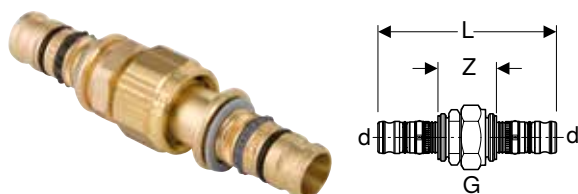

click & scan

Art. nr.	NRF nr.	DN	d, ø [mm]	G ["]	L [cm]	Z [cm]
601.571.00.5	2472593	12	16	1/2"	9,1	4,1
602.571.00.5	2472595	15	20	1/2"	9,9	4,4
603.571.00.5	2472597	20	26	3/4"	11	4,6
604.571.00.5	2472599	25	32	1"	11,5	5,8
605.571.00.5	2472602	32	40	1 1/4"	13,1	6,3
606.571.00.5	2472603	40	50	1 1/2"	14,3	6,7
607.571.00.5	2472604	50	63	2"	20,8	7,4

Geberit Mepla union med utvendige gjenger

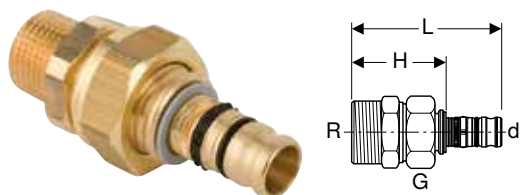

click & scan

Art. nr.	NRF nr.	DN	d, ø [mm]	R ["]	G ["]	L [cm]	H [cm]
601.590.00.5	2472613	12 / 15	16	1/2"	3/4"	7,2	4,7
602.590.00.5	2472615	15	20	1/2"	3/4"	7,4	4,7
602.591.00.5	2472616	15 / 20	20	3/4"	3/4"	7,4	4,7
603.590.00.5	2472617	20	26	3/4"	1"	8,3	5,1
604.590.00.5	2472619	25	32	1"	1 1/4"	8,7	5,9
604.591.00.5	2472621	25 / 32	32	1 1/4"	1 1/4"	9	6,1
605.590.00.5	2472622	32	40	1 1/4"	1 1/2"	9,6	6,2
605.591.00.5	2472623	32 / 40	40	1 1/2"	1 1/2"	10	6,5
606.590.00.5	2472624	40	50	1 1/2"	1 3/4"	12,1	8,3
606.591.00.5	2472625	40 / 50	50	2"	2"	11,4	7,6
607.590.00.5	2472626	50	63	2"	2 3/4"	14,8	8,1

Geberit Mepla union med innvendige gjenger

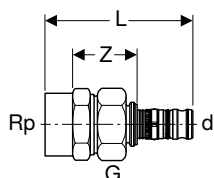

click & scan

Art. nr.	NRF nr.	DN	d, ø [mm]	Rp ["]	G ["]	L [cm]	Z [cm]
601.595.00.5	2472633	12 / 15	16	1/2"	3/4"	6,6	2,8
602.595.00.5	2472635	15	20	1/2"	3/4"	6,8	2,8
603.595.00.5	2472637	20	26	3/4"	1"	7,6	3
604.595.00.5	2472639	25	32	1"	1 1/4"	7	2,5
604.596.00.5	2472641	25 / 32	32	1 1/4"	1 1/4"	8,6	3,8
605.595.00.5	2472642	32	40	1 1/4"	1 1/2"	9	3,7
605.596.00.5	2472643	32 / 40	40	1 1/2"	1 1/2"	9,4	4,1
606.595.00.5	2472644	40	50	1 1/2"	1 3/4"	11,2	5,5
607.595.00.5	2472646	50	63	2"	2 3/4"	12,4	3,4

Geberit Mepla overgangsstykke med unionmutter

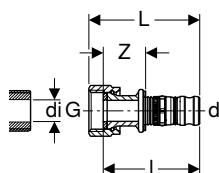

click & scan

Art. nr.	NRF nr.	DN	d, ø [mm]	G ["]	di, ø [mm]	L [cm]	l [cm]	Z [cm]
601.579.00.5	2472934	12	16	3/8"	11	5,2	4,6	2,1
601.582.00.5	2472653	12	16	1/2"	11	5,2	4,4	1,9
601.583.00.5	2472655	12	16	3/4"	17	4,9	3,9	1,4
601.584.00.5	2472935	12	16	1"	21	5,2	4	1,4
602.582.00.5	2472657	15	20	1/2"	11	5,6	4,9	2,2
602.583.00.5	2472659	15	20	3/4"	17	5,2	4,3	1,3
602.584.00.5	2472937	15	20	1"	21	5,6	4,1	1,5
602.581.00.5	2472936	15	20	1 1/8"	24	5,5	4,3	1,5
602.586.00.5	2472662	15	20	1 1/4"	27	5,5	4,4	1,7
602.585.00.5	2472664	15	20	1 1/2"	32	5,7	4,4	1,7
603.582.00.5	2472666	20	26	1/2"	11	6,3	5,5	2,4
603.583.00.5	2472668	20	26	3/4"	17	6,2	5,4	2,3
603.584.00.5	2472671	20	26	1"	21	5,6	4,8	1,5
603.586.00.5	2472673	20	26	1 1/4"	27	6	4,9	1,8
603.585.00.5	2472675	20	26	1 1/2"	32	6,2	4,9	1,7
604.583.00.5	2472677	25	32	3/4"	17	6,1	5,3	2,5
604.584.00.5	2472679	25	32	1"	21	6,7	4,8	2,9
604.586.00.5	2472682	25	32	1 1/4"	27	5,9	4,5	1,6
604.585.00.5	2472684	25	32	1 1/2"	32	5,8	4,6	1,7
604.581.00.5	2472685	25	32	2"	42	6	4,6	1,8
605.589.00.5	2472686	32	40	1 1/4"	27	7,6	6,5	3,1
605.585.00.5	2472688	32	40	1 1/2"	32	6,5	5,2	1,8
605.581.00.5	2472687	32	40	2"	42	6,6	5,2	1,9
606.585.00.5	2472689	40	50	1 1/2"	32	8,2	7,1	3,3
606.580.00.5	2472691	40	50	1 3/4"	36	8,1	7,3	3,4
606.581.00.5	2472693	40	50	2"	42	6,8	6	2,1
607.581.00.5	2472694	50	63	2"	42	11,5	10,3	3,6
607.587.00.5	2472695	50	63	2 1/2"	54	11,5	10,3	3,6

Presshylse, for Geberit Mepla løsfleenser PN 6 og PN 10/16

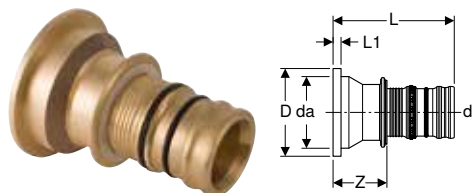

click & scan

Art. nr.	NRF nr.	DN	d, ø [mm]	da [mm]	D [cm]	L [cm]	L1 [cm]	Z
608.520.00.5	2472905	65	75	95	11,5	15,2	0,6	6,6

Bestilles i tillegg

- Geberit Mepla løsfleens PN 6 → s. 134
- Geberit Mepla løsfleens PN 10/16 → s. 134

Geberit Mepla løsfleens PN 6



click & scan

Art. nr.	NRF nr.	DN	di, ø [mm]	D [cm]	k [mm]	m [mm]	H [cm]	n [pc.]	PN [bar]
23799	2472946	65	97	16	130	14	1,6	4	6

Geberit Mepla løsfleens PN 10/16



click & scan

Art. nr.	NRF nr.	DN	di, ø [mm]	D [cm]	k [mm]	m [mm]	H [cm]	n [pc.]	PN [bar]
63789	2472947	65	97	18,5	145	18	1,6	4	10 / 16

Endedeksler

Geberit Mepla plugg



click & scan

Art. nr.	NRF nr.	DN	d, ø [mm]	L [cm]	l [cm]
621.000.00.5	2473421	12	16	3,4	2,6
622.000.00.5	2473422	15	20	3,7	2,9
623.000.00.5	2473423	20	26	4,2	3,3

Tilkoblinger

Geberit Mepla tilkopplingsbend 90°

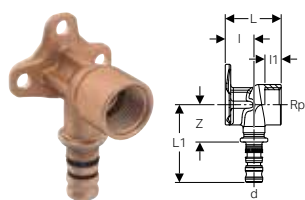

click & scan

Art. nr.	NRF nr.	DN	d, ø [mm]	Rp ["]	arc [°]	L1 [cm]	I [cm]	I1 [cm]	Z [cm]
L / Lengde: 3,6 cm									
601.289.00.5	2472123	12	16	1/2"	90	5	1,8	1,3	2,5
602.289.00.5	2472125	15	20	1/2"	90	5,5	1,8	1,3	2,7
L / Lengde: 5,2 cm									
601.293.00.5	2472907	12	16	1/2"	90	5	1,8	2,6	2,5
602.293.00.5	2472909	15	20	1/2"	90	5,5	1,8	2,6	2,7
602.294.00.5	2472911	15	20	3/4"	90	5,5	1,8	1,9	2,7
L / Lengde: 7,8 cm									
601.296.00.5	2472908	12	16	1/2"	90	6,5	1,8	3	4
602.296.00.5	2472912	15	20	1/2"	90	7	1,8	3	4,2

Geberit Mepla dobbel tilkopplingsbend 90°

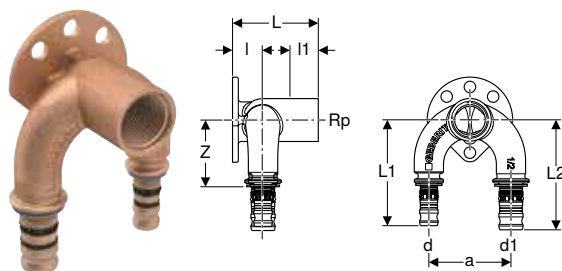

click & scan

Art. nr.	NRF nr.	DN	d, ø [mm]	Rp ["]	d1, ø [mm]	arc [°]	a [cm]	L1 [cm]	L2 [cm]	I [cm]	I1 [cm]	Z [cm]
L / Lengde: 5,2 cm												
601.273.00.5	2472953	12	16	1/2"	16	90	5	6,5	6,5	1,9	2,4	4
602.274.00.5	2472955	12 / 15	16	1/2"	20	90	5	6,5	6,7	1,9	2,4	4
602.275.00.5	2472956	15 / 12	20	1/2"	16	90	5	6,7	6,5	1,9	2,4	4
602.273.00.5	2472954	15	20	1/2"	20	90	5	6,7	6,7	1,9	2,4	4

Fordeler med gjengestuss

Geberit fordeler med gjenge og gjenge for fordeler til eurokonus

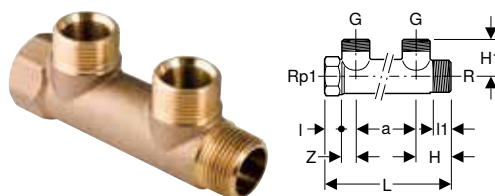

click & scan

Art. nr.	NRF nr.	DN	R ["]	G ["]	Rp1 ["]	a [cm]	L [cm]	I [cm]	I1 [cm]	H [cm]	H1 [cm]	Z [cm]	Antall avløp
602.422.00.1	2472903	20 / 15 / 20	3/4"	3/4"	3/4"	5	10,9	1,5	1,5	3,2	3,2	1,3	2
602.423.00.1	2472904	20 / 15 / 20	3/4"	3/4"	3/4"	5	16	1,5	1,5	3,2	3,2	1,3	3



- Feste med isolert Geberit brakett (art. nr. 601.853.26.1)

Geberit Mepla gjenge for fordeler til eurokonus

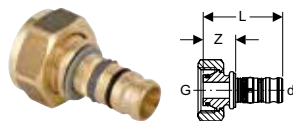

click & scan

Art. nr.	NRF nr.	DN	d, ø [mm]	G ["]	L [cm]	Z [cm]
601.623.00.5	2472951	12	16	3/4"	4,7	1,2
602.623.00.5	2472952	15	20	3/4"	5	1,2

Tilkoblinger for varme

Geberit Mepla overgangsstykke med utvendige gjenger



click & scan

Art. nr.	DN	d, ø [mm]	R ["]	L [cm]	H [cm]
612.535.22.5	15	20	1/2"	5,7	3
612.536.22.5	15 / 20	20	3/4"	5,9	3,1
613.536.22.5	20	26	3/4"	6,4	3,2

Geberit Mepla overgangsstykke med unionmutter

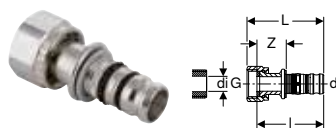

click & scan

Art. nr.	DN	d, ø [mm]	G ["]	di, ø [mm]	L [cm]	I [cm]	Z [cm]
611.582.22.5	12	16	1/2"	11	5,2	4,4	1,9
612.582.22.5	15	20	1/2"	11	5,6	4,9	2,2
613.583.22.5	20	26	3/4"	17	6,2	5,4	2,3

Tilbehør

Beskyttelse for rør og fittings

Geberit beskyttelsestape

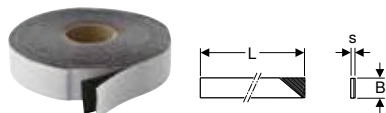

click & scan

Art. nr.	NRF nr.	s [mm]	L [m]	B [cm]
601.813.00.1	2472901	1	12,5	3
601.815.00.1	2472902	1	12,5	5



- Sett på etter trykkontroll

Geberit Mepla pakningsring

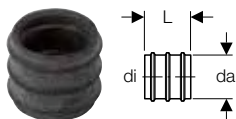

click & scan

Art. nr.	da [mm]	di, ø [mm]	L [cm]
601.811.00.1	19	16	2
602.811.00.1	23	20	2,1
603.811.00.1	29	26	2,3

Klammer for rør

Geberit klammerinnlegg

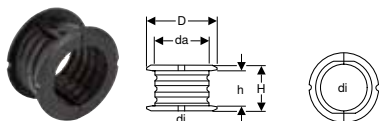

click & scan

Art. nr.	NRF nr.	da [mm]	di, ø [mm]	D [cm]	H [cm]	h [cm]
603.702.00.1	2472753	32	25 / 26	3,4	3,2	2,5
604.702.00.1	2472755	40	32	4,9	3,2	2,5
605.702.00.1	2472757	50	40	5,7	3,3	2,5
606.702.00.1	2472759	63	50	7,6	3,4	2,5
607.702.00.1	2472761	75	63	9,1	4,8	3
608.702.00.1	2472762	90	75	10,7	5	3

Geberit bæreskall forsinket og lakkert

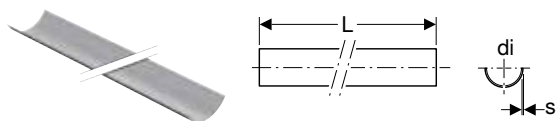

click & scan

Art. nr.	Farge / overflate	DN	di, ø [mm]	s [mm]	L [m]
360.850.00.1	Lakkert	40	40	0,75	3
361.850.00.1	Lakkert	50	50	0,75	3
364.850.00.1	Lakkert	60	63	0,75	3
365.850.00.1	Lakkert	70	75	0,75	3
388.126.00.1	Lakkert		20	0,75	3
388.128.00.1	Lakkert		32	0,75	3
388.127.00.1	Lakkert		25-26	0,75	3

Geberit bunnplate rektangulær, to hull, med gjenget rørmuffe M8/M10

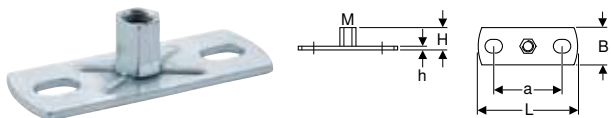

click & scan

Art. nr.	NRF nr.	M [mm]	a [cm]	L [cm]	B [cm]	H [cm]	h [cm]
362.848.26.1	2290373	8 / 10	5,4	8	3	1,9	0,3

Geberit bunnplate rektangulær, to hull, med gjenget rørmuffe M10 / G 1/2"

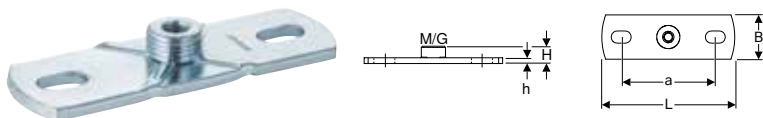

click & scan

Art. nr.	NRF nr.	G ["]	M [mm]	a [cm]	L [cm]	B [cm]	H [cm]	h [cm]
362.851.26.1	2290374	1/2"	10	8,5	12	4	1,5	0,5



Geberit FlowFit

Bruksoversikt – Geberit FlowFit.....	141
Systemrør multilayer	142
Fittings	143
Koblinger.....	143
Reduksjoner.....	144
Bend	145
T-stykker.....	145
Innvendig sirkulasjon.....	147
Overganger uløselige	148
Overganger og forbindelser, løsbare	152
Endedekslar.....	155
Tilkoblinger	156
Fordeler med gjengestuss.....	156
Adapters and connections for heating, detachable	156
Tilbehør	157
Beskyttelse for rør og fittings	157
Klammer for rør	157
Forbruksmateriell	158



Bruksoversikt – Geberit FlowFit

Geberit Norge, Versjon: oktober 2023

Bruksformål	Driftstemperatur	Maximum operating pressure	Systemrør		
			ML	ML therm NPW	PB
Flytende medier					
For drikkevann kaldt og varmt	0–70 °C ²⁾	10 bar /1000 kPa	✓		✓
For cold potable water	0–20 °C	Maximum operating pressure	✓		✓
Til avkjøling og oppvarming av vann uten frostvæske	0–80 °C ³⁾	10 bar /1000 kPa	✓	✓	
Til avkjøling og oppvarming av vann med frostvæske	-10–+40 °C ⁴⁾	10 bar /1000 kPa	✓	✓	
For industri- og prosessvann	0–70 °C	10 bar /1000 kPa	5)	5)	5)
Til ultrarent vann	0–70 °C	10 bar /1000 kPa	✓ ⁶⁾	✓ ⁶⁾	✓ ⁶⁾
For regnvann med pH-verdi > 6,0	0–70 °C	10 bar /1000 kPa	✓	✓	✓
For sjøvann	0–70 °C	10 bar /1000 kPa	✓	✓	
For kjemikalier og tekniske væsker	Ved forespørsel	Ved forespørsel	5)	5)	5)
Gassmedier					
For trykkluft (renhetsklasse olje 0–3)	0–70 °C	10 bar /1000 kPa	✓	✓	
Ved undertrykk ¹⁾	0–70 °C	Abs. ≥ 0,2 bar/20 kPa	✓	✓	

✓ Bruk er generelt godkjent når de definerte tilleggskravene iht. fotnotene er oppfylt

¹⁾ Utnyttbart undertrykk i Geberit rørsystem:

Det utnyttbare undertrykket er resultatet av lufttrykket på installasjonsstedet minus absoluttrykket på 200 mbar.

Eksempel: 980 mbar lufttrykk – 200 mbar absoluttrykk = 780 mbar utnyttbart trykk i rørsystemet

²⁾ Feiltemperatur iht. EN 806/-2: Tmal = 95 °C, totalt 100 h i løpet av levetiden

³⁾ Feiltemperatur iht. ISO 10508/2006: Tmal = 100 °C, totalt 100 h i løpet av levetiden

⁴⁾ Høyere temperaturer bare etter godkjenning fra Geberit

⁵⁾ Etter godkjenning fra Geberit

⁶⁾ Bruksområde i henhold til teknisk informasjon (TI) "Bearbeidet vann"

⁷⁾ pH-verdi ≥ 7,0 tillatt i forbindelse med silisiumbronse eller messing

⁸⁾ Renhetsklasse olje iht. ISO 8573-1:2010E; du finner informasjon om fuktighet og partikler i teknisk informasjon "Geberit rørledningssystemer for trykkluftinstallasjoner"



- For hver bruk må driftsbetingelsene i de retningsgivende tillatelsene, normene og tekniske regelverkene overholdes. Disse kan avvike fra angivelsene ovenfor.

	Fittings					O-ringer	Planpakninger for skrueforbindelser	Flenspakninger
	Plast	Blyfritt rødgods	Blyfri silisiumbrøse	Messing	Syrefast stål	EPDM svart	Fiberkomposittmateriale	Fiberkomposittmateriale
	✓	✓	✓	✓	✓	✓	✓	✓
	✓	✓	✓	✓	✓	✓	✓	✓
	✓	✓	✓	✓	✓	✓	✓	✓
	✓	✓	✓	✓	✓	✓	✓	✓
	5)	5)	5)		5)	5)	5)	5)
	✓6)	✓6)	✓6)		✓6)	✓6)	✓6)	✓6)
	✓	✓	✓7)	✓7)	✓	✓	✓	✓
	✓	✓	✓			✓	✓	✓
	5)	5)	5)	5)	5)	5)	5)	5)
	✓	✓	✓	✓	✓	✓8)	✓	✓
	✓	✓	✓	✓	✓	✓	✓	✓



Systemrør multilayer

Geberit systemrør multilayer, rette lengder

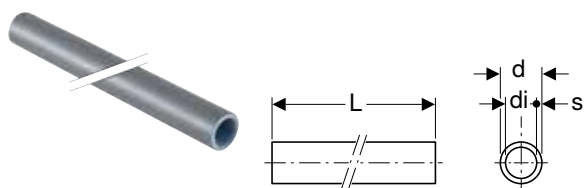

click & scan

Art. nr.	NRF nr.	DN	d, ø [mm]	di, ø [mm]	s [mm]
L / Lengde: 3 m					
619.010.00.1	2473472	12	16	12	2
619.011.00.1	2473473	15	20	16	2
619.012.00.1	2473474	20	25	20	2,5
619.013.00.1	2473475	25	32	26,4	2,8
619.014.00.1	2473476	32	40	34	3
619.015.00.1	2473477	40	50	42,4	3,8
619.016.00.1	2473478	50	63	55	4
L / Lengde: 5 m					
619.020.00.1	2473479	12	16	12	2
619.021.00.1	2473481	15	20	16	2
619.022.00.1	2473482	20	25	20	2,5
619.023.00.1	2473483	25	32	26,4	2,8
619.024.00.1	2473484	32	40	34	3
619.025.00.1	2473485	40	50	42,4	3,8
619.026.00.1	2473486	50	63	55	4
619.027.00.1	2473487	65	75	65,8	4,6

Tilbehør

- Geberit saks → s. 298
- Geberit FlowFit kalibreringsverktøy → s. 299
- Geberit rørkutter ML → s. 298
- Geberit sett for fastpunkt → s. 157

Geberit systemrør multilayer, kveil

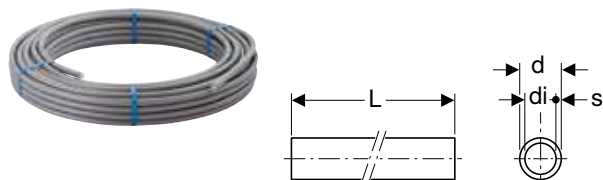

click & scan

Art. nr.	NRF nr.	DN	d, ø [mm]	di, ø [mm]	s [mm]	L [m]
619.050.00.1	2473488	12	16	12	2	50
619.060.00.1	2473489	12	16	12	2	120
619.051.00.1	2473491	15	20	16	2	50
619.061.00.1	2473492	15	20	16	2	100
619.052.00.1	2473493	20	25	20	2,5	50

Tilbehør

- Geberit saks → s. 298
- Geberit FlowFit kalibreringsverktøy → s. 299
- Geberit rørkutter ML → s. 298

Geberit systemrør multilayer, i beskyttelsesrør, kveil

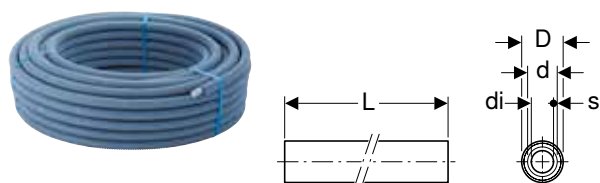

click & scan

Art. nr.	NRF nr.	DN	d, ø [mm]	di, ø [mm]	D [cm]	s [mm]	L [m]
619.220.00.1	2473494	12	16	12	2,7	2	50
619.221.00.1	2473495	15	20	16	3,1	2	50

Tilbehør

- Geberit saks → s. 298
- Geberit FlowFit kalibreringsverktøy → s. 299

Geberit systemrør multilayer, rundt forhåndsisolert, kveil

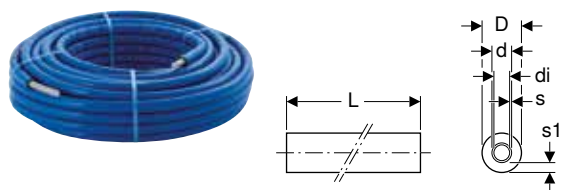

click & scan

Art. nr.	NRF nr.	DN	d, ø [mm]	di, ø [mm]	D [cm]	s1 [mm]	s [mm]	L [m]
Isolasjon: 13 mm								
619.140.00.1	2473496	12	16	12	4,2	13	2	50
619.141.00.1	2473497	15	20	16	4,6	13	2	50
619.142.00.1	2473498	20	25	20	5,1	13	2,5	25

Tilbehør

- Geberit saks → s. 298
- Geberit rørkutter ML → s. 298
- Geberit FlowFit kalibreringsverktøy → s. 299

Fittings

Koblinger

Geberit FlowFit kobling

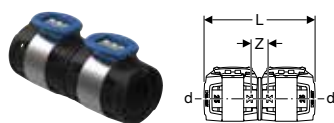

click & scan

Art. nr.	NRF nr.	DN	d, ø [mm]	L [cm]	Z [cm]
620.010.00.1	2473499	12	16	7,7	1,2
620.011.00.1	2473501	15	20	7,7	1,2
620.012.00.1	2473502	20	25	7,7	1,2
620.013.00.1	2473503	25	32	8,7	1,5
620.014.00.1	2473504	32	40	8,7	1,5
620.015.00.1	2473505	40	50	14,1	2,2
620.016.00.1	2473506	50	63	15,1	2,4
620.017.00.1	2473507	65	75	15,1	2,4

Geberit FlowFit lang kobling

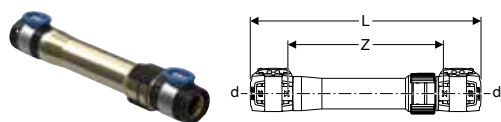

click & scan

Art. nr.	NRF nr.	DN	d, ø [mm]	L [cm]	Z [cm]
620.020.00.1	2473508	12	16	20	13,5
620.021.00.1	2473509	15	20	20	13,5
620.022.00.1	2473511	20	25	20	13,5
620.023.00.1	2473512	25	32	22,2	15
620.024.00.1	2473513	32	40	23,5	16,3
620.025.00.1	2473514	40	50	34	22

Reduksjoner

Geberit FlowFit reduksjon

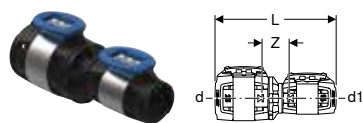

click & scan

Art. nr.	NRF nr.	DN	d, ø [mm]	d1, ø [mm]	L [cm]	Z [cm]
620.031.00.1	2473515	15 / 12	20	16	8,4	1,9
620.032.00.1	2473516	20 / 12	25	16	8,4	1,9
620.042.00.1	2473517	20 / 15	25	20	8,4	1,9
620.033.00.1	2473518	25 / 15	32	20	8,9	2
620.043.00.1	2473519	25 / 20	32	25	8,9	2
620.034.00.1	2473521	32 / 15	40	20	9,2	2,3
620.044.00.1	2473522	32 / 20	40	25	8,9	2
620.054.00.1	2473523	32 / 25	40	32	9,4	2,1
620.035.00.1	2473524	40 / 25	50	32	12,2	2,7
620.045.00.1	2473525	40 / 32	50	40	12,2	2,7
620.036.00.1	2473526	50 / 32	63	40	12,9	3
620.046.00.1	2473527	50 / 40	63	50	15,7	3,4
620.037.00.1	2473528	65 / 32	75	40	13,6	3,7
620.047.00.1	2473529	65 / 40	75	50	15,7	3,4
620.057.00.1	2473531	65 / 50	75	63	16,2	3,5

Bend

Geberit FlowFit bend

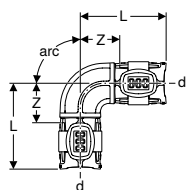

click & scan

Art. nr.	NRF nr.		DN	d, ø [mm]	L [cm]	Z [cm]
arc / Vinkel: 45°						
620.061.00.1	2472121	N	15	20	5,5	1,9
620.062.00.1	2473424		20	25	5,2	1,9
620.063.00.1	2473425		25	32	5,9	2,3
620.064.00.1	2473426		32	40	5,9	2,5
620.065.00.1	2473427		40	50	9	3
620.066.00.1	2473428		50	63	9,9	3,5
620.067.00.1	2473429		65	75	9,9	3,5
arc / Vinkel: 90°						
620.070.00.1	2473431		12	16	5,8	2,5
620.071.00.1	2473432		15	20	6	2,7
620.072.00.1	2473433		20	25	6,2	2,9
620.073.00.1	2473434		25	32	7	3,4
620.074.00.1	2473435		32	40	7,5	3,9
620.075.00.1	2473436		40	50	11,5	5,6
620.076.00.1	2473437		50	63	12,5	6,1
620.077.00.1	2473438		65	75	13	6,7

N: Ny, kan leveres fra april 2024

T-rør

Geberit FlowFit T-rør, likt

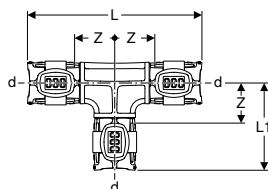

click & scan

Art. nr.	NRF nr.		DN	d, ø [mm]	arc [°]	L [cm]	L1 [cm]	Z [cm]
620.080.00.1	2473532		12	16	90	11,5	5,8	2,5
620.081.00.1	2473533		15	20	90	11,9	6	2,7
620.082.00.1	2473534		20	25	90	12,4	6,2	2,9
620.083.00.1	2473535		25	32	90	14	7	3,4
620.084.00.1	2473536		32	40	90	15	7,5	3,9
620.085.00.1	2473537		40	50	90	23	11,5	5,6
620.086.00.1	2473538		50	63	90	24,9	12,5	6,1
620.087.00.1	2473539		65	75	90	26,1	13,1	6,7

Geberit FlowFit redusert T-rør

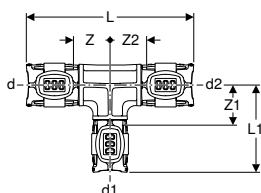

click & scan

Art. nr.	NRF nr.	DN	d, ø [mm]	d1, ø [mm]	d2, ø [mm]	arc [°]	L [cm]	L1 [cm]	Z [cm]	Z1 [cm]	Z2 [cm]
620.121.00.1	2473543	12 / 15 / 12	16	20	16	90	11,9	5,8	2,7	2,5	2,7
620.101.00.1	2473542	15 / 12 / 12	20	16	16	90	11,5	6	2,4	2,7	2,5
620.111.00.1	2473541	15 / 12 / 15	20	16	20	90	11,5	6	2,5	2,7	2,5
620.131.00.1	2473545	15 / 15 / 12	20	20	16	90	11,9	6	2,7	2,7	2,7
620.132.00.1	2473565	15 / 20 / 15	20	25	20	90	12,4	6	2,9	2,7	2,9
620.100.00.1	2472122	N 20 / 12 / 12	25	16	16	90	11,5	6	2,4	2,7	2,5
620.108.00.1	2472074	N 20 / 12 / 15	25	16	20	90	11,9	6,2	2,7	2,9	2,7
620.112.00.1	2473552	20 / 12 / 20	25	16	25	90	11,5	6,2	2,5	2,9	2,5
620.102.00.1	2473544	20 / 15 / 15	25	20	20	90	11,9	6,2	2,7	2,9	2,7
620.122.00.1	2473558	20 / 15 / 20	25	20	25	90	11,9	6,2	2,7	2,9	2,7
620.142.00.1	2473571	20 / 20 / 15	25	25	20	90	12,4	6,2	2,9	2,9	2,9
620.113.00.1	2473553	25 / 12 / 25	32	16	32	90	12	6,7	2,4	3,4	2,4
620.123.00.1	2473559	25 / 15 / 20	32	20	25	90	12,2	6,7	2,7	3,4	2,7
620.133.00.1	2473566	25 / 15 / 25	32	20	32	90	12,5	6,7	2,7	3,4	2,7
620.103.00.1	2473546	25 / 20 / 20	32	25	25	90	12,7	6,7	2,9	3,4	2,9
620.143.00.1	2473572	25 / 20 / 25	32	25	32	90	13	6,7	2,9	3,4	2,9
620.104.00.1	2473547	32 / 15 / 32	40	20	40	90	12,7	7,2	2,8	3,9	2,8
620.114.00.1	2473554	32 / 20 / 32	40	25	40	90	13,2	7,1	3	3,8	3
620.124.00.1	2473561	32 / 25 / 32	40	32	40	90	14,2	7,4	3,5	3,8	3,5
620.115.00.1	2473555	40 / 20 / 40	50	25	50	90	18,9	8,3	3,5	5	3,5
620.125.00.1	2473562	40 / 25 / 40	50	32	50	90	19,9	8,6	4	5	4
620.105.00.1	2473548	40 / 32 / 32	50	40	40	90	17,9	8,7	4	5	4,4
620.135.00.1	2473567	40 / 32 / 40	50	40	50	90	20,7	8,7	4,4	5	4,4
620.106.00.1	2473549	50 / 20 / 50	63	25	63	90	19,4	9	3,4	5,7	3,4
620.116.00.1	2473556	50 / 25 / 50	63	32	63	90	20,4	9,3	3,9	5,7	3,9
620.126.00.1	2473563	50 / 32 / 50	63	40	63	90	21,2	9,4	4,3	5,8	4,3
620.136.00.1	2473568	50 / 40 / 50	63	50	63	90	23,5	12,2	5,4	6,3	5,4
620.107.00.1	2473551	65 / 20 / 65	75	25	75	90	19,4	9,6	3,4	6,3	3,4
620.117.00.1	2473557	65 / 25 / 65	75	32	75	90	20,4	9,9	3,9	6,3	3,9
620.127.00.1	2473564	65 / 32 / 65	75	40	75	90	21,2	10	4,3	6,4	4,3
620.137.00.1	2473569	65 / 40 / 65	75	50	75	90	23,5	12,8	5,4	6,9	5,4
620.147.00.1	2473573	65 / 50 / 65	75	63	75	90	24,9	13	6,1	6,7	6,1

N: Ny, kan leveres fra april 2024

Geberit FlowFit T-rør med innvendige gjenger

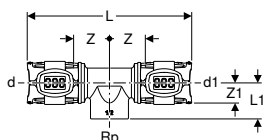

click & scan

Art. nr.	NRF nr.	DN	d, ø [mm]	Rp [°]	d1, ø [mm]	arc [°]	L [cm]	L1 [cm]	Z [cm]	Z1 [cm]
620.150.00.1	2473574	12 / 15 / 12	16	1/2"	16	90	11,9	2,4	2,7	1,1
620.151.00.1	2473575	15	20	1/2"	20	90	11,9	2,4	2,7	1,1
620.157.00.1	2473582	20 / 15 / 15	25	1/2"	20	90	11,9	2,6	2,7	1,3
620.152.00.1	2473576	20 / 15 / 20	25	1/2"	25	90	11,9	2,6	2,7	1,3
620.162.00.1	2473583	20	25	3/4"	25	90	12,8	2,8	3,1	1,5
620.153.00.1	2473577	25 / 15 / 25	32	1/2"	32	90	13	3,1	2,9	1,3
620.163.00.1	2473584	25 / 20 / 25	32	3/4"	32	90	13,4	3,1	3,1	1,7
620.173.00.1	2473588	25	32	1"	32	90	14,4	3,1	3,6	1,6
620.154.00.1	2473578	32 / 15 / 32	40	1/2"	40	90	13,4	3,4	3,1	1,9
620.164.00.1	2473585	32 / 20 / 32	40	3/4"	40	90	14,7	3,5	3,8	2,1
620.174.00.1	2473589	32 / 25 / 32	40	1"	40	90	14,7	4,2	3,8	2,3
620.184.00.1	2473594	32	40	1 1/4"	40	90	15,4	4,4	4,1	2,3
620.155.00.1	2473579	40 / 15 / 40	50	1/2"	50	90	18,5	4,1	3,3	2,4

Art. nr.	NRF nr.	DN	d, ø [mm]	Rp ["]	d1, ø [mm]	arc [°]	L [cm]	L1 [cm]	Z [cm]	Z1 [cm]
620.185.00.1	2473595	40	50	1 1/2"	50	90	22	4,6	5,1	2,3
620.165.00.1	2473586	40 / 20 / 40	50	3/4"	50	90	20,2	4	4,2	2,6
620.175.00.1	2473591	40 / 25 / 40	50	1"	50	90	20,2	4,6	4,2	2,5
620.156.00.1	2473581	50 / 15 / 50	63	1/2"	63	90	20,5	4,6	3,9	3,1
620.166.00.1	2473587	50 / 25 / 50	63	1"	63	90	22	5,1	4,7	3,2
620.176.00.1	2473593	50	63	2"	63	90	24,6	6,6	6	4
620.177.00.1	2473592	65 / 25 / 65	75	1"	75	90	21,6	5,4	4,5	3,5

Ny

Geberit FlowFit T-rør med innvendig gjenge på siden

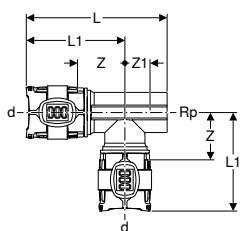

click & scan



Art. nr.	NRF nr.	DN	d, ø [mm]	Rp ["]	arc [°]	L [cm]	L1 [cm]	Z [cm]	Z1 [cm]
620.353.00.1	2472119	25 / 25 / 15	32	1/2"	90	10,2	7,1	3,4	1,6
620.354.00.1	2472106	32 / 32 / 15	40	1/2"	90	11,1	7,6	3,9	2
620.355.00.1	2472108	40 / 40 / 15	50	1/2"	90	15,5	11,7	5,6	2,3

Kan leveres fra april 2024

Innvendig sirkulasjon

Geberit Mapress koplingssett for rør i rør til varmtvannssirkulasjon

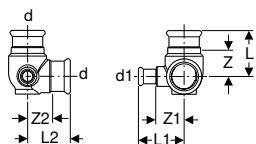

click & scan

Art. nr.	NRF nr.	DN	d, ø [mm]	d1, ø [mm]	arc [°]	L [cm]	L1 [cm]	L2 [cm]	Z [cm]	Z1 [cm]	Z2 [cm]
61275	1951031	25 / 12 / 25	28	15	90	5,8	5,7	5,4	3,5	3,7	3,1
61276	1951032	32 / 12 / 32	35	15	90	5,8	5,7	5,4	3,2	3,7	2,8

Geberit rør for rør i rør til varmtvannssirkulasjon

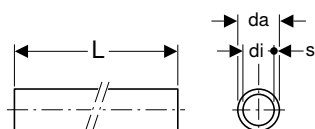

click & scan

Art. nr.	NRF nr.	da [mm]	di, ø [mm]	s [mm]	L [m]
600.101.00.2	1951034	14	11	1,5	50

Geberit koping for rør for rør i rør til varmtvannssirkulasjon

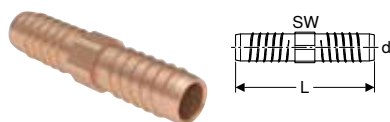

click & scan

Art. nr.	d, \emptyset [mm]	L [cm]	SW [mm]
242.737.00.1	14	5,6	12

Overganger uløselige

Geberit FlowFit overgangsstykke til Geberit Mepla

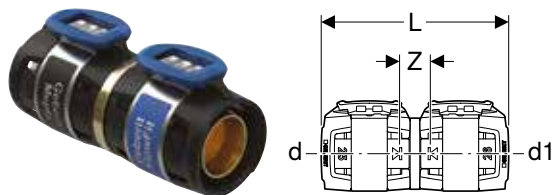

click & scan

Art. nr.	NRF nr.	DN	d, \emptyset [mm]	d1, \emptyset [mm]	s1 [mm]	L [cm]	Z [cm]
620.090.00.1	2473596	12	16	16	2,25	7,8	1,3
620.091.00.1	2473597	15	20	20	2,5	7,8	1,3
620.092.00.1	2473598	20	25	26	3	7,8	1,3
620.093.00.1	2473599	25	32	32	3	8,8	1,6
620.094.00.1	2473601	32	40	40	3,5	8,8	1,6
620.095.00.1	2473602	40	50	50	4	14	2,1
620.096.00.1	2473603	50	63	63	4,5	15	2,3
620.097.00.1	2473604	65	75	75	4,7	15	2,3

Geberit FlowFit overgangsstykke til Geberit Mapress, med spissende

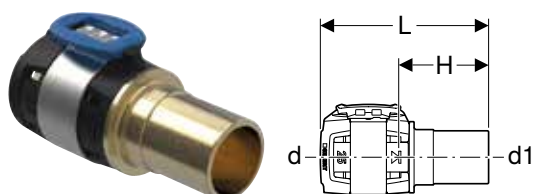

click & scan

Art. nr.	NRF nr.	DN	d, \emptyset [mm]	d1, \emptyset [mm]	L [cm]	H [cm]
620.230.00.1	2473605	12 / 10	16	12	6,8	3,5
620.240.00.1	2473606	12	16	15	6,9	3,6
620.231.00.1	2473607	15 / 12	20	15	6,9	3,6
620.241.00.1	2473615	15	20	18	6,9	3,6
620.242.00.1	2473608	15 / 20	20	22	7	3,7
620.232.00.1	2473609	20	25	22	7	3,7
620.233.00.1	2473611	25	32	28	7,7	4,1
620.234.00.1	2473612	32	40	35	8	4,4
620.235.00.1	2473613	40	50	42	12,8	6,9
620.236.00.1	2473614	50	63	54	13,8	7,5

Geberit FlowFit overgangsstykke til Geberit Mapress, med spissende, syrefast

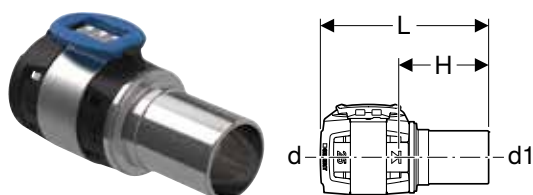

click & scan

Art. nr.	NRF nr.	DN	d, ø [mm]	d1, ø [mm]	L [cm]	H [cm]
620.250.00.1	2473616	12	16	15	7,1	3,8
620.252.00.1	2473618	15 / 20	20	22	7,2	3,9
620.253.00.1	2473619	20	25	22	7,2	3,9
620.254.00.1	2473621	25	32	28	7,9	4,3
620.255.00.1	2473622	32	40	35	8,2	4,6
620.256.00.1	2473623	40	50	42	12,5	6,6
620.257.00.1	2473624	50	63	54	14,2	7,9

Geberit FlowFit overgangsstykke til Geberit Mapress, med sammenføring, syrefast

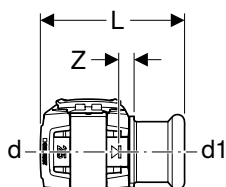

click & scan

Art. nr.	NRF nr.	DN	d, ø [mm]	d1, ø [mm]	L [cm]	Z [cm]
620.329.00.1	2472046	12 / 10	16	12	5,4	0,6
620.332.00.1	2472047	12	16	15	5,6	0,6
620.347.00.1	2472058	15 / 12	20	15	5,6	0,6
620.333.00.1	2472048	15	20	18	5,6	0,6
620.334.00.1	2472049	15 / 20	20	22	5,7	0,6
620.335.00.1	2472051	20	25	22	5,7	0,6
620.336.00.1	2472052	25	32	28	6,4	0,8
620.337.00.1	2472053	32	40	35	6,7	0,8
620.338.00.1	2472054	40	50	42	9,7	1,1
620.339.00.1	2472055	50	63	54	10,7	1,2



Geberit FlowFit overgangsstykke med utvendige gjenger

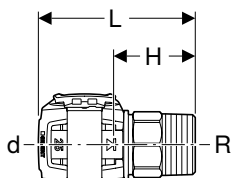

click & scan

Art. nr.	NRF nr.	DN	d, ø [mm]	R ["]	L [cm]	H [cm]	SW [mm]
620.300.00.1	2473625	12 / 10	16	3/8"	6,1	2,8	18
620.310.00.1	2473633	12 / 15	16	1/2"	6,1	2,8	22
620.320.00.1	2473641	12 / 20	16	3/4"	6,5	3,2	27
620.301.00.1	2472088	15 / 10	20	3/8"	6,1	2,8	18
620.311.00.1	2473634	15	20	1/2"	6,4	3,1	22
620.321.00.1	2473642	15 / 20	20	3/4"	6,5	3,2	27
620.308.00.1	2472069	15 / 25	20	1"	6,4	3,1	34
620.302.00.1	2473626	20 / 15	25	1/2"	6,4	3,1	22
620.312.00.1	2473635	20	25	3/4"	6,8	3,5	27
620.322.00.1	2473643	20 / 25	25	1"	6,6	3,3	34
620.309.00.1	2472071	25 / 20	32	3/4"	7,5	3,9	27
620.303.00.1	2473627	25	32	1"	7,5	3,9	34
620.313.00.1	2473636	25 / 32	32	1 1/4"	7,2	3,6	43
620.304.00.1	2473628	32 / 25	40	1"	7,4	3,8	47
620.314.00.1	2473637	32	40	1 1/4"	7,4	3,8	47
620.324.00.1	2473644	32 / 40	40	1 1/2"	7,3	3,7	49
620.305.00.1	2473629	40	50	1 1/2"	10	4,1	59
620.315.00.1	2473638	40 / 50	50	2"	10,4	4,4	60
620.306.00.1	2473631	50	63	2"	11	4,7	74
620.316.00.1	2473639	50 / 65	63	2 1/2"	11,3	4,9	76
620.307.00.1	2473632	65	75	2 1/2"	11,4	5	86

Geberit FlowFit-overgang med utvendig gjenge, syrefast

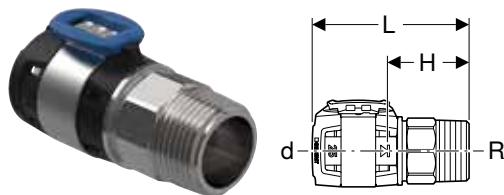

click & scan

Art. nr.	NRF nr.	DN	d, ø [mm]	R ["]	L [cm]	H [cm]	SW [mm]
619.700.00.1	2473645	15	20	1/2"	6,4	3,1	22
619.701.00.1	2473646	20	25	3/4"	6,8	3,5	27
619.702.00.1	2473647	25	32	1"	7,5	3,9	34
619.703.00.1	2473648	32	40	1 1/4"	7,4	3,8	47
619.704.00.1	2473649	40	50	1 1/2"	10	4,1	59
619.705.00.1	2473651	50	63	2"	11	4,7	74
619.706.00.1	2473652	65	75	2 1/2"	11,4	5	86

Geberit FlowFit overgangsstykke med innvendige gjenger

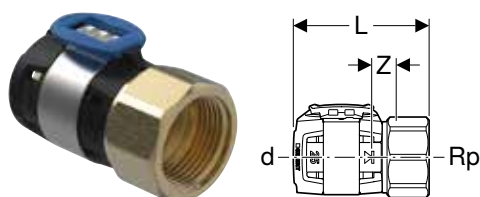

click & scan

Art. nr.	NRF nr.	DN	d, ø [mm]	Rp ["]	L [cm]	Z [cm]	SW [mm]
620.400.00.1	2473653	12 / 10	16	3/8"	5,1	1	22
620.410.00.1	2473661	12 / 15	16	1/2"	5,6	1,3	27
620.420.00.1	2473668	12 / 20	16	3/4"	5,8	1,3	32
620.401.00.1	2472089	15 / 10	20	3/8"	5,3	1,2	22
620.411.00.1	2473662	15	20	1/2"	5,5	1,1	27
620.421.00.1	2473669	15 / 20	20	3/4"	5,8	1,3	32
620.402.00.1	2473654	20	25	3/4"	5,7	1,2	32
620.412.00.1	2473663	20 / 25	25	1"	6,1	1,5	41
620.403.00.1	2473655	25	32	1"	6,4	1,4	41
620.413.00.1	2473664	25 / 32	32	1 1/4"	6,7	1,5	47
620.404.00.1	2473656	32 / 25	40	1"	6,4	1,4	47
620.414.00.1	2473665	32	40	1 1/4"	6,7	1,5	47
620.424.00.1	2473671	32 / 40	40	1 1/2"	6,7	1,5	54
620.405.00.1	2473657	40	50	1 1/2"	9,3	1,7	60
620.415.00.1	2473666	40 / 50	50	2"	9,7	1,8	67
620.406.00.1	2473658	50	63	2"	10,2	1,9	75
620.416.00.1	2473667	50 / 65	63	2 1/2"	10,7	1,9	83
620.407.00.1	2473659	65	75	2 1/2"	10,7	2,5	86

Geberit FlowFit albu 90° med utvendige gjenger

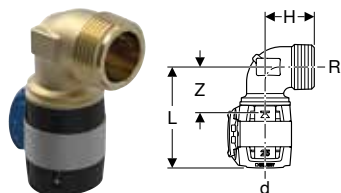

click & scan

Art. nr.	NRF nr.	DN	d, ø [mm]	R ["]	arc [°]	L [cm]	H [cm]	Z [cm]
620.510.00.1	2473439	12 / 15	16	1/2"	90	5,7	2,5	2,4
620.520.00.1	2473441	12 / 20	16	3/4"	90	6	3,1	2,7
620.511.00.1	2473442	15	20	1/2"	90	6,1	2,8	2,8
620.521.00.1	2473443	15 / 20	20	3/4"	90	6	2,7	2,7
620.502.00.1	2473444	20	25	3/4"	90	6	2,9	2,7
620.512.00.1	2473445	20 / 25	25	1"	90	6,3	3,2	3
620.503.00.1	2473446	25	32	1"	90	6,8	3,1	3,2
620.504.00.1	2473447	32	40	1 1/4"	90	7,3	4,2	3,7
620.505.00.1	2473448	40	50	1 1/2"	90	10,4	4,7	4,5
620.506.00.1	2473449	50	63	2"	90	11,7	5,8	5,4

Geberit FlowFit albu 90° med utvendige gjenger, lang

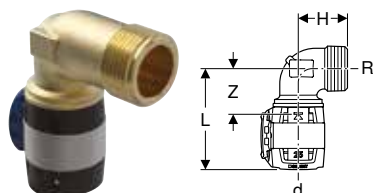

click & scan

Art. nr.	NRF nr.	DN	d, ø [mm]	R ["]	arc [°]	L [cm]	H [cm]	Z [cm]
620.522.00.1	2472004	12 / 15	16	1/2"	90	5,7	3,7	2,4
620.523.00.1	2472006	12 / 20	16	3/4"	90	6	4,5	2,7
620.524.00.1	2472008	15	20	1/2"	90	6,1	3,7	2,8
620.525.00.1	2472011	15 / 20	20	3/4"	90	6	4,5	2,7
620.526.00.1	2472013	20	25	3/4"	90	6	4,5	2,7
620.527.00.1	2472015	20 / 25	25	1"	90	6,3	5,6	3
620.528.00.1	2472044	25	32	1"	90	6,8	5,6	3,2

Geberit FlowFit albu 90° med innvendige gjenger

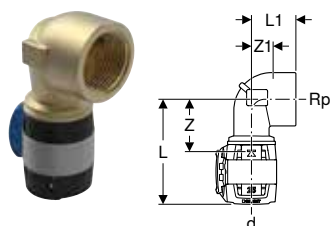

click & scan

Art. nr.	NRF nr.	DN	d, ø [mm]	Rp ["]	arc [°]	L [cm]	L1 [cm]	Z [cm]	Z1 [cm]
620.540.00.1	2473456	12 / 15	16	1/2"	90	6,1	2,2	2,8	0,9
620.550.00.1	2473459	12 / 20	16	3/4"	90	6,3	2,5	3	1,2
620.541.00.1	2473457	15	20	1/2"	90	6,1	2,4	2,8	1,1
620.551.00.1	2473461	15 / 20	20	3/4"	90	6,5	2,6	3,2	1,3
620.532.00.1	2473451	20	25	3/4"	90	6,5	2,8	3,2	1,5
620.542.00.1	2473458	20 / 25	25	1"	90	6,9	3	3,6	1,4
620.533.00.1	2473452	25	32	1"	90	7,4	3,4	3,8	1,8
620.534.00.1	2473453	32	40	1 1/4"	90	8,1	3,7	4,5	2,2
620.535.00.1	2473454	40	50	1 1/2"	90	11,2	4,5	5,3	3
620.536.00.1	2473455	50	63	2"	90	12,8	5,3	6,4	3,5

Overganger og forbindelser, løsbare

Geberit FlowFit union

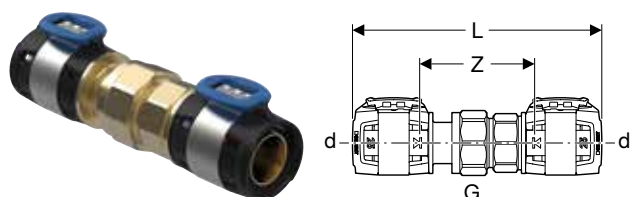

click & scan

Art. nr.	NRF nr.	DN	d, ø [mm]	G ["]	L [cm]	Z [cm]	SW [mm]
620.570.00.1	2473672	12	16	1/2"	11,5	5	24
620.571.00.1	2473673	15	20	1/2"	11,7	5,2	24
620.572.00.1	2473674	20	25	3/4"	12,1	5,6	30
620.573.00.1	2473675	25	32	1"	13,9	6,7	38
620.574.00.1	2473676	32	40	1 1/4"	13,9	6,7	46
620.575.00.1	2473677	40	50	1 1/2"	19,1	7,2	55
620.576.00.1	2473678	50	63	2"	20,5	7,8	67

Geberit FlowFit union med utvendige gjenger

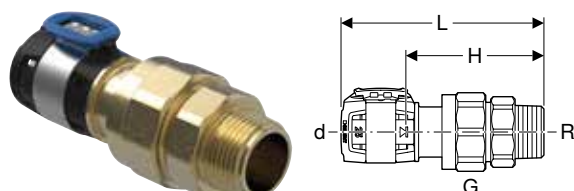

click & scan

Art. nr.	NRF nr.	DN	d, ø [mm]	R ["]	G ["]	L [cm]	H [cm]	SW [mm]
620.580.00.1	2473679	12 / 15	16	1/2"	3/4"	8,7	5,4	30
620.581.00.1	2473681	15	20	1/2"	3/4"	9,3	6	30
620.591.00.1	2473682	15 / 20	20	3/4"	1"	9,4	6,1	30
620.582.00.1	2473683	20	25	3/4"	1"	10,2	6,9	38
620.583.00.1	2473684	25	32	1"	1 1/4"	10,5	6,9	46
620.593.00.1	2473685	25 / 32	32	1 1/4"	1 1/2"	10,8	7,2	46
620.584.00.1	2473686	32	40	1 1/4"	1 1/2"	11,3	7,7	55
620.594.00.1	2473687	32 / 40	40	1 1/2"	1 3/4"	11,3	7,7	55
620.585.00.1	2473688	40	50	1 1/2"	1 3/4"	14,9	9	62
620.595.00.1	2473689	40 / 50	50	2"	2 3/4"	14,9	8,9	67
620.586.00.1	2473691	50	63	2"	2 3/4"	15,3	8,9	89
620.596.00.1	2473692	50 / 65	63	2 1/2"	2 3/4"	15,5	9,2	89

Geberit FlowFit union med innvendige gjenger

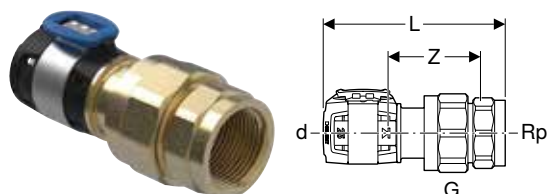

click & scan

Art. nr.	NRF nr.	DN	d, ø [mm]	Rp ["]	G ["]	L [cm]	Z [cm]	SW [mm]
620.600.00.1	2473693	12 / 15	16	1/2"	3/4"	7,9	3,3	30
620.601.00.1	2473694	15	20	1/2"	3/4"	8,5	3,9	30
620.602.00.1	2473695	20	25	3/4"	1"	9,2	4,4	38
620.603.00.1	2473696	25	32	1"	1 1/4"	9,4	4,1	46
620.613.00.1	2473697	25 / 32	32	1 1/4"	1 1/4"	10,6	5,1	46
620.604.00.1	2473698	32	40	1 1/4"	1 1/2"	10,9	5,4	55
620.614.00.1	2473699	32	40	1 1/2"	1 1/2"	11,2	5,6	55
620.605.00.1	2473701	40	50	1 1/2"	1 1/2"	13,8	5,9	55
620.615.00.1	2473702	40 / 50	50	2"	2"	14,9	6,6	67
620.606.00.1	2473703	50	63	2"	2 3/4"	13,3	4,3	89

Geberit FlowFit overgangsstykke med unionmutter

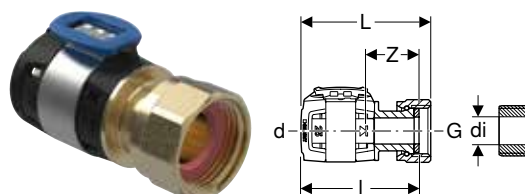

click & scan

Art. nr.	NRF nr.	DN	d, ø [mm]	G ["]	di, ø [mm]	L [cm]	l [cm]	Z [cm]	SW [mm]
620.620.00.1	2473704	12	16	3/8"	9	6,2	5,5	2,2	20
620.630.00.1	2473705	12 / 15	16	1/2"	11	6,4	5,7	2,4	24
620.640.00.1	2473706	12 / 20	16	3/4"	17	5,9	5,2	1,9	30
620.650.00.1	2473707	12 / 25	16	1"	21	6,2	5,4	2,1	38
620.621.00.1	2473708	15 / 12	20	3/8"	9	6,2	5,5	2,2	20
620.631.00.1	2473709	15	20	1/2"	11	6,4	5,7	2,4	24
620.641.00.1	2473711	15 / 20	20	3/4"	16	6,5	5,8	2,5	30
620.651.00.1	2473712	15 / 25	20	1"	21	6,3	5,5	2,2	38
620.672.00.1	2473713	15 / 30	20	1 1/8"	23	6,4	5,5	2,2	41
620.661.00.1	2473714	15 / 32	20	1 1/4"	27	6,6	5,6	2,3	46
620.671.00.1	2473715	15 / 40	20	1 1/2"	32	6,2	5	1,7	55
620.622.00.1	2473716	20 / 15	25	1/2"	11	6,4	5,7	2,4	24
620.632.00.1	2473717	20	25	3/4"	15	6,5	5,8	2,5	30
620.642.00.1	2473718	20 / 25	25	1"	20	7,3	6,3	3	38
620.652.00.1	2473719	20 / 32	25	1 1/4"	27	6,8	5,8	2,5	46
620.662.00.1	2473721	20 / 40	25	1 1/2"	32	7,1	5,9	2,6	55
620.673.00.1	2473722	20 / 50	25	2"	42	6,3	5	1,7	67
620.623.00.1	2473723	25 / 20	32	3/4"	16	7	6,3	2,7	30
620.633.00.1	2473724	25	32	1"	20	7,8	6,8	3,2	38
620.643.00.1	2473725	25 / 32	32	1 1/4"	27	7,4	6,4	2,8	46
620.653.00.1	2473726	25 / 40	32	1 1/2"	32	7,6	6,4	2,8	55
620.663.00.1	2473727	25 / 50	32	2"	42	7,5	6,2	2,6	67
620.674.00.1	2472111	N 32 / 25	40	1"	20	7,8	6,8	3,2	38
620.624.00.1	2473728	32	40	1 1/4"	27	7,9	6,9	3,3	46
620.634.00.1	2473729	32	40	1 1/2"	33	8	6,9	3,3	55
620.664.00.1	2472098	N 32 / 40	40	1 3/4"	33	8,9	7,6	4	62
620.644.00.1	2473731	32 / 50	40	2"	42	7,8	6,5	2,9	67
620.654.00.1	2473732	32 / 65	40	2 1/4"	42	7,7	6,3	2,7	74
620.625.00.1	2473733	40	50	1 1/2"	33	10,6	9,5	3,6	55
620.635.00.1	2473734	40	50	1 3/4"	33	11,5	10,2	4,3	62
620.645.00.1	2473735	40 / 50	50	2"	42	11	9,9	3,9	67
620.655.00.1	2473736	40 / 50	50	2 1/4"	42	10,8	9,4	3,5	74
620.665.00.1	2473737	40 / 50	50	2 3/8"	52	10,9	9,4	3,5	78
620.695.00.1	2472099	N 40 / 65	50	2 1/2"	54	10,9	9,7	3,8	83
620.675.00.1	2473738	40 / 65	50	2 3/4"	62	10,7	9,1	3,2	89
620.626.00.1	2473739	50 / 50	63	2"	42	11,5	10,4	4	67
620.636.00.1	2473741	50 / 50	63	2 3/8"	52	11,6	10,5	4,1	78
620.646.00.1	2473742	50 / 65	63	2 1/2"	54	11,8	10,2	3,9	83
620.656.00.1	2473743	50 / 65	63	2 3/4"	62	11,5	9,9	3,6	89

N: Ny, kan leveres fra april 2024

Geberit FlowFit albue 90° med unionmutter

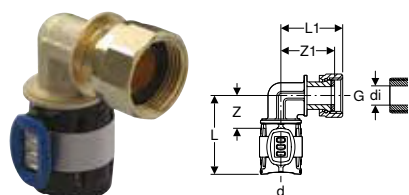

click & scan

Art. nr.	NRF nr.	DN	d, ø [mm]	G ["]	di, ø [mm]	L [cm]	L1 [cm]	Z [cm]	Z1 [cm]	SW [mm]
620.685.00.1	2472059	12	16	3/8"	9	5,4	3,7	3,6	3,1	22
620.686.00.1	2472061	12 / 15	16	1/2"	11	5,6	4	3,6	3,3	24
620.688.00.1	2472062	15	20	1/2"	11	5,6	4,2	3,5	3,5	24
620.689.00.1	2472064	15 / 20	20	3/4"	16	5,8	3,2	3,5	3,6	30
620.693.00.1	2472072	20	25	3/4"	15	5,9	4,5	3,5	3,8	30
620.694.00.1	2472073	20 / 25	25	1"	20	6,3	5,2	3,5	4,3	38

Geberit FlowFit overgangsstykke med klemringskobling

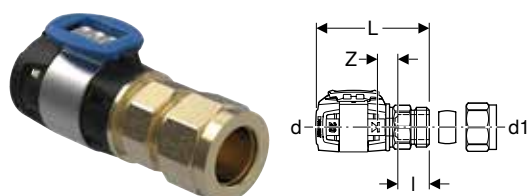

click & scan

Art. nr.	NRF nr.	DN	d, ø [mm]	d1, ø [mm]	L [cm]	l [cm]	Z [cm]
620.680.00.1	2472091	12 / 10	16	12	5,8	1,7	0,8
620.683.00.1	2472066	12 / 10	16	14	5,8	1,7	0,8
620.690.00.1	2473744	12	16	15	5,8	1,6	0,9
620.691.00.1	2472067	12	16	16	5,8	1,6	0,9
620.681.00.1	2473745	15 / 12	20	15	6	1,6	1,1
620.684.00.1	2472068	15	20	18	6	1,6	1,1

Geberit FlowFit albue 90° med klemringskobling

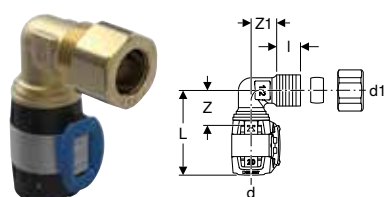

click & scan

Art. nr.	NRF nr.	DN	d, ø [mm]	d1, ø [mm]	arc [°]	L [cm]	l [cm]	Z [cm]	Z1 [cm]	SW [mm]
620.700.00.1	2472092	12 / 10	16	12	90	5,5	0,8	2,2	1,7	24
620.710.00.1	2472094	12	16	15	90	5,5	0,8	2,2	1,7	24
620.701.00.1	2472093	15 / 12	20	15	90	5,7	0,8	2,4	1,7	24

Geberit FlowFit overgangsstykke til klemringskobling til kobberør

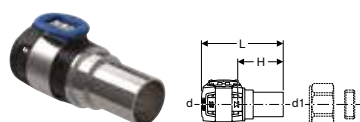

click & scan

Art. nr.	NRF nr.	DN	d, ø [mm]	d1, ø [mm]	L [cm]	H [cm]
620.720.00.1	2473746	12	16	15	7	3,7
620.721.00.1	2473747	15 / 12	20	15	7	3,7
620.722.00.1	2473748	20	25	22	7,4	4,1

i • Utelukkende egnet for klemringskoblinger

Geberit FlowFit overgangsstykke med skrukobling for PEX-rør

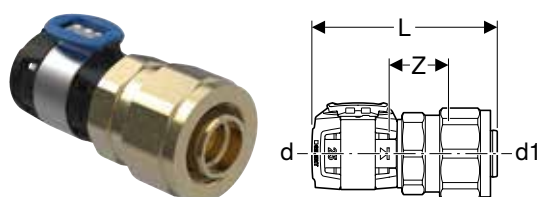

click & scan

Art. nr.	NRF nr.	DN	d, ø [mm]	G ["]	d1, ø [mm]	s1 [mm]	L [cm]	Z [cm]	PN [bar]
620.730.00.1	2472095	12	16	3/4"	16	1,5	7,8	3,1	6
620.731.00.1	2472096	15	20	3/4"	20	1,9	7,8	3,1	6
620.732.00.1	2472097	20	25	1"	25	2,3	8	3,3	6

Geberit FlowFit flens PN6, med pressenhet

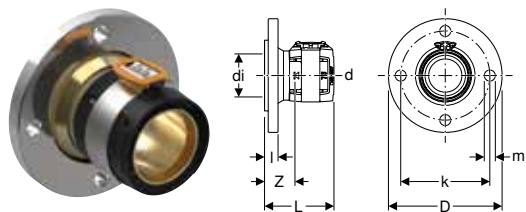

click & scan

Art. nr.	NRF nr.	DN	d, ø [mm]	di, ø [mm]	D [cm]	k [mm]	m [mm]	L [cm]	l [cm]	Z [cm]	n [pc.]	PN [bar]
619.616.00.1	2473749	65	75	70	16	130	14	11,3	2,4	5	4	6

Geberit FlowFit flens PN10/16, med pressenhet

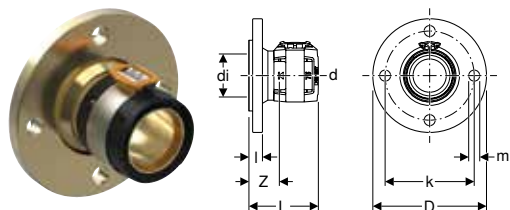

click & scan

Art. nr.	NRF nr.	DN	d, ø [mm]	di, ø [mm]	D [cm]	k [mm]	m [mm]	L [cm]	l [cm]	Z [cm]	n [pc.]	PN [bar]
619.617.00.1	2473751	65	75	70	18,5	145	18	11,3	2,4	5	4	10 / 16

Endedeksler

Geberit FlowFit endeplugg til rør

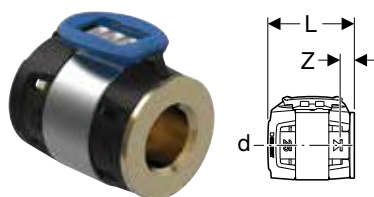

click & scan

Art. nr.	NRF nr.	DN	d, ø [mm]	L [cm]	Z [cm]
620.740.00.1	2473752	12	16	3,9	0,6
620.741.00.1	2473753	15	20	3,9	0,6
620.742.00.1	2473754	20	25	3,9	0,6

Tilkoblinger

Geberit FlowFit, tilkoblingsvinkel 90°

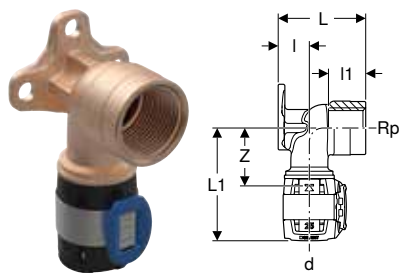

click & scan

Art. nr.	NRF nr.	DN	d, ø [mm]	Rp ["]	arc [°]	L1 [cm]	I [cm]	I1 [cm]	Z [cm]
L / Lengde: 3,6 cm									
620.750.00.1	2473463	12	16	3/8"	90	6	1,9	1,3	2,7
620.760.00.1	2473464	12	16	1/2"	90	6	1,9	1,3	2,8
620.761.00.1	2473465	15	20	1/2"	90	6,3	1,9	1,3	3,1
L / Lengde: 5,2 cm									
620.810.00.1	2473466	12	16	1/2"	90	6	1,9	1,5	2,7
620.811.00.1	2473467	15	20	1/2"	90	6	1,9	1,7	3,1
620.821.00.1	2473468	15	20	3/4"	90	6,3	1,9	1,9	3
620.802.00.1	2473462	20	25	3/4"	90	6,7	1,9	1,9	3,4
L / Lengde: 7,8 cm									
620.770.00.1	2473469	12	16	1/2"	90	6,8	1,9	3	3,5
620.771.00.1	2473471	15	20	1/2"	90	7,3	1,9	3	4

Fordeler med gjengestuss

Geberit fordeler med gjenge og gjenge for fordeler til eurokonus

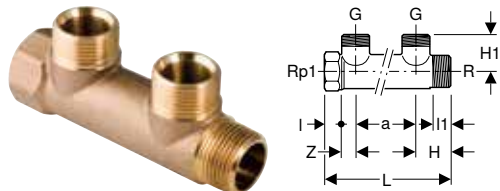

click & scan

Art. nr.	NRF nr.	DN	R ["]	G ["]	Rp1 ["]	a [cm]	L [cm]	I [cm]	I1 [cm]	H [cm]	H1 [cm]	Z [cm]	Antall avløp
602.422.00.1	2472903	20 / 15 / 20	3/4"	3/4"	3/4"	5	10,9	1,5	1,5	3,2	3,2	1,3	2
602.423.00.1	2472904	20 / 15 / 20	3/4"	3/4"	3/4"	5	16	1,5	1,5	3,2	3,2	1,3	3



- Feste med isolert Geberit brakett (art. nr. 601.853.26.1)

Overgangsstykker og tilkoblinger for varmelement, løsbare

Geberit FlowFit overgangsstykke med skrukobling for PEX-rør

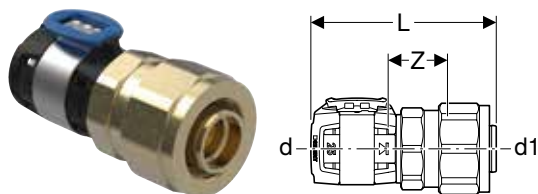

click & scan

Art. nr.	NRF nr.	DN	d, ø [mm]	G ["]	d1, ø [mm]	s1 [mm]	L [cm]	Z [cm]	PN [bar]
620.730.00.1	2472095	12	16	3/4"	16	1,5	7,8	3,1	6
620.731.00.1	2472096	15	20	3/4"	20	1,9	7,8	3,1	6
620.732.00.1	2472097	20	25	1"	25	2,3	8	3,3	6

Tilbehør

Beskyttelse for rør og fittings

Geberit beskyttelsestape

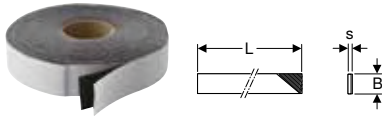

click & scan

Art. nr.	NRF nr.	s [mm]	L [m]	B [cm]
601.813.00.1	2472901	1	12,5	3
601.815.00.1	2472902	1	12,5	5



- Sett på etter trykkontroll

Klammer for rør

Geberit sett for fastpunkt

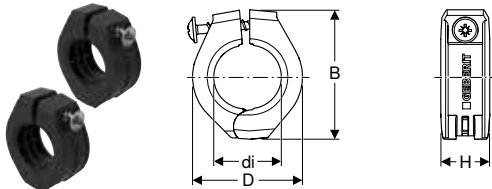

click & scan

Art. nr.	NRF nr.	di, ø [mm]	D [cm]	B [cm]	H [cm]
619.730.00.1	2472024	16	3,1	4	1,9
619.731.00.1	2472025	20	3,5	4,4	1,9
619.732.00.1	2473755	25	4	4,9	1,9
619.733.00.1	2473756	32	4,7	5,6	1,9
619.734.00.1	2473757	40	5,6	6,5	1,9
619.735.00.1	2473758	50	6,6	7,8	2,2
619.736.00.1	2473759	63	8	9,1	2,2
619.737.00.1	2473761	75	9,2	10,3	2,2

Geberit klammerinnlegg

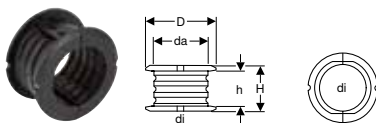

click & scan

Art. nr.	NRF nr.	da [mm]	di, ø [mm]	D [cm]	H [cm]	h [cm]
603.702.00.1	2472753	32	25 / 26	3,4	3,2	2,5
604.702.00.1	2472755	40	32	4,9	3,2	2,5
605.702.00.1	2472757	50	40	5,7	3,3	2,5
606.702.00.1	2472759	63	50	7,6	3,4	2,5
607.702.00.1	2472761	75	63	9,1	4,8	3
608.702.00.1	2472762	90	75	10,7	5	3

Geberit bæreskall forsinket og lakkert

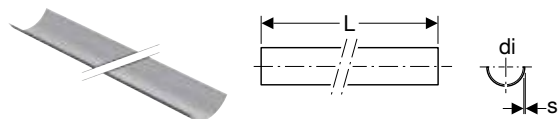

click & scan

Art. nr.	Farge / overflate	DN	di, ø [mm]	s [mm]	L [m]
360.850.00.1	Lakkert	40	40	0,75	3
361.850.00.1	Lakkert	50	50	0,75	3
364.850.00.1	Lakkert	60	63	0,75	3
365.850.00.1	Lakkert	70	75	0,75	3
388.126.00.1	Lakkert		20	0,75	3
388.128.00.1	Lakkert		32	0,75	3
388.127.00.1	Lakkert		25-26	0,75	3

Geberit bunnplate rektangulær, to hull, med gjenget rørmuffe M8/M10

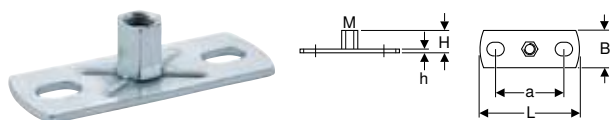

click & scan

Art. nr.	NRF nr.	M [mm]	a [cm]	L [cm]	B [cm]	H [cm]	h [cm]
362.848.26.1	2290373	8 / 10	5,4	8	3	1,9	0,3

Geberit bunnplate rektangulær, to hull, med gjenget rørmuffe M10 / G 1/2"

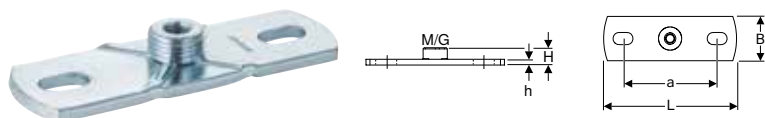

click & scan

Art. nr.	NRF nr.	G ["]	M [mm]	a [cm]	L [cm]	B [cm]	H [cm]	h [cm]
362.851.26.1	2290374	1/2"	10	8,5	12	4	1,5	0,5

Forbruksmateriell

Geberit lekkasjesøkingsspray



click & scan

Art. nr.	Innhold [ml]
690.942.00.1	400





Rørarmaturer

Kuleventiler	162
Med FlowFit pressforbindelser	162
Med Mepla pressetilkoblinger	162
Med Mapress pressetilkoblinger.....	163
Tilbakeslagsventiler	165
Med Mapress pressetilkoblinger.....	165



Kuleventiler Med FlowFit pressforbindelser

Geberit FlowFit kuleventil med betjeningshendel

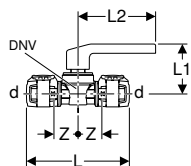

click & scan

Art. nr.	NRF nr.	DN	DNV	d, ø [mm]	L [cm]	L1 [cm]	L2 [cm]	Z [cm]	PN [bar]
619.850.00.1	2472036	12	8	16	11,9	5,8	9,2	2,7	10
619.851.00.1	2472037	15	15	20	12,1	5,9	9,2	2,8	10
619.852.00.1	2472038	20	15	25	12,2	5,9	9,2	2,8	10
619.853.00.1	2472039	25	20	32	13,4	6,2	9,2	3,1	10
619.854.00.1	2472041	32	25	40	14,4	7,1	12,4	3,6	10
619.855.00.1	2472042	40	32	50	20,9	7,6	12,4	4,5	10

Med Mepla presstilkoblinger

Geberit Mepla kuleventil med betjeningshendel

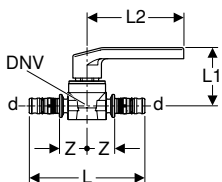

click & scan

Art. nr.	NRF nr.	DN	DNV	d, ø [mm]	L [cm]	L1 [cm]	L2 [cm]	Z [cm]	PN [bar]
611.061.00.2	2472711	12	8	16	10,1	6	9,5	2,4	10
612.061.00.2	2472712	15	15	20	10,6	6	9,5	2,5	10
613.061.00.2	2472713	20	15	26	11,6	6	9,5	2,5	10
614.061.00.2	2472714	25	20	32	11,8	6,5	9,5	3	10
615.061.00.2		32	25	40	13,9	7,1	12,4	3,5	10
616.061.00.2		40	32	50	15,9	7,7	12,4	3,9	10

Geberit Mepla kuleventil med betjeningshendel

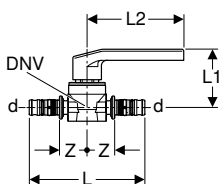

click & scan

Art. nr.	NRF nr.	DN	DNV	d, ø [mm]	L [cm]	L1 [cm]	L2 [cm]	Z [cm]	PN [bar]
601.020.00.2	2472027	12	8	16	10,1	6	9,5	2,4	10
602.020.00.2	2472028	15	15	20	12	6	9,5	2,5	10
603.020.00.2	2472029	20	15	26	12	6	9,5	2,5	10
604.020.00.2	2472031	25	20	32	12	6,5	9,5	3	10
605.020.00.2	2472032	32	25	40	13,9	7,1	12,4	3,5	10
606.020.00.2	2472033	40	32	50	15,9	7,7	12,4	3,9	10

Geberit Mepla kuleventil med utvendige gjenger og betjeningshendel

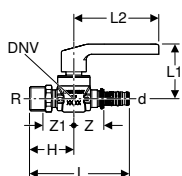

click & scan

Art. nr.	NRF nr.	DN	DNV	DN1	d, ø [mm]	R ["]	L [cm]	L1 [cm]	L2 [cm]	H [cm]	Z [cm]	Z1 [cm]	PN [bar]
602.023.00.2	2472034	15	15	20	20	3/4"	10,8	6	9,2	4,8	3,2	3,4	10
603.023.00.2	2472035	20	15	20	26	3/4"	10,8	6	9,2	4,8	2,7	3,4	10

Med Mapress presstilkoblinger

Geberit Mapress Syrefast Stål kuleventil med betjeningshendel

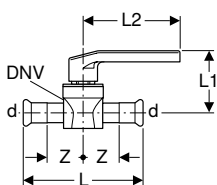

click & scan

Art. nr.	NRF nr.	DN	DNV	d, ø [mm]	L [cm]	L1 [cm]	L2 [cm]	Z [cm]	PN [bar]
94952	1950053	12	15	15	10,4	5,9	9,2	3,2	16
94953	1950054	15	15	18	10,4	5,9	9,2	3,2	16
94954	1950055	20	20	22	11,6	6,2	9,2	3,7	16
94955	1950056	25	25	28	13,4	7,1	12,4	4,4	16
94956	1950057	32	32	35	15,4	7,6	12,4	5,1	16
94957	1950058	40	40	42	17,7	8,3	14,7	5,9	16
94958	1950059	50	50	54	20,6	9	14,7	6,8	16

Geberit Mapress kuleventil teknisk vann, med betjeningshendel

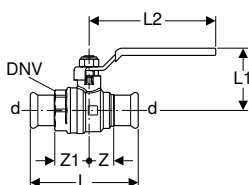

click & scan

Art. nr.	NRF nr.	DN	DNV	d, ø [mm]	L [cm]	L1 [cm]	L2 [cm]	Z [cm]	Z1 [cm]	PN [bar]
94922	1950191	12	15	15	7,7	4,4	8,5	1,7	2,4	16
94923	1950192	15	15	18	8	4,4	8,5	1,7	2,4	16
94924	1950193	20	20	22	8,9	5,2	10,6	2,1	2,9	16
94925	1950194	25	25	28	9,6	5,6	10,6	2,4	3,1	16
94926	1950195	32	32	35	10,9	6,1	10,6	2,7	3,4	16
94927	1950196	40	40	42	14,1	7,9	15,5	3,6	4,5	16
94928	1950197	50	50	54	15,7	9,4	17,5	3,9	4,8	16

Geberit Mapress kuleventil teknisk vann, med høy betjeningshendel

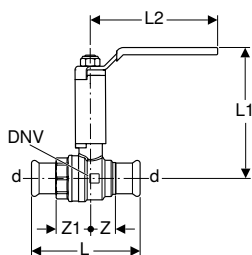

click & scan

Art. nr.	NRF nr.	DN	DNV	d, ø [mm]	L [cm]	L1 [cm]	L2 [cm]	Z [cm]	Z1 [cm]	PN [bar]
94962	1950093	12	15	15	7,7	10,4	8,5	1,7	2,4	16
94963	1950094	15	15	18	8	10,4	8,5	1,7	2,4	16
94964	1950095	20	20	22	8,9	11,7	10,6	2,1	2,9	16
94965	1950096	25	25	28	9,6	12,1	10,6	2,4	3,1	16
94966	1950097	32	32	35	10,9	12,6	10,6	2,7	3,4	16
94967	1950098	40	40	42	14,1	14	15	3,6	4,5	16
94968	1950099	50	50	54	15,7	15,5	17	3,9	4,8	16

Geberit forlengersett for kuleventil teknisk vann

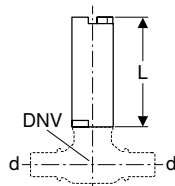

click & scan

Art. nr.	DNV	d, ø [mm]	L [cm]
94935	15	18	6
94936	20 / 25 / 32	22 / 28 / 35	6,5
94937	40	42	6,5
94938	50	54	6,5

Geberit Mapress Syrefast Stål kuleventil med betjeningshendel, flenset

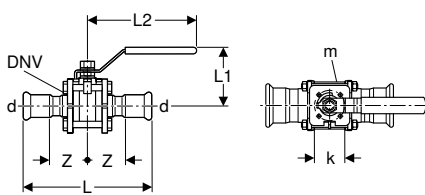

click & scan

Art. nr.	DN	DNV	d, ø [mm]	k [mm]	m [mm]	L [cm]	L1 [cm]	L2 [cm]	Z [cm]	PN [bar]
92100	12	15	15			12,2	5,5	10,5	4,1	40
92101	15	15	18			12,2	5,5	10,5	4,1	40
92102	20	20	22			13,3	6,1	10,5	4,6	40
92103	25	25	28			14,2	7,2	13	4,8	16
92104	32	32	35			17	8	13	5,9	16
92105	40	40	42			19,4	9,1	16	6,7	16
92106	50	50	54			22,1	10,2	16	7,5	16
92107	65	65	76,1	70	9	29,1	14	22,5	9,3	16
92108	80	80	88,9	70	9	33,3	15	36	10,6	16
92109	100	100	108	102	11	41,2	19,2	50	13,1	16

Geberit Mapress CuNiFe kuleventil med betjeningshendel, flenset

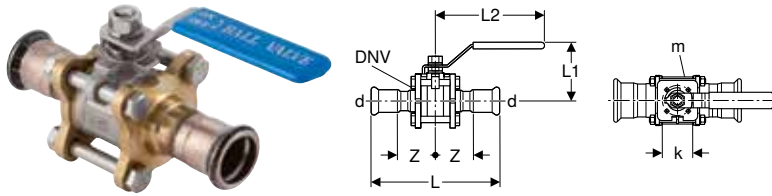

click & scan

Art. nr.	DN	DNV	d, ø [mm]	k [mm]	m [mm]	L [cm]	L1 [cm]	L2 [cm]	Z [cm]	PN [bar]
92120	12	15	15			12,2	5,5	10,5	4,1	13
92122	20	20	22			13,3	6,1	10,5	4,6	13
92123	25	25	28			14,2	7,2	13	4,8	13
92124	32	32	35			17	8	13	5,9	13
92125	40	40	42			19,4	9,1	16	6,7	13
92126	50	50	54			22,1	10,2	16	7,5	13
92127	65	65	76,1	70	9	29,1	14	22,5	9,3	10
92128	80	80	88,9	70	9	33,3	15	36	10,6	10
92129	100	100	108	102	11	41,2	19,2	50	13,1	10

Tilbakeslagsventiler Med Mapress presstilkoblinger

Geberit Mapress Syrefast Stål tilbakeslagsventil flenset

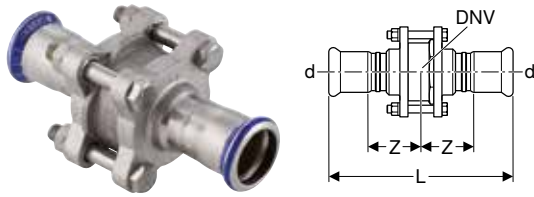

click & scan

Art. nr.	DN	DNV	d, ø [mm]	L [cm]	Z [cm]	PN [bar]
92140	12	15	15	11,1	3,8	40
92142	20	20	22	12	3,9	40
92143	25	25	28	12,6	4	16
92144	32	32	35	14,7	4,8	16
92145	40	40	42	16,7	5,3	16
92146	50	50	54	18,5	5,8	16
92147	65	65	76,1	25,5	7,5	16
92148	80	80	88,9	28,5	8,3	16
92149	100	100	108	34,6	9,8	16

Geberit Mapress CuNiFe tilbakeslagsventil flenset

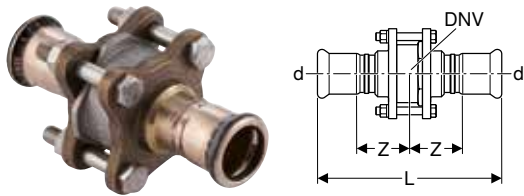

click & scan

Art. nr.	DN	DNV	d, ø [mm]	L [cm]	Z [cm]	PN [bar]
92150	12	15	15	11,1	3,8	13
92152	20	20	22	12	3,9	13
92153	25	25	28	12,6	4	13
92154	32	32	35	14,7	4,8	13
92155	40	40	42	16,7	5,3	13
92156	50	50	54	18,5	5,8	13
92157	65	65	76,1	25,5	7,5	10
92158	80	80	88,9	28,5	8,3	10
92159	100	100	108	34,6	9,8	10



Geberit hygienesystem

Hygienespylerenheter	168
Tilbehør	168
Deksler og dekkplater	168
Sisterner og toalett-styringer med hygienespyling	169
Hygienemoduler	169
Tilbehør til sisterner og toalett-styringer med hygienespyling	169
Nettdel.....	169
Nettverkskomponenter	171
Tilbehør til sisterner og toalett-styringer med hygienespyling	172
Sortimentsoversikt – Geberit Connect-produkter med hygienespyling	172



Hygienespylerenheter

Geberit HS01 hygienespyling

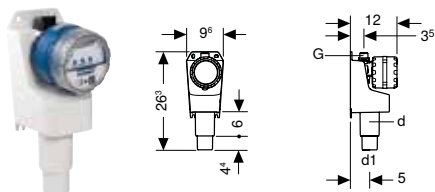

click & scan

Art. nr.	DN	d, ø [mm]	G ["]	d1, ø [mm]	H [cm]	T [cm]	Tilkobling
616.290.00.1	40	50	1/2"	40	26,3	12	1 vanntilkoplinge

Geberit HS01 hygienespyling, styreenhet

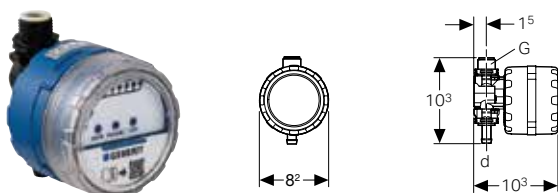

click & scan

Art. nr.	d, ø [mm]	G ["]	H [cm]	T [cm]	Tilkobling
616.291.00.1	10	1/2"	10,3	10,3	1 vanntilkoplinge

Tilbehør

Deksler og dekkplater

Geberit deksel til hygieneskylling

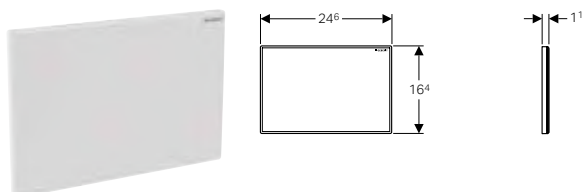

click & scan

Art. nr.	Farge / overflate	Materiale
616.222.11.1	Alpehvit	Plast
616.222.21.1	Blankforkrommet	Plast
616.222.46.1	Matt forkrommet	Plast
241.595.00.1	Syrefast stål børstet	Syrefast stål

Sisterner og toalett-styringer med hygienespyling

Hygienemoduler

Geberit HS05 hygienespyling for Sigma innbyggings sisterner 12 cm, nettdrift



click & scan

Art. nr.	NRF nr.	Inngangsstrøm
116.109.00.6	6166786	≤ 4

Bestilles i tillegg

- Betjeningsplate
- Geberit Power & Connect-boks
- Geberit strømforsyning for Power & Connect-boks

Kan kombineres med

- Geberit installasjonssett med strømadapter, til WC-betjening med elektronisk aktivering av skyll, 12 V → s. 170
- Geberit sett Power & Connect-boks og strømforsyning for element for vegghengt toalett → s. 171

Geberit HS05 hygienespyling for Sigma innbyggings sisterner 12 cm, batteridrift



click & scan

Art. nr.	NRF nr.	Inngangsstrøm
116.110.00.6	6166787	≤ 4

Bestilles i tillegg

- Betjeningsplate

Tilbehør til sisterner og toalett-styringer med hygienespyling

Nettdel

Sett strømforsyning 230 V / 12 V / 50 Hz, med 1,8 m strømkabel, til el-boks

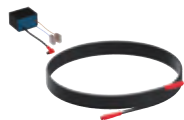

click & scan

Art. nr.	NRF nr.
115.335.00.1	6166679

Tilbehør

- Byggesett for innfelt omformer, for Geberit DuoFresh modul
- Geberit kombinasjonskoplingsboks

Geberit installasjonssett med strømadapter, til WC-betjening med elektronisk aktivering av skylld, 12 V

click & scan

Art. nr.	NRF nr.
115.861.00.6	6166398

Kan kombineres med

- Geberit HS05 hygienespyling for Sigma innbyggingssisterne 12 cm, nettdrift → s. 169
- Geberit WC-skyllesystem med elektronisk aktivering av skylld, nettdrift, for Sigma innbyggingssisterne 12 cm, dobbeltskylld, med Sigma10 betjeningsplate automatisk/berøringsfri
- Geberit WC-skyllesystem med elektronisk aktivering av skylld, nettdrift, for Sigma innbyggingssisterne 12 cm, dobbeltskylld, med Sigma10 betjeningsplate automatisk/berøringsfri, kan skrues
- Geberit WC-skyllesystem med elektronisk aktivering av skylld, nettdrift, for Sigma innbyggingssisterne 12 cm, dobbeltskylld, med Sigma10 betjeningsplate automatisk/berøringsfri/manuell
- Geberit WC-skyllesystem med elektronisk aktivering av skylld, nettdrift, for Sigma innbyggingssisterne 12 cm, dobbeltskylld, med Sigma80 betjeningsplate berøringsfri
- Geberit WC-skyllesystem med elektronisk aktivering av skylld, nettdrift, for Sigma innbyggingssisterne 12 cm, enkeltskylld, med Sigma10 betjeningsplate, til nedfellbart håndtak, radio
- Geberit WC-skyllesystem med elektronisk aktivering av skylld, nettdrift, for Sigma innbyggingssisterne 12 cm, enkeltskylld, med Sigma10 betjeningsplate, til nedfellbart håndtak, manuell
- Geberit WC skyllesystem med elektronisk aktivering av skylld, nettdrift, for Sigma innbyggingssisterne 12 cm, dobbeltskylld, for ekstern knapp
- Geberit WC skyllesystem med elektronisk aktivering av skylld, nettdrift, for Omega innbyggingssisterne 12 cm, dobbeltskylld, for ekstern knapp
- Geberit WC skyllesystem med elektronisk aktivering av skylld, nettdrift, for Sigma innbyggingssisterne 12 cm, dobbeltskylld, for fjernstyringsknapp
- Geberit WC skyllesystem med elektronisk aktivering av skylld, nettdrift, for Sigma innbyggingssisterne 12 cm, dobbeltskylld, med type 10 infrarødknapp
- Geberit WC skyllesystem med elektronisk aktivering av skylld, nettdrift, for Omega innbyggingssisterne 12 cm, dobbeltskylld, med type 10 infrarødknapp

Nettverkskomponenter

Geberit sett Power & Connect-boks og strømforsyning for element for vegghengt toalett



click & scan

Art. nr.	NRF nr.
116.098.00.1	6166397

Kan kombineres med

- Geberit WC-skyllesystem med elektronisk aktivering av skyll, nettdrift, for Sigma innbyggingssisterne 12 cm, dobbeltskyll, med Sigma80 betjeningsplate berøringsfri
- Geberit WC-skyllesystem med elektronisk aktivering av skyll, nettdrift, for Sigma innbyggingssisterne 12 cm, dobbeltskyll, med Sigma10 betjeningsplate automatisk/berøringsfri/manuell
- Geberit WC-skyllesystem med elektronisk aktivering av skyll, nettdrift, for Sigma innbyggingssisterne 12 cm, dobbeltskyll, med Sigma10 betjeningsplate automatisk/berøringsfri, kan skrues
- Geberit WC-skyllesystem med elektronisk aktivering av skyll, nettdrift, for Sigma innbyggingssisterne 12 cm, dobbeltskyll, med Sigma10 betjeningsplate automatisk/berøringsfri
- Geberit WC skyllesystem med elektronisk aktivering av skyll, nettdrift, for Sigma innbyggingssisterne 12 cm, dobbeltskyll, for ekstern knapp
- Geberit WC skyllesystem med elektronisk aktivering av skyll, nettdrift, for Omega innbyggingssisterne 12 cm, dobbeltskyll, for ekstern knapp
- Geberit WC-skyllesystem med elektronisk aktivering av skyll, nettdrift, for Sigma innbyggingssisterne 12 cm, enkeltskyll, med Sigma10 betjeningsplate, til nedfellbart håndtak, manuell
- Geberit WC skyllesystem med elektronisk aktivering av skyll, nettdrift, for Sigma innbyggingssisterne 12 cm, dobbeltskyll, med type 10 infrarødknapp
- Geberit WC skyllesystem med elektronisk aktivering av skyll, nettdrift, for Omega innbyggingssisterne 12 cm, dobbeltskyll, med type 10 infrarødknapp
- Geberit WC skyllesystem med elektronisk aktivering av skyll, nettdrift, for Sigma innbyggingssisterne 12 cm, dobbeltskyll, for fjernstyringsknapp
- Geberit WC-skyllesystem med elektronisk aktivering av skyll, nettdrift, for Sigma innbyggingssisterne 12 cm, enkeltskyll, med Sigma10 betjeningsplate, til nedfellbart håndtak, radio
- Geberit HS05 hygienespyling for Sigma innbyggingssisterne 12 cm, nettdrift → s. 169
- Geberit DuoFresh-modul med automatisk start og innstikk til Geberit DuoFresh Stick, til Sigma innbyggingssisterne 12 cm
- Geberit DuoFresh modul med manuell start og innstikk til Geberit DuoFresh Stick, til Sigma innbyggingssisterne 12 cm



Tilbehør til sisterner og toalett-styringer med hygienespyling

Sortimentsoversikt – Geberit Connect-produkter med hygienespyling

Geberit Norge, oktober 2023

I tillegg til grunnfunksjonen gir følgende produkter mulighet til å programmere intervallskyllinger og kan derfor sikre regelmessig vannutskiftning

For WC-styring med elektronisk aktivering av skylling

	For nettdrift, for Geberit Sigma innbyggingssisterner 12 cm	Katalog "xxx", ab Seite xyz
	For nettdrift, for Geberit Sigma innbyggingssisterner 8 cm	Katalog "xxx", ab Seite xyz
	Ikke egnet for Geberit Omega innbyggingssisterner 12 cm	Katalog "xxx", ab Seite xyz
	For batteridrift, for Geberit Sigma innbyggingssisterner 12 cm	Katalog "xxx", ab Seite xyz

Urinaler med integrert styring

	Med integrert urinalstyring	Katalog "xxx", ab Seite xyz
--	-----------------------------	-----------------------------

Urinalstyring, skjult montasje

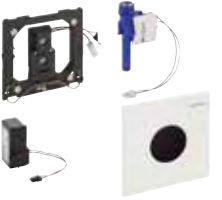
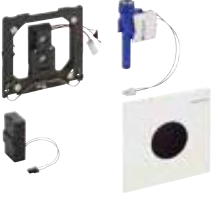
	Med elektronisk aktivering av skyll, nettdrift	Katalog "xxx", ab Seite xyz
	Med elektronisk aktivering av skyll, batteridrift	Katalog "xxx", ab Seite xyz

Urinalstyring utenpåliggende, skjult

	Med elektronisk aktivering av skyll, nettdrift	Katalog "xxx", ab Seite xyz
	Med elektronisk aktivering av skyll, batteridrift	Katalog "xxx", ab Seite xyz

Geberit Norge, oktober 2023

I tillegg til grunnfunksjonen gir følgende produkter mulighet til å programmere intervallskyllinger og kan derfor sikre regelmessig vannskiftning

Servantarmaturer

	<p>Montering av stativ, nettdrift</p>	<p>Katalog "xxx", ab Seite xyz</p>
	<p>Stativmontering, batteridrift</p>	<p>Katalog "xxx", ab Seite xyz</p>
	<p>Stativmontering, generatordrift</p>	<p>Katalog "xxx", ab Seite xyz</p>
	<p>Veggmontasje, nettdrift</p>	<p>Katalog "xxx", ab Seite xyz</p>
	<p>Veggmontasje, batteridrift</p>	<p>Katalog "xxx", ab Seite xyz</p>
	<p>Veggmontasje, generatordrift</p>	<p>Katalog "xxx", ab Seite xyz</p>





Geberit Silent-Pro

Rør	176
Formstykker	177
Bend	177
Grenrør	178
Reduksjoner	181
Stakeluker	182
SuperTube-formstykker	182
Bend	182
Grenrør	183
Forbindelser	184
Muffer	184
Kloforbindelser	184
Overganger til andre materialer	185
Tilbehør	185
Klammer	185
Endedeksler	186
Pakninger	186
Forbruksmateriell	187



Rør

Geberit Silent-Pro rør med muffe

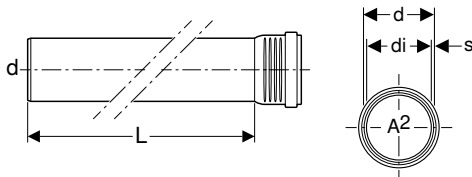

click & scan

Art. nr.	NRF nr.	DN	d, ø [mm]	di, ø [mm]	s [mm]	A ² [cm ²]
L / Lengde: 15 cm						
393.200.14.1	2293701	50	50	44	3	15,2
393.300.14.1	2293702	70	75	67,4	3,8	35,7
393.400.14.1	2293703	90	90	81,4	4,3	52
393.500.14.1	2293704	100	110	101	4,5	80,1
393.600.14.1	2293705	125	125	115	5	103,9
393.700.14.1	2293706	150	160	148	6	172
L / Lengde: 25 cm						
393.201.14.1	2293707	50	50	44	3	15,2
393.301.14.1	2293708	70	75	67,4	3,8	35,7
393.401.14.1	2293709	90	90	81,4	4,3	52
393.501.14.1	2293711	100	110	101	4,5	80,1
393.601.14.1	2293712	125	125	115	5	103,9
393.701.14.1	2293713	150	160	148	6	172
L / Lengde: 50 cm						
393.202.14.1	2293714	50	50	44	3	15,2
393.302.14.1	2293715	70	75	67,4	3,8	35,7
393.402.14.1	2293716	90	90	81,4	4,3	52
393.502.14.1	2293717	100	110	101	4,5	80,1
393.602.14.1	2293718	125	125	115	5	103,9
393.702.14.1	2293719	150	160	148	6	172
L / Lengde: 100 cm						
393.204.14.1	2293721	50	50	44	3	15,2
393.304.14.1	2293722	70	75	67,4	3,8	35,7
393.404.14.1	2293723	90	90	81,4	4,3	52
393.504.14.1	2293724	100	110	101	4,5	80,1
393.604.14.1	2293725	125	125	115	5	103,9
393.704.14.1	2293726	150	160	148	6	172
L / Lengde: 150 cm						
393.205.14.1	2293727	50	50	44	3	15,2
393.305.14.1	2293728	70	75	67,4	3,8	35,7
393.405.14.1	2293729	90	90	81,4	4,3	52
393.505.14.1	2293731	100	110	101	4,5	80,1
393.605.14.1	2293732	125	125	115	5	103,9
393.705.14.1	2293733	150	160	148	6	172
L / Lengde: 200 cm						
393.206.14.1	2293734	50	50	44	3	15,2
393.306.14.1	2293735	70	75	67,4	3,8	35,7
393.406.14.1	2293736	90	90	81,4	4,3	52
393.506.14.1	2293737	100	110	101	4,5	80,1
393.606.14.1	2293738	125	125	115	5	103,9
393.706.14.1	2293739	150	160	148	6	172
L / Lengde: 300 cm						
393.207.14.1	2293741	50	50	44	3	15,2
393.307.14.1	2293742	70	75	67,4	3,8	35,7
393.407.14.1	2293743	90	90	81,4	4,3	52
393.507.14.1	2293744	100	110	101	4,5	80,1
393.607.14.1	2293745	125	125	115	5	103,9
393.707.14.1	2293746	150	160	148	6	172

Formstykker

Bend

Geberit Silent-Pro bend

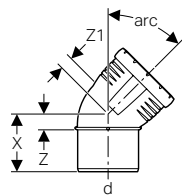

click & scan

Art. nr.	NRF nr.	DN	d, ø [mm]	X [cm]	Z [cm]	Z1 [cm]
arc / Vinkel: 15°						
393.220.14.1	2293747	50	50	5,8	0,7	1,1
393.320.14.1	2293748	70	75	6,5	0,9	1,5
393.420.14.1	2293749	90	90	7,3	1,2	1,6
393.520.14.1	2293751	100	110	8,2	1,4	2
393.620.14.1	2293752	125	125	8,9	1,6	2,4
393.720.14.1	2293753	150	160	9,9	1,9	2,7
arc / Vinkel: 30°						
393.221.14.1	2293754	50	50	6,2	1,1	1
393.321.14.1	2293755	70	75	7,1	1,5	1,5
393.421.14.1	2293756	90	90	7,9	1,8	1,7
393.521.14.1	2293757	100	110	9	2,1	2
393.621.14.1	2293758	125	125	9,8	2,4	2,5
393.721.14.1	2293759	150	160	11	3	2,8
arc / Vinkel: 45°						
393.222.14.1	2293761	50	50	6,5	1,5	1,4
393.322.14.1	2293762	70	75	7,6	2	2,1
393.422.14.1	2293763	90	90	8,5	2,4	2,5
393.522.14.1	2293764	100	110	9,8	3	2,9
393.622.14.1	2293765	125	125	10,7	3,3	3,3
393.722.14.1	2293766	150	160	12,2	4,2	4
arc / Vinkel: 67,5°						
393.223.14.1	2293767	50	50	7,2	2,1	2,1
393.323.14.1	2293768	70	75	8,6	3	3
393.423.14.1	2293769	90	90	9,7	3,6	3,5
393.523.14.1	2293771	100	110	11,2	4,4	4,3
arc / Vinkel: 87,5°						
393.224.14.1	2293772	50	50	7,9	2,8	3
393.324.14.1	2293773	70	75	9,7	4,1	4,2
393.424.14.1	2293774	90	90	11	4,9	4,8
393.524.14.1	2293775	100	110	12,8	6	6
393.624.14.1	2293776	125	125	14,2	6,8	6,7
393.724.14.1	2293777	150	160	16,6	8,5	8,4



Grenrør

Geberit Silent-Pro grenrør 45°

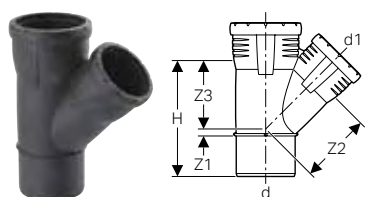

click & scan

Art. nr.	NRF nr.	DN	d, ø [mm]	d1, ø [mm]	arc [°]	H [cm]	Z1 [cm]	Z2 [cm]	Z3 [cm]
393.232.14.1	2293778	50 / 50	50	50	45	12,9	1,5	6,3	6,3
393.332.14.1	2293779	70 / 50	75	50	45	13,5	0,1	8,1	7,8
393.333.14.1	2293781	70 / 70	75	75	45	16,9	1,9	9,4	9,4
393.432.14.1	2293782	90 / 50	90	50	45	13,9	0,6	9,2	8,4
393.433.14.1	2293783	90 / 70	90	75	45	17,5	1,2	10,5	10,2
393.434.14.1	2293784	90 / 90	90	90	45	19,6	2,2	11,3	11,3
393.532.14.1	2293785	100 / 50	110	50	45	15,1	1,5	10,6	9,8
393.533.14.1	2293786	100 / 70	110	75	45	18,5	0,2	11,9	11,5
393.534.14.1	2293787	100 / 90	110	90	45	20,5	1,1	12,6	12,6
393.535.14.1	2293788	100 / 100	110	110	45	23,3	2,7	13,8	13,8
393.633.14.1	2293789	125 / 70	125	75	45	20,1	0,4	13,3	13,1
393.634.14.1	2293791	125 / 90	125	90	45	24,3	2,8	18,4	14,2
393.635.14.1	2293792	125 / 100	125	110	45	24,3	2,1	14,7	14,9
393.636.14.1	2293793	125 / 125	125	125	45	26,2	3,1	15,7	15,7
393.734.14.1	2293794	150 / 90	160	90	45	25,2	1	21	16,2
393.735.14.1	2293795	150 / 100	160	110	45	25,2	0,3	17,3	16,9
393.736.14.1	2293796	150 / 125	160	125	45	27,3	1,4	18,4	17,9
393.737.14.1	2293797	150 / 150	160	160	45	32,4	4	20,3	20,3



- Artikkel 393.634.14.1 og 393.734.14.1 består av et likt grenrør og et tilsvarende reduksjonsstykke. Disse delene blir levert separat i en pose

Geberit Silent-Pro grenrør 87,5°

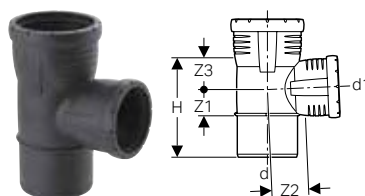

click & scan

Art. nr.	NRF nr.	DN	d, ø [mm]	d1, ø [mm]	arc [°]	H [cm]	Z1 [cm]	Z2 [cm]	Z3 [cm]
393.248.14.1	2293798	50 / 50	50	50	87,5	10,9	2,9	2,8	2,9
393.348.14.1	2293799	70 / 50	75	50	87,5	11,5	2,8	4,2	3,1
393.349.14.1	2293801	70 / 70	75	75	87,5	13,9	3,9	4,3	4,3
393.448.14.1	2293802	90 / 50	90	50	87,5	12,1	2,8	4,9	3,2
393.449.14.1	2293803	90 / 70	90	75	87,5	14,6	4	5,1	4,5
393.547.14.1	2293804	100 / 50	110	50	87,5	12,9	2,8	6	3,2
393.549.14.1	2293805	100 / 70	110	75	87,5	15,4	4	6	4,5
393.654.14.1	2293806	125 / 70	125	75	87,5	23	9	12,2	6,5
393.650.14.1	2293815	125 / 90	125	90	87,5	23	8,3	12	7,3
393.652.14.1	2293807	125 / 125	125	125	87,5	20,9	6,5	6,8	7
393.751.14.1	2293808	150 / 100	160	110	87,5	25,2	10,2	13,3	7
393.752.14.1	2293809	150 / 125	160	125	87,5	25,2	9,4	13	7,7
393.753.14.1	2293811	150 / 150	160	160	87,5	25,2	8,3	8,6	8,8



- Artikkel 393.650.14.1, 393.654.14.1, 393.751.14.1 og 393.752.14.1 består av et likt grenrør og et tilsvarende reduksjonsstykke. Disse delene blir levert separat i en pose

Geberit Silent-Pro grenrør 87,5°

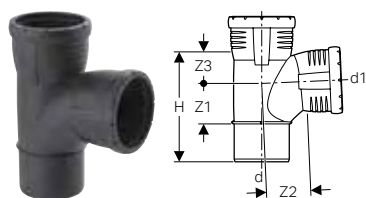

click & scan

Art. nr.	NRF nr.	DN	d, ø [mm]	d1, ø [mm]	arc [°]	H [cm]	Z1 [cm]	Z2 [cm]	Z3 [cm]
393.454.14.1	2293812	90 / 90	90	90	87,5	17	6,7	7	4,9
393.552.14.1	2293813	100 / 90	110	90	87,5	21,2	8,2	8,1	6,1
393.555.14.1	2293814	100 / 100	110	110	87,5	21,2	8,2	7,7	6,1
393.651.14.1	2293816	125 / 100	125	110	87,5	21,3	6,6	7,8	7,3

Geberit Silent-Pro grenrør 87,5° dobbelt

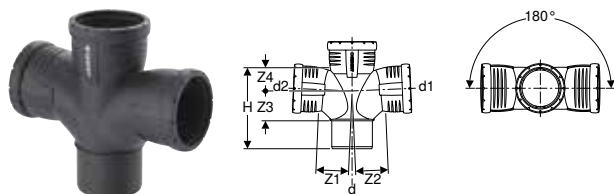

click & scan

Art. nr.	NRF nr.	DN	d, ø [mm]	d1, ø [mm]	d2, ø [mm]	arc [°]	H [cm]	Z1 [cm]	Z2 [cm]	Z3 [cm]	Z4 [cm]
393.466.14.1	2293817	90 / 90 / 90	90	90	90	180	17,7	7	7	6,7	4,9
393.566.14.1	2293818	100 / 100 / 100	110	110	110	180	21,2	7,7	7,7	8,2	6,1
393.665.14.1	2293819	125 / 100 / 100	125	110	110	180	22,9	8,2	8,2	7,7	7,8



- Art. nr. 393.665.14.1 er et sveiset formstykke

Geberit Silent-Pro kombi-grenrør 87,5°

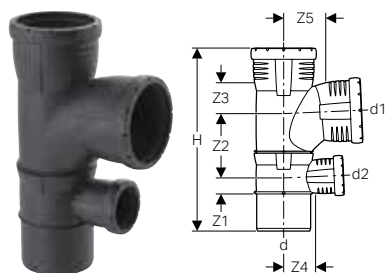

click & scan

Art. nr.	NRF nr.	DN	d, ø [mm]	d1, ø [mm]	d2, ø [mm]	arc [°]	H [cm]	Z1 [cm]	Z2 [cm]	Z3 [cm]	Z4 [cm]	Z5 [cm]
393.456.14.1	2293835	90 / 90 / 50	90	90	50	87,5	30,6	2,8	10,8	4,9	4,9	7
393.556.14.1	2293836	100 / 90 / 50	110	90	50	87,5	34,9	2,8	12,3	6,1	6	8
393.558.14.1	2293837	100 / 100 / 50	110	110	50	87,5	34,9	2,8	12,3	6,1	6	7,7

Geberit Silent-Pro parallellgren 45°

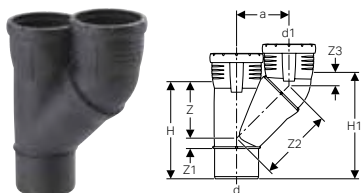

click & scan

Art. nr.	NRF nr.	DN	d, ø [mm]	d1, ø [mm]	arc [°]	a [cm]	H [cm]	H1 [cm]	Z [cm]	Z1 [cm]	Z2 [cm]	Z3 [cm]
393.457.14.1	2293821	90 / 90	90	90	45	11,2	19,6	22	11,3	2,2	15,8	2,3
393.551.14.1	2293822	100 / 90	110	90	45	12,3	20,5	22,7	12,6	1,1	17,4	2,2
393.557.14.1	2293823	100 / 100	110	110	45	13,3	23,3	25,7	13,8	2,7	18,4	2,4

Geberit Silent-Pro sjaktgrenrør 87,5° venstre

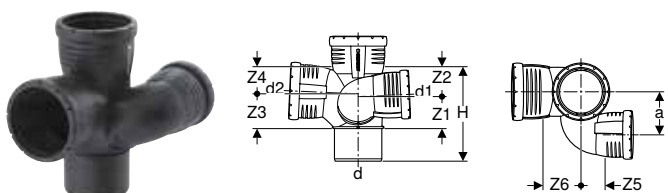

click & scan

Art. nr.	NRF nr.	DN	d, ø [mm]	d1, ø [mm]	d2, ø [mm]	a [cm]	H [cm]	Z1 [cm]	Z2 [cm]	Z3 [cm]	Z4 [cm]	Z5 [cm]	Z6 [cm]
393.464.14.1	2293824	90 / 70 / 90	90	75	90	8,2	17,7	6,2	5,4	6,7	4,9	4,2	7
393.554.14.1	2293825	100 / 70 / 90	110	75	90	9,2	21,2	7,7	6,7	8,2	6,1	4,2	8,1
393.564.14.1	2293826	100 / 70 / 100	110	75	110	7,7	21,2	6,7	7,7	8,2	6,1	4,2	7,7

Geberit Silent-Pro sjaktgrenrør 87,5° høyre

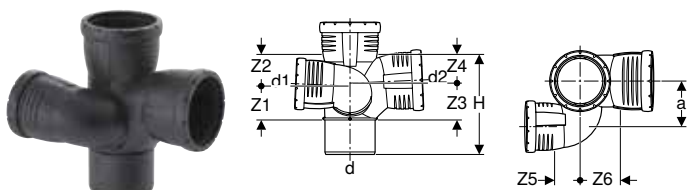

click & scan

Art. nr.	NRF nr.	DN	d, ø [mm]	d1, ø [mm]	d2, ø [mm]	a [cm]	H [cm]	Z1 [cm]	Z2 [cm]	Z3 [cm]	Z4 [cm]	Z5 [cm]	Z6 [cm]
393.463.14.1	2293827	90 / 70 / 90	90	75	90	8,2	17,7	6,7	4,9	6,2	5,4	4,2	7
393.553.14.1	2293828	100 / 70 / 90	110	75	90	9,2	21,2	7,7	6,7	8,2	6,1	4,2	8,1
393.563.14.1	2293829	100 / 70 / 100	110	75	110	9,2	21,2	6,7	7,7	8,2	6,1	4,2	7,7

Geberit Silent-Pro hjørnegren 87,5°

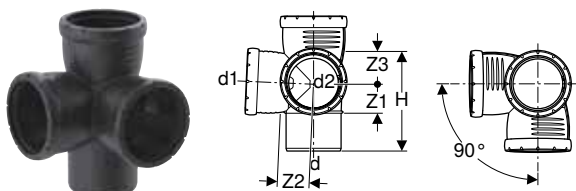

click & scan

Art. nr.	NRF nr.	DN	d, ø [mm]	d1, ø [mm]	d2, ø [mm]	arc [°]	H [cm]	Z1 [cm]	Z2 [cm]	Z3 [cm]
393.459.14.1	2293831	90 / 90 / 90	90	90	90	90	16	4,9	5	5,1
393.550.14.1	2293832	100 / 90 / 90	110	90	90	90	21,2	8,2	8,1	6,1
393.559.14.1	2293833	100 / 100 / 100	110	110	110	90	18,9	5,9	6	6,2
393.662.14.1	2293834	125 / 100 / 100	125	110	110	90	22,9	7,7	8,2	7,8



• Art. nr. 393.550.14.1 og 393.662.14.1 er sveisede formstykker med innvendig radius

Geberit Silent-Pro kombi-bendhjørnegren 87,5° venstre

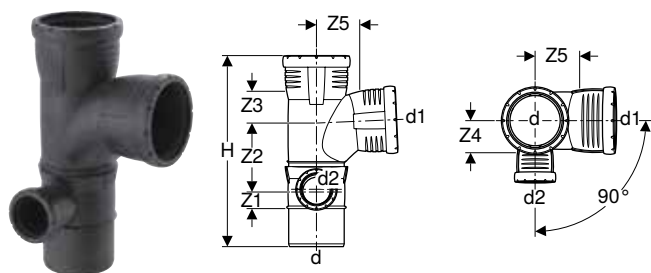

click & scan

Art. nr.	NRF nr.	DN	d, ø [mm]	d1, ø [mm]	d2, ø [mm]	arc [°]	H [cm]	Z1 [cm]	Z2 [cm]	Z3 [cm]	Z4 [cm]	Z5 [cm]
393.470.14.1	2293838	90 / 90 / 50	90	90	50	90	30,6	2,8	10,8	4,9	4,9	7
393.561.14.1	2293842	100 / 100 / 70	110	110	75	90	37,4	4	13,6	6,1	5,9	7,7
393.570.14.1	2293839	100 / 90 / 50	110	90	50	90	34,9	2,8	12,2	6,1	6	8,1
393.578.14.1	2293841	100 / 100 / 50	110	110	50	90	34,9	2,8	12,3	6,1	6	7,7

Geberit Silent-Pro kombi-bendhjørnegren 87,5° høyre

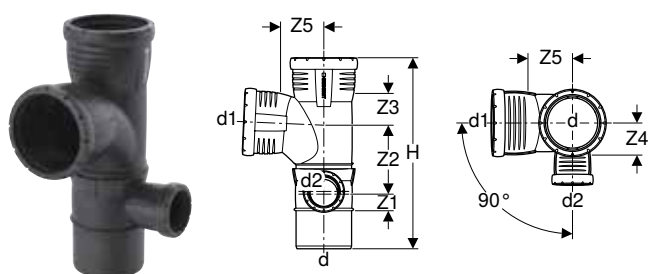

click & scan

Art. nr.	NRF nr.	DN	d, ø [mm]	d1, ø [mm]	d2, ø [mm]	arc [°]	H [cm]	Z1 [cm]	Z2 [cm]	Z3 [cm]	Z4 [cm]	Z5 [cm]
393.462.14.1	2293843	90 / 90 / 50	90	90	50	90	30,6	2,8	10,8	4,9	4,9	7
393.560.14.1	2293846	100 / 100 / 70	110	110	75	90	37,4	4	13,6	6,1	5,9	7,7
393.562.14.1	2293844	100 / 90 / 50	110	90	50	90	34,9	2,8	12,2	6,1	6	8,1
393.565.14.1	2293845	100 / 100 / 50	110	110	50	90	34,5	2,8	12,3	6,1	6	7,7

Reduksjoner

Geberit Silent-Pro eksentrisk reduksjon

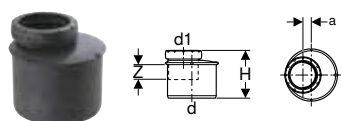

click & scan

Art. nr.	NRF nr.	DN	d, ø [mm]	d1, ø [mm]	a [cm]	H [cm]	Z [cm]
393.372.14.1	2293847	70 / 50	75	50	0,8	8,4	2,9
393.472.14.1	2293848	90 / 50	90	50	1,5	8,8	2,3
393.473.14.1	2293849	90 / 70	90	75	0,3	8,9	2,7
393.572.14.1	2293851	100 / 50	110	50	2,5	9,5	2,2
393.573.14.1	2293852	100 / 70	110	75	1,3	9,6	2,8
393.574.14.1	2293853	100 / 90	110	90	0,5	9,8	3,1
393.674.14.1	2293854	125 / 90	125	90	1,2	10,4	2,9
393.675.14.1	2293855	125 / 100	125	110	0,2	10,5	3,7
393.775.14.1	2293856	150 / 100	160	110	1,9	11,3	3,4
393.776.14.1	2293857	150 / 125	160	125	1,1	11,5	3,8

Stakeluger

Geberit Silent-Pro stakeluke 90° med rund serviceåpning

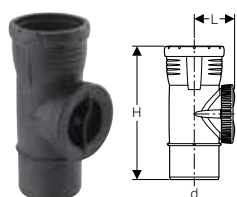

click & scan

Art. nr.	NRF nr.	DN	d, ø [mm]	L [cm]	H [cm]
393.227.14.1	2293858	50	50	4,6	18
393.327.14.1	2293859	70	75	6	21,6
393.427.14.1	2293861	90	90	7,2	24,4
393.527.14.1	2293862	100	110	8,7	28,4
393.627.14.1	2293863	125	125	9,5	28,9
393.727.14.1	2293864	150	160	11,4	30,5

Geberit Silent-Pro stakeluke 90° med oval serviceåpning

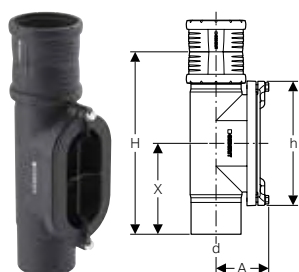

click & scan

Art. nr.	NRF nr.	DN	d, ø [mm]	A [cm]	H [cm]	h [cm]	X [cm]
393.503.14.1	2293865	100	110	12	40,3	28	20
393.603.14.1	2293866	125	125	12,5	41,4	28	20,5
393.703.14.1	2293867	150	160	14	43,4	28	21,5

SuperTube-formstykker

Bend

Ny

Geberit Silent-Pro BottomTurn-bend

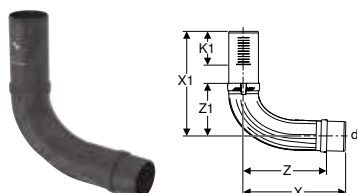

click & scan

Art. nr.	NRF nr.	DN	d, ø [mm]	X [cm]	X1 [cm]	Z [cm]	Z1 [cm]	K1 maks. [cm]
393.425.14.1	2294151	90	90	31,7	37,5	25,6	16,2	14,3
393.525.14.1	2294152	100	110	37,9	39,1	31,1	18,9	12,4

Kan leveres fra april 2024

Ny

Geberit Silent-Pro BackFlip-bend

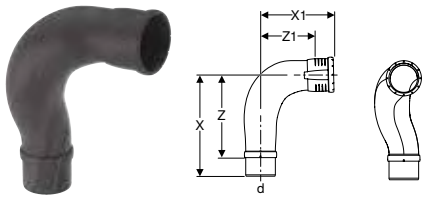

click & scan

Art. nr.	NRF nr.	DN	d, ø [mm]	X [cm]	X1 [cm]	Z [cm]	Z1 [cm]
393.426.14.1	2294153	90	90	31,6	23,7	25,2	16,8
393.526.14.1	2294154	100	110	37,8	28,2	30,3	20,4

Kan leveres fra april 2024

Grenrør

Ny

Geberit Silent-Pro Carve grenrør 87,5°

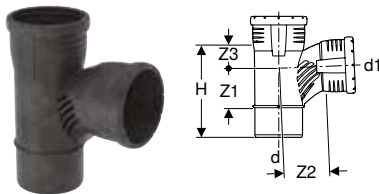

click & scan

Art. nr.	NRF nr.	DN	d, ø [mm]	d1, ø [mm]	H [cm]	Z1 [cm]	Z2 [cm]	Z3 [cm]
393.444.14.1	2294144	90 / 50	90	50	12,9	5,4	8,9	1,4
393.445.14.1	2294146	90 / 70	90	75	14,4	5,4	8,9	2,9
393.440.14.1	2294137	90 / 90	90	90	16,9	7,9	10,4	2,9
393.544.14.1	2294145	100 / 50	110	50	12,9	4,7	8,9	1,4
393.545.14.1	2294147	100 / 70	110	75	15,2	5,2	8,9	3,2
393.541.14.1	2294139	100 / 90	110	90	18,3	7,3	10,4	4,2
393.540.14.1	2294138	100 / 100	110	110	21,2	9,2	10,7	5,2

Kan leveres fra april 2024

Ny

Geberit Silent-Pro Carve grenrør 87,5° med tre muffe

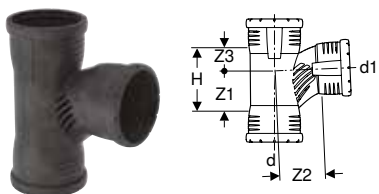

click & scan

Art. nr.	NRF nr.	DN	d, ø [mm]	d1, ø [mm]	H [cm]	Z1 [cm]	Z2 [cm]	Z3 [cm]
393.446.14.1	2294148	90 / 50	90	50	6,8	5,4	8,9	1,4
393.442.14.1	2294141	90 / 90	90	90	10,8	7,9	10,4	2,9
393.546.14.1	2294149	100 / 50	110	50	6,6	5,2	8,9	1,4
393.543.14.1	2294143	100 / 90	110	90	11,9	7,7	10,4	4,2
393.542.14.1	2294142	100 / 100	110	110	14,9	9,7	10,7	5,2

Kan leveres fra april 2024

Forbindelser

Muffer

Geberit Silent-Pro dobbelstikkemuffe

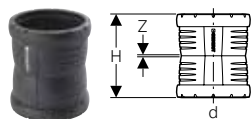

click & scan

Art. nr.	NRF nr.	DN	d, ø [mm]	H [cm]	Z [cm]
393.216.14.1	2293868	50	50	10,3	0,1
393.316.14.1	2293869	70	75	11,3	0,2
393.416.14.1	2293871	90	90	12,4	0,2
393.516.14.1	2293872	100	110	13,9	0,3
393.616.14.1	2293873	125	125	15,2	0,4
393.716.14.1	2293874	150	160	16,5	0,4

Geberit Silent-Pro ekspansjonsmuffe

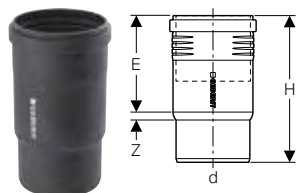

click & scan

Art. nr.	NRF nr.	DN	d, ø [mm]	E [cm]	H [cm]	Z [cm]
393.218.14.1	2293882	50	50	4,8–11,4	17	0,3
393.318.14.1	2293883	70	75	5,6–12,1	18,4	0,6
393.418.14.1	2293884	90	90	6–13,6	20,2	0,3
393.518.14.1	2293885	100	110	6,6–15	22,5	0,5

Geberit Silent-Pro glidemuffe



click & scan

Art. nr.	NRF nr.	DN	d, ø [mm]	H [cm]
393.217.14.1	2293875	50	50	10,3
393.317.14.1	2293876	70	75	11,3
393.417.14.1	2293877	90	90	12,4
393.517.14.1	2293878	100	110	13,9
393.617.14.1	2293879	125	125	15,2
393.717.14.1	2293881	150	160	16,5

Kloforbindelser

Geberit holdeklo

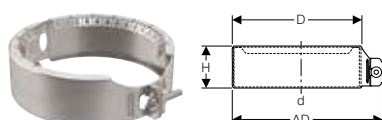

click & scan

Art. nr.	NRF nr.	DN	d, ø [mm]	AD min. [cm]	D [cm]	H [cm]
390.203.14.1	2293911	50	50	8,2	7	3,8
390.308.14.1	2293912	70	75	10,9	9,6	3,7
390.408.14.1	2293913	90	90	12,6	11,3	4,1

Art. nr.	NRF nr.	DN	d, ø [mm]	AD min. [cm]	D [cm]	H [cm]
390.508.14.1	2293914	100	110	14,7	13,5	4,1
390.608.14.1	2293915	125	125	16,5	15,2	4,5
390.708.14.1	2293916	150	160	20,6	19,3	5

Overganger til andre materialer

Geberit kromstålkobling

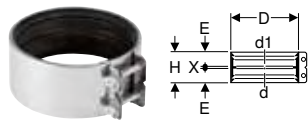

click & scan

Art. nr.	NRF nr.	DN	d, ø [mm]	d1, ø [mm]	D [cm]	E [cm]	H [cm]	X [cm]
359.465.00.2	2293909	50	50	58	7,5	2,7	5,7	0,3
359.434.00.2	2293931	70	75-76	78	9,3	2,7	5,7	0,3
359.435.00.2	2293932	70	75-76	83-84	9,8	2,7	5,7	0,3
359.437.00.2	2293933	90	89-90	83-84	11,1	2,7	5,7	0,3
359.441.00.2	2293906	100	108-110	108-110	12,5	2,7	5,7	0,3
359.444.00.2	2293907	125	125	131-135	15	3,3	6,9	0,3
359.449.00.2	2293908	150	159-160	159-160	17,5	3,3	6,9	0,3

Geberit Silent-PP reduksjonsmuffe på Geberit Silent-db20

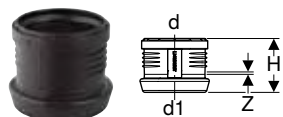

click & scan

Art. nr.	NRF nr.	DN	d, ø [mm]	d1, ø [mm]	H [cm]	Z [cm]
390.296.14.1	2294675	50 / 56	50	56	8,7	0,3
390.396.14.1	2294702	70 / 70	75	75	9,2	0,3
390.496.14.1	2294738	90 / 90	90	90	9,7	0,3
390.596.14.1	2294783	100 / 100	110	110	10,4	0,3
390.696.14.1	2294812	125 / 125	125	135	12	0,3
390.796.14.1	2294836	150 / 150	160	160	13,6	0,4

Tilbehør

Klammer

Geberit klammer isolert, med gjenget rørmuffe M8 / M10

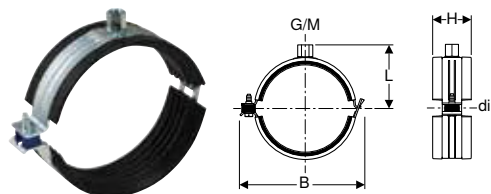

click & scan

Art. nr.	NRF nr.	Farge / overflate	DN	M [mm]	di, ø [mm]	L [cm]	B [cm]	H [cm]
393.299.26.1	2293887	El-forsinket	50	8 / 10	50	4,8	8,8	4
393.399.26.1	2293888	El-forsinket	70	8 / 10	75	6,2	12,6	4
393.499.26.1	2293889	El-forsinket	90	8 / 10	90	6,8	13,7	5
393.599.26.1	2293891	El-forsinket	100	8 / 10	110	7,7	15,6	5

Geberit klammer isolert, med gjenget rørmuffe M10 / M12

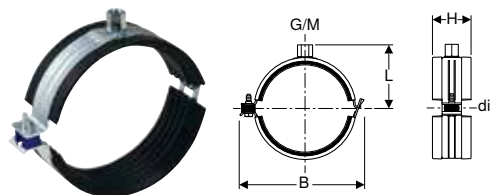

click & scan

Art. nr.	NRF nr.	Farge / overflate	DN	M [mm]	di, ø [mm]	L [cm]	B [cm]	H [cm]
393.699.26.1	2293892	El-forsinket	125	10 / 12	125	8,9	17,4	5
393.799.26.1	2293893	El-forsinket	150	10 / 12	160	9,9	21,2	5

Endedeckler

Geberit Silent-PP muffeplugg



click & scan

Art. nr.	NRF nr.	DN	d, ø [mm]	H [cm]
390.228.14.1	2294657	50	50	4,7
390.328.14.1	2294692	70	75	5,4
390.428.14.1	2294718	90	90	6
390.528.14.1	2294755	100	110	6,6
390.628.14.1	2294799	125	125	7,3
390.728.14.1	2294826	150	160	7,9

Geberit Silent-Pro reparasjonsrondell



click & scan

Art. nr.	NRF nr.	d, ø [mm]
359.153.14.1	2293886	50-160

Pakninger

Geberit leppetetning i EPDM



click & scan

Art. nr.	NRF nr.	DN	d, ø [mm]
241.786.00.1		50	50
241.787.00.1		70	75
241.790.00.1		90	90
241.791.00.1	2293894	100	110
242.279.00.1		125	125
242.280.00.1		150	160

Forbruksmateriell

Geberit glidemiddel 250 ml



[click & scan](#)

Art. nr.	NRF nr.
953.761.00.1	2293918

Geberit markeringspenn med justerbar fettstift



[click & scan](#)

Art. nr.	Farge / overflate
690.102.00.1	Gul

Tilbehør

- Geberit reserve fettstift for markeringspenn med justerbar fettstift → s. 187

Geberit reserve fettstift for markeringspenn med justerbar fettstift



[click & scan](#)

Art. nr.	Farge / overflate
690.103.00.1	Gul





Geberit Silent-PP

Rør	190
Formstykker	191
Bend	191
Grenrør	192
Reduksjoner	195
Stakeluker	197
Forbindelser	197
Muffer	197
Kloforbindelser	198
Overganger til andre materialer	199
Utstyrstilkoblinger	200
Tilslutningsbender	200
Tilkoblingsrør	201
Tilbehør	202
Klammer	202
Endedeksler	202
Pakninger	203
Forbruksmateriell	204



Rør

Geberit Silent-PP rør med muffe

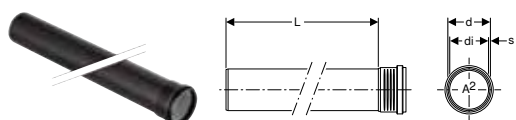

click & scan

Art. nr.	NRF nr.	DN	d, ø [mm]	di, ø [mm]	s [mm]	A ² [cm ²]
L / Lengde: 15 cm						
390.000.14.1		30	32	28	2	6,2
390.100.14.1		40	40	36	2	10,2
390.200.14.1		50	50	46	2	16,6
390.300.14.1		70	75	69,8	2,6	38,3
390.400.14.1		90	90	83,8	3,1	55,2
390.500.14.1		100	110	102,8	3,6	83
390.600.14.1		125	125	116,6	4,2	106,8
390.700.14.1		150	160	149,6	5,2	175,8
L / Lengde: 25 cm						
390.001.14.1		30	32	28	2	6,2
390.101.14.1		40	40	36	2	10,2
390.201.14.1		50	50	46	2	16,6
390.301.14.1		70	75	69,8	2,6	38,3
390.401.14.1		90	90	83,8	3,1	55,2
390.501.14.1		100	110	102,8	3,6	83
390.601.14.1		125	125	116,6	4,2	106,8
390.701.14.1		150	160	149,6	5,2	175,8
L / Lengde: 50 cm						
390.002.14.1		30	32	28	2	6,2
390.102.14.1		40	40	36	2	10,2
390.202.14.1		50	50	46	2	16,6
390.302.14.1		70	75	69,8	2,6	38,3
390.402.14.1		90	90	83,8	3,1	55,2
390.502.14.1		100	110	102,8	3,6	83
390.602.14.1		125	125	116,6	4,2	106,8
390.702.14.1		150	160	149,6	5,2	175,8
L / Lengde: 100 cm						
390.004.14.1	2294601	30	32	28	2	6,2
390.104.14.1	2294618	40	40	36	2	10,2
390.204.14.1	2294642	50	50	46	2	16,6
390.304.14.1	2294677	70	75	69,8	2,6	38,3
390.404.14.1	2294704	90	90	83,8	3,1	55,2
390.504.14.1	2294741	100	110	102,8	3,6	83
390.604.14.1	2294785	125	125	116,6	4,2	106,8
390.704.14.1	2294814	150	160	149,6	5,2	175,8
L / Lengde: 150 cm						
390.005.14.1		30	32	28	2	6,2
390.105.14.1		40	40	36	2	10,2
390.205.14.1		50	50	46	2	16,6
390.305.14.1		70	75	69,8	2,6	38,3
390.405.14.1		90	90	83,8	3,1	55,2
390.505.14.1		100	110	102,8	3,6	83
390.605.14.1		125	125	116,6	4,2	106,8
390.705.14.1		150	160	149,6	5,2	175,8
L / Lengde: 200 cm						
390.006.14.1		30	32	28	2	6,2
390.106.14.1		40	40	36	2	10,2
390.206.14.1		50	50	46	2	16,6
390.306.14.1		70	75	69,8	2,6	38,3
390.406.14.1		90	90	83,8	3,1	55,2
390.506.14.1		100	110	102,8	3,6	83
390.606.14.1		125	125	116,6	4,2	106,8
390.706.14.1		150	160	149,6	5,2	175,8
L / Lengde: 300 cm						
390.007.14.1	2294602	30	32	28	2	6,2
390.107.14.1	2294619	40	40	36	2	10,2
390.207.14.1	2294643	50	50	46	2	16,6
390.307.14.1	2294678	70	75	69,8	2,6	38,3

Art. nr.	NRF nr.	DN	d, ø [mm]	di, ø [mm]	s [mm]	A ² [cm ²]
390.407.14.1	2294705	90	90	83,8	3,1	55,2
390.507.14.1	2294742	100	110	102,8	3,6	83
390.607.14.1	2294786	125	125	116,6	4,2	106,8
390.707.14.1	2294815	150	160	149,6	5,2	175,8

Formstykker

Bend

Geberit Silent-PP bend

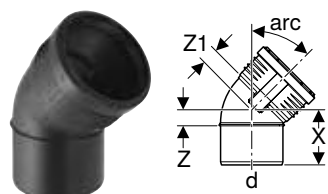

click & scan

Art. nr.	NRF nr.	DN	d, ø [mm]	X [cm]	Z [cm]	Z1 [cm]
arc / Vinkel: 15°						
390.020.14.1	2294607	30	32	5	0,6	1
390.120.14.1	2294626	40	40	5,4	0,7	1,1
390.220.14.1	2294649	50	50	5,8	0,7	1,1
390.320.14.1	2294685	70	75	6,5	0,9	1,5
390.420.14.1	2294712	90	90	7,3	1,2	1,7
390.520.14.1	2294748	100	110	8,2	1,4	2
390.620.14.1	2294793	125	125	8,8	1,4	2,3
390.720.14.1	2294819	150	160	9,7	1,7	2,6
arc / Vinkel: 30°						
390.021.14.1	2294608	30	32	5,2	0,8	0,9
390.121.14.1	2294627	40	40	5,7	0,9	1
390.221.14.1	2294651	50	50	6,2	1,1	1
390.321.14.1	2294686	70	75	7	1,5	1,5
390.421.14.1	2294713	90	90	7,9	1,8	1,7
390.521.14.1	2294749	100	110	9	2,1	2,2
390.621.14.1	2294794	125	125	9,8	2,4	2,5
390.721.14.1	2294821	150	160	11	3	2,8
arc / Vinkel: 45°						
390.022.14.1	2294609	30	32	5,5	1	1,1
390.122.14.1	2294628	40	40	6	1,2	1,3
390.222.14.1	2294652	50	50	6,5	1,5	1,4
390.322.14.1	2294687	70	75	7,6	2	2,1
390.422.14.1	2294714	90	90	8,5	2,4	2,5
390.522.14.1	2294751	100	110	9,7	3	2,9
390.622.14.1	2294795	125	125	10,7	3,3	3,3
390.722.14.1	2294822	150	160	12,2	4,2	4
arc / Vinkel: 67,5°						
390.023.14.1	2294611	30	32	5,9	1,5	1,5
390.123.14.1	2294629	40	40	6,5	1,8	1,8
390.223.14.1	2294653	50	50	7,2	2,1	2,1
390.323.14.1	2294688	70	75	8,6	3	3
390.423.14.1	2294715	90	90	9,7	3,6	3,5
390.523.14.1	2294752	100	110	11,2	4,4	4,3
390.623.14.1	2294796	125	125	12,3	4,9	4,9
390.723.14.1	2294823	150	160	14,3	6,2	6,1
arc / Vinkel: 87,5°						
390.024.14.1	2294612	30	32	6,4	1,9	2
390.124.14.1	2294631	40	40	7,1	2,3	2,5
390.224.14.1	2294654	50	50	7,9	2,8	3
390.324.14.1	2294689	70	75	9,7	4,1	4,2
390.424.14.1	2294716	90	90	11	4,9	4,8
390.524.14.1	2294753	100	110	12,8	6	6
390.624.14.1	2294797	125	125	14,2	6,8	6,7
390.724.14.1	2294824	150	160	16,6	8,5	8,4



Grenrør

Geberit Silent-PP grenrør 45°

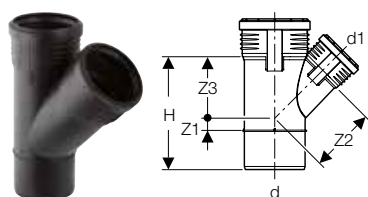

click & scan

Art. nr.	NRF nr.	DN	d, ø [mm]	d1, ø [mm]	arc [°]	H [cm]	Z1 [cm]	Z2 [cm]	Z3 [cm]
390.030.14.1	2294613	30 / 30	32	32	45	9,4	1	4	4
390.130.14.1	2294633	40 / 30	40	32	45	9,7	0,6	4,6	4,4
390.131.14.1	2294634	40 / 40	40	40	45	9,8	1,2	5	5
390.230.14.1	2294658	50 / 30	50	32	45	10	0,1	5,3	4,9
390.231.14.1	2294659	50 / 40	50	40	45	10,2	0,7	5,8	5,6
390.232.14.1	2294661	50 / 50	50	50	45	12,7	1	6,3	6,3
390.331.14.1	2294693	70 / 40	75	40	45	12	0,6	7,6	7
390.332.14.1	2294694	70 / 50	75	50	45	13,4	0,1	8,1	7,6
390.333.14.1	2294695	70 / 70	75	75	45	15	1,9	9,4	9,4
390.432.14.1	2294719	90 / 50	90	50	45	13	0,6	9,1	8,4
390.433.14.1	2294721	90 / 70	90	75	45	17,5	1,2	10,4	10,2
390.434.14.1	2294722	90 / 90	90	90	45	19,6	2,2	11,3	11,3
390.531.14.1	2294756	100 / 40	110	40	45	13,4	2,2	10,1	8,8
390.532.14.1	2294757	100 / 50	110	50	45	14,8	1,5	10,6	9,5
390.533.14.1	2294758	100 / 70	110	75	45	18,3	0,2	11,9	11,2
390.534.14.1	2294759	100 / 90	110	90	45	20,3	1,3	12,6	12,2
390.535.14.1	2294761	100 / 100	110	110	45	23,3	2,7	13,8	13,8
390.634.14.1	2294801	125 / 90	125	90	45	21	0,6	13,6	12,9
390.635.14.1	2294802	125 / 100	125	110	45	23,7	2,1	14,7	14,3
390.636.14.1	2294803	125 / 125	125	125	45	25,9	3,1	15,4	15,4
390.735.14.1	2294827	150 / 100	160	110	45	24,5	0,4	17,2	16,1
390.736.14.1	2294828	150 / 125	160	125	45	26,6	1,4	17,9	17,1
390.737.14.1	2294829	150 / 150	160	160	45	31,5	3,9	19,6	19,5

Geberit Silent-PP buksegren 45° dobbelt

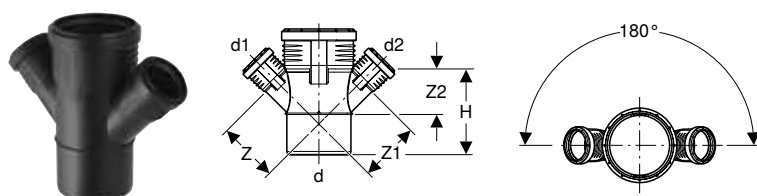

click & scan

Art. nr.	NRF nr.	DN	d, ø [mm]	d1, ø [mm]	d2, ø [mm]	arc [°]	H [cm]	Z [cm]	Z1 [cm]	Z2 [cm]
390.469.14.1	2294732	90 / 50 / 50	90	50	50	180	13,9	9,1	9,1	8,4
390.569.14.1	2294774	100 / 50 / 50	110	50	50	180	14,8	10,6	10,6	9,5

Geberit Silent-PP grenrør 87,5°

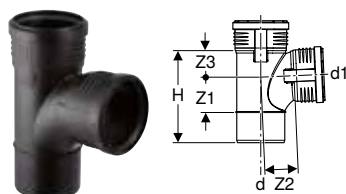

click & scan

Art. nr.	NRF nr.	DN	d, ø [mm]	d1, ø [mm]	arc [°]	H [cm]	Z1 [cm]	Z2 [cm]	Z3 [cm]
390.454.14.1	2294725	90 / 90	90	90	87,5	17,7	6,7	7	4,9
390.554.14.1	2294765	100 / 90	110	90	87,5	18,6	6,8	8,1	5
390.555.14.1	2294766	100 / 100	110	110	87,5	21,2	8,2	7,7	6,1

Geberit Silent-PP grenrør 87,5°

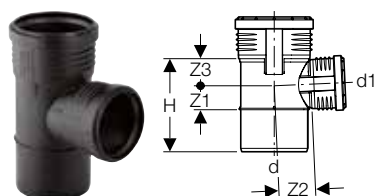

click & scan

Art. nr.	NRF nr.	DN	d, ø [mm]	d1, ø [mm]	arc [°]	H [cm]	Z1 [cm]	Z2 [cm]	Z3 [cm]
390.046.14.1	2294614	30 / 30	32	32	87,5	8,2	1,7	2,1	2,1
390.147.14.1	2294635	40 / 40	40	40	87,5	9,2	2,2	2,2	2,2
390.247.14.1	2294662	50 / 40	50	40	87,5	9,5	2,2	2,8	2,2
390.248.14.1	2294663	50 / 50	50	50	87,5	10,5	2,7	2,8	2,8
390.347.14.1	2294696	70 / 40	75	40	87,5	10,4	2,3	4,2	2,6
390.348.14.1	2294697	70 / 50	75	50	87,5	11,4	2,8	4,2	3,1
390.349.14.1	2294698	70 / 70	75	75	87,5	13,9	4	4,3	4,3
390.448.14.1	2294723	90 / 50	90	50	87,5	12,1	2,8	4,9	3,2
390.449.14.1	2294724	90 / 70	90	75	87,5	14,6	4	5,1	4,5
390.547.14.1	2294762	100 / 40	110	40	87,5	12,4	2,7	6	2,9
390.548.14.1	2294763	100 / 50	110	50	87,5	12,9	2,8	6	3,2
390.549.14.1	2294764	100 / 70	110	75	87,5	15,4	4	6,1	4,5
390.650.14.1	2294804	125 / 90	125	90	87,5	17,1	4,6	6,9	5,2
390.651.14.1	2294805	125 / 100	125	110	87,5	21,3	6,6	7,8	7,3
390.652.14.1	2294806	125 / 125	125	125	87,5	20,6	6,4	6,8	6,8
390.751.14.1	2294831	150 / 100	160	110	87,5	19,8	5,5	8,8	6,2
390.752.14.1	2294832	150 / 125	160	125	87,5	21,3	6,4	8,7	6,9
390.753.14.1	2294833	150 / 150	160	160	87,5	24,8	8,2	8,6	8,6

Geberit Silent-PP grenrør 87,5° dobbelt

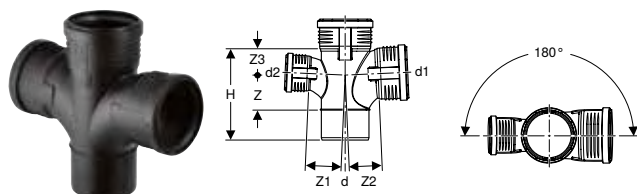

click & scan

Art. nr.	NRF nr.	DN	d, ø [mm]	d1, ø [mm]	d2, ø [mm]	arc [°]	H [cm]	Z [cm]	Z1 [cm]	Z2 [cm]	Z3 [cm]
390.466.14.1	2294731	90 / 90 / 90	90	90	90	180	17,7	6,7	7	7	4,9
390.567.14.1	2294773	100 / 100 / 70	110	110	75	180	21,2	8,2	8,3	7,7	6,1
390.566.14.1	2294772	100 / 100 / 100	110	110	110	180	21,2	8,2	7,7	7,7	6,1

Geberit Silent-PP buksegren 87,5° dobbelt

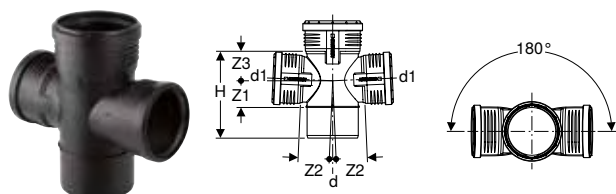

click & scan

Art. nr.	NRF nr.	DN	d, ø [mm]	d1, ø [mm]	arc [°]	H [cm]	Z1 [cm]	Z2 [cm]	Z3 [cm]
390.665.14.1	2294808	125 / 100 / 100	125	110	180	21,3	6,6	7,8	7,3

Geberit Silent-PP hjørnegren 87,5°

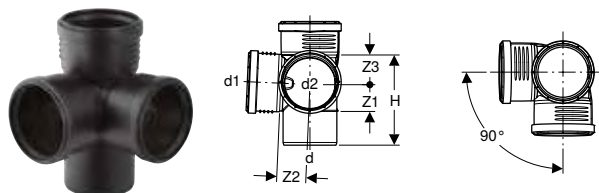

click & scan

Art. nr.	NRF nr.	DN	d, ø [mm]	d1, ø [mm]	d2, ø [mm]	arc [°]	H [cm]	Z1 [cm]	Z2 [cm]	Z3 [cm]
390.459.14.1	2294727	90 / 90 / 90	90	90	90	90	15,7	4,6	5	5
390.559.14.1	2294768	100 / 100 / 100	110	110	110	90	18,6	5,6	6	6,1
390.662.14.1	2294807	125 / 100 / 100	125	110	110	90	21,3	6,6	7,8	7,3

Geberit Silent-PP kombi-bendhjørnegren 87,5° venstre

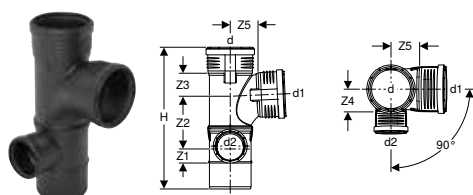

click & scan

Art. nr.	DN	d, ø [mm]	d1, ø [mm]	d2, ø [mm]	arc [°]	H [cm]	Z1 [cm]	Z2 [cm]	Z3 [cm]	Z4 [cm]	Z5 [cm]
390.470.14.1	90 / 90 / 50	90	90	50	90	30,6	3,2	10,9	5,2	4,9	6,7
390.570.14.1	100 / 90 / 50	110	90	50	90	32,4	3,3	11,1	5,4	5,9	7,8
390.578.14.1	100 / 100 / 50	110	110	50	90	35	3,3	12,6	6,5	5,9	7,4
390.561.14.1	100 / 100 / 70	110	110	75	90	37,5	4,2	13,8	6,5	6	7,8

Geberit Silent-PP kombi-bendhjørnegren 87,5° høyre

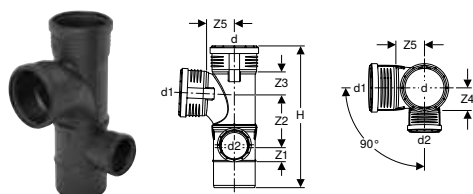

click & scan

Art. nr.	DN	d, ø [mm]	d1, ø [mm]	d2, ø [mm]	arc [°]	H [cm]	Z1 [cm]	Z2 [cm]	Z3 [cm]	Z4 [cm]	Z5 [cm]
390.462.14.1	90 / 90 / 50	90	90	50	90	30,6	3,2	10,9	5,2	4,9	6,7
390.562.14.1	100 / 90 / 50	110	90	50	90	32,4	3,3	11,1	5,4	5,9	7,8
390.565.14.1	100 / 100 / 50	110	110	50	90	35	3,3	12,6	6,5	5,9	7,4
390.560.14.1	100 / 100 / 70	110	110	75	90	37,5	4,2	13,8	6,5	6	7,8

Geberit Silent-PP sjaktgrenrør 87,5° venstre

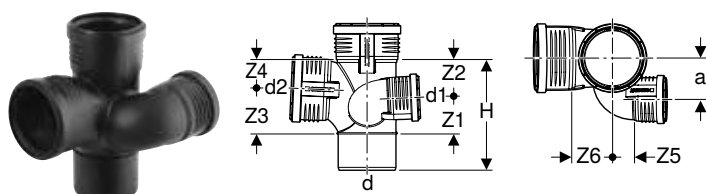

click & scan

Art. nr.	NRF nr.	DN	d, ø [mm]	d1, ø [mm]	d2, ø [mm]	a [cm]	H [cm]	Z1 [cm]	Z2 [cm]	Z3 [cm]	Z4 [cm]	Z5 [cm]	Z6 [cm]
390.464.14.1	2294729	90 / 70 / 90	90	75	90	8,2	17,6	6,3	5,3	6,7	4,9	3,5	6,9
390.564.14.1	2294771	100 / 70 / 100	110	75	110	9,2	21,1	6,7	7,6	8,2	6,1	4,4	7,7

Geberit Silent-PP sjaktgrenrør 87,5° høyre

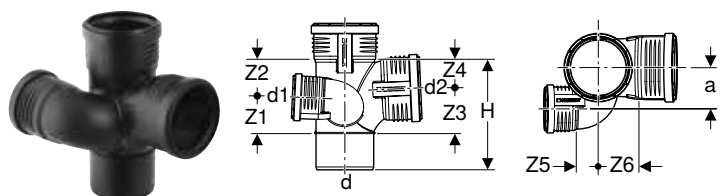

click & scan

Art. nr.	NRF nr.	DN	d, ø [mm]	d1, ø [mm]	d2, ø [mm]	a [cm]	H [cm]	Z1 [cm]	Z2 [cm]	Z3 [cm]	Z4 [cm]	Z5 [cm]	Z6 [cm]
390.463.14.1	2294728	90 / 70 / 90	90	75	90	8,2	17,6	6,3	5,3	6,7	4,9	3,5	6,9
390.563.14.1	2294769	100 / 70 / 100	110	75	110	9,2	21,1	6,7	7,6	8,2	6,1	4,4	7,7

Geberit Silent-PP parallellgren 45°

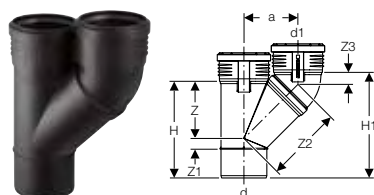

click & scan

Art. nr.	NRF nr.	DN	d, ø [mm]	d1, ø [mm]	arc [°]	a [cm]	H [cm]	H1 [cm]	Z [cm]	Z1 [cm]	Z2 [cm]	Z3 [cm]
390.457.14.1	2294726	90 / 90	90	90	45	11	19,6	21,4	11,3	2,2	15	2,5
390.557.14.1	2294767	100 / 100	110	110	45	13	23,3	25,5	13,8	2,7	18,4	2,9

Reduksjoner

Geberit Silent-PP eksentrisk reduksjon, kort

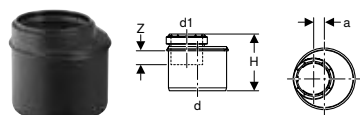

click & scan

Art. nr.	DN	d, ø [mm]	d1, ø [mm]	a [cm]	H [cm]	Z [cm]
390.373.14.1	70 / 50	75	50	1	8,4	2,3
390.474.14.1	90 / 50	90	50	1,7	8,8	2,4
390.475.14.1	90 / 70	90	75	0,4	8,9	2,8
390.575.14.1	100 / 50	110	50	2,6	9,5	2,4
390.576.14.1	100 / 70	110	75	1,4	9,6	2,9
390.577.14.1	100 / 90	110	90	0,6	9,8	3,2



Geberit Silent-PP eksentrisk reduksjon

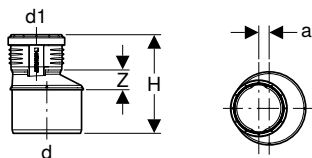

click & scan

Art. nr.	NRF nr.	DN	d, ø [mm]	d1, ø [mm]	a [cm]	H [cm]	Z [cm]
390.271.14.1	2294664	50 / 40	50	40	0,5	11,4	1,6
390.279.14.1	2294666	50 / 30	50	32	0,9	11,3	1,9
390.372.14.1	2294699	70 / 50	75	50	1,2	13,3	2,6
390.471.14.1	2294733	90 / 40	90	40	2,4	14,6	3,8
390.472.14.1	2294734	90 / 50	90	50	1,9	14,6	3,4
390.473.14.1	2294735	90 / 70	90	75	0,7	13,9	2,2
390.571.14.1	2294775	100 / 40	110	40	3,3	16,4	4,9
390.572.14.1	2294776	100 / 50	110	50	2,8	16,4	4,5
390.573.14.1	2294777	100 / 70	110	75	1,7	15,7	3,3
390.574.14.1	2294778	100 / 90	110	90	1	15,7	2,7
390.675.14.1	2294809	125 / 100	125	110	0,7	17,1	2,9
390.775.14.1	2294834	150 / 100	160	110	2,3	19,4	4,5
390.776.14.1	2294835	150 / 125	160	125	1,7	19,4	4

Geberit Silent-PP sentrisk reduksjon, kort

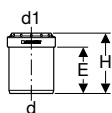

click & scan

Art. nr.	NRF nr.	DN	d, ø [mm]	d1, ø [mm]	E [cm]	H [cm]
390.179.14.1	2294636	40 / 30	40	32	5	6,8
390.278.14.1	2294665	50 / 40	50	40	5,2	6,8

Geberit Silent-PP reduksjonsbend 87,5°

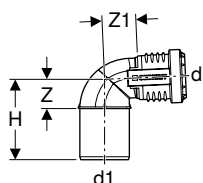

click & scan

Art. nr.	NRF nr.	DN	d, ø [mm]	d1, ø [mm]	H [cm]	Z [cm]	Z1 [cm]
390.225.14.1	2294655	40 / 50	40	50	8,1	3,1	3,5



- Art. nr. 390.325.14.1 er et sveiset formstykke

Stakeluker

Geberit Silent-PP stakeluke 90° med rund serviceåpning

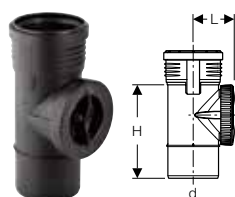

click & scan

Art. nr.	NRF nr.	DN	d, ø [mm]	arc [°]	L [cm]	H [cm]
390.227.14.1	2294656	50	50	90	4,7	12,3
390.327.14.1	2294691	70	75	90	6,1	15,4
390.427.14.1	2294717	90	90	90	7,4	17,7
390.527.14.1	2294754	100	110	90	9	21
390.627.14.1	2294798	125	125	90	9,8	21,5
390.727.14.1	2294825	150	160	90	11,6	22,2

Geberit Silent-PP stakeluke 90° med oval serviceåpning

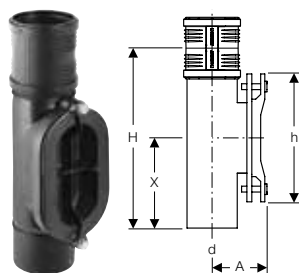

click & scan

Art. nr.	DN	d, ø [mm]	arc [°]	A [cm]	H [cm]	h [cm]	X [cm]
390.503.14.1	100	110	90	12	40,3	28	20
390.603.14.1	125	125	90	12,5	41,4	28	20,5
390.703.14.1	150	160	90	14	43,4	28	21,5

Forbindelser

Muffer

Geberit Silent-PP ekspansjonsmuffe

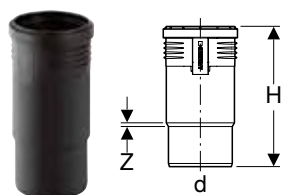

click & scan

Art. nr.	NRF nr.	DN	d, ø [mm]	H [cm]	Z [cm]
390.118.14.1	2294625	40	40	16,8	0,1
390.218.14.1	2294648	50	50	18,1	0,3
390.318.14.1	2294684	70	75	19,8	0,6
390.418.14.1	2294711	90	90	21,7	0,3
390.518.14.1	2294747	100	110	24,2	0,5
390.618.14.1	2294792	125	125	26,5	0,6
390.718.14.1	2294818	150	160	29	0,6

Geberit Silent-PP dobbelstikkmuffe

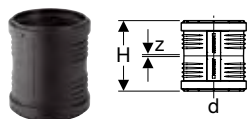

click & scan

Art. nr.	NRF nr.	DN	d, ø [mm]	H [cm]	Z [cm]
390.016.14.1	2294605	30	32	9	0,1
390.116.14.1	2294623	40	40	9,6	0,1
390.216.14.1	2294646	50	50	10,3	0,1
390.316.14.1	2294682	70	75	11,3	0,2
390.416.14.1	2294708	90	90	12,4	0,2
390.516.14.1	2294745	100	110	13,9	0,3
390.616.14.1	2294789	125	125	15,2	0,4
390.716.14.1	2294816	150	160	16,5	0,4

Geberit Silent-PP glidemuffe

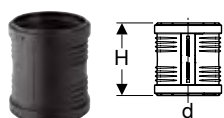

click & scan

Art. nr.	NRF nr.	DN	d, ø [mm]	H [cm]
390.017.14.1	2294606	30	32	9
390.117.14.1	2294624	40	40	9,6
390.217.14.1	2294647	50	50	10,3
390.317.14.1	2294683	70	75	11,3
390.417.14.1	2294709	90	90	12,4
390.517.14.1	2294746	100	110	13,9
390.617.14.1	2294791	125	125	15,2
390.717.14.1	2294817	150	160	16,5

Kloforbindelser

Geberit holdeklo

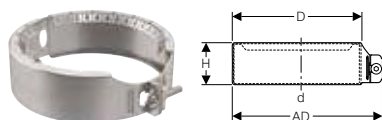

click & scan

Art. nr.	NRF nr.	DN	d, ø [mm]	AD min. [cm]	D [cm]	H [cm]
390.008.14.1		30	32	5,7	4,5	3,3
390.108.14.1		40	40	6,9	5,7	3,5
390.203.14.1	2293911	50	50	8,2	7	3,8
390.308.14.1	2293912	70	75	10,9	9,6	3,7
390.408.14.1	2293913	90	90	12,6	11,3	4,1
390.508.14.1	2293914	100	110	14,7	13,5	4,1
390.608.14.1	2293915	125	125	16,5	15,2	4,5
390.708.14.1	2293916	150	160	20,6	19,3	5

Overganger til andre materialer

Geberit overgangsmansjett på støpejern

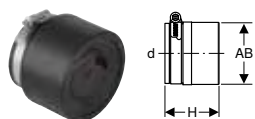

click & scan

Art. nr.	NRF nr.	DN	d, ø [mm]	AB [mm]	H [cm]
390.295.14.1	2294674	40 / 50	58	40-56	6,3
390.395.14.1	2294701	56 / 70	78	56-75	7,7
390.495.14.1	2294737	70 / 80 / 90	83	75-90	7,7
390.595.14.1	2294782	100	110	104-110	9,5
390.695.14.1	2294811	125	135	125	10,3

Geberit overgangsmansjett på støpejern



click & scan

Art. nr.	DN	d, ø [mm]	d1, ø [mm]
367.009.16.1	90 / 100	90	110

Geberit Silent-PP reduksjonsmuffe på Geberit Silent-db20

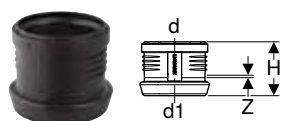

click & scan

Art. nr.	NRF nr.	DN	d, ø [mm]	d1, ø [mm]	H [cm]	Z [cm]
390.296.14.1	2294675	50 / 56	50	56	8,7	0,3
390.396.14.1	2294702	70 / 70	75	75	9,2	0,3
390.496.14.1	2294738	90 / 90	90	90	9,7	0,3
390.596.14.1	2294783	100 / 100	110	110	10,4	0,3
390.696.14.1	2294812	125 / 125	125	135	12	0,3
390.796.14.1	2294836	150 / 150	160	160	13,6	0,4



Utstyrstilkoblinger

Tilslutningsbender

Geberit Silent-PP tilslutningsbend 90°

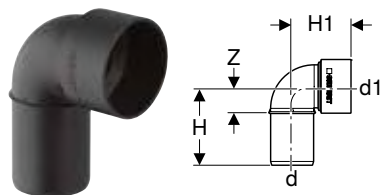

click & scan

Art. nr.	NRF nr.	DN	d, ø [mm]	d1, ø [mm]	H [cm]	H1 [cm]	Z [cm]
390.083.14.1	2294616	30	32	46	7,1	5,1	2,6
390.183.14.1	2294638	40	40	46	7,4	5,5	2,6
390.283.14.1	2294668	50	50	46	8,2	5,7	3,2
390.284.14.1	2294669	50	50	58	8,3	5,9	3,2

Bestilles i tillegg

- Pakningsring

Tilbehør

- Geberit pakningsring → s. 203
- Geberit pakningsring → s. 203

Geberit Silent-PP tilslutningsbend 90° lang

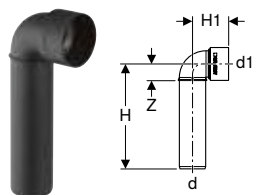

click & scan

Art. nr.	NRF nr.	DN	d, ø [mm]	d1, ø [mm]	H [cm]	H1 [cm]	Z [cm]
390.186.14.1	2294639	40	40	46	16	5,5	11,3

Bestilles i tillegg

- Pakningsring

Tilbehør

- Geberit pakningsring → s. 203

Geberit Silent-PP tilslutningsbend 90° forlenget

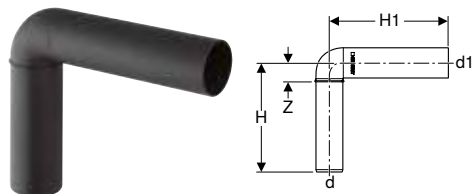

click & scan

Art. nr.	NRF nr.	DN	d, ø [mm]	d1, ø [mm]	H [cm]	H1 [cm]	Z [cm]
390.286.14.1	2294671	50	50	46	16	20	10,9
390.287.14.1	2294672	50	50	58	16	20	10,9

Tilbehør

- Geberit pakningsring → s. 203
- Geberit pakningsring → s. 203

Geberit Silent-PP dobbelgren 90° forlenget

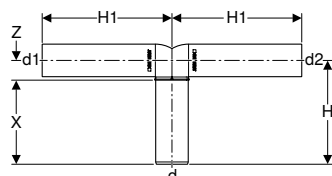

click & scan

Art. nr.	NRF nr.	DN	d, ø [mm]	d1, ø [mm]	d2, ø [mm]	arc [°]	H [cm]	H1 [cm]	X [cm]	Z [cm]
390.289.14.1	2294673	50 / 40 / 40	50	46	46	90	16	20	10,9	5,1

Tilbehør

- Geberit pakningsring → s. 203
- Geberit pakningsring → s. 203

Geberit Silent-PP tilslutningsbend 87,5° for toalett

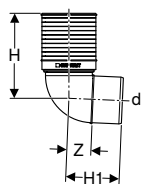

click & scan

Art. nr.	NRF nr.	Farge / overflate	DN	d, ø [mm]	H [cm]	H1 [cm]	Z [cm]
390.493.11.1	2294736	Alpehvit	90	90	20	12,6	5,8
390.593.11.1	2294781	Alpehvit	100	110	19,1	11	4,9

Tilkoblingsrør

Geberit Silent-PP muffe

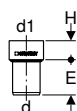

click & scan

Art. nr.	NRF nr.	DN	d, ø [mm]	d1, ø [mm]	E [cm]	H [cm]
390.080.14.1	2294615	30	32	46	4,5	3,5
390.180.14.1	2294637	40	40	46	4,7	3,2
390.281.14.1	2294667	50	50	58	5,1	3,2

Bestilles i tillegg

- Pakningsring

Tilbehør

- Geberit pakningsring → s. 203

Geberit Silent-PP tilkoblingsrør for toalett

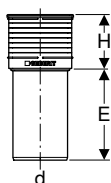

click & scan

Art. nr.	NRF nr.	Farge / overflate	DN	d, ø [mm]	E [cm]	H [cm]
390.592.11.1	2294779	Alpehvit	100	110	18	10,9

Tilbehør

Klammer

Geberit Silent-PP overgangsnippel M10 til G 1/2"

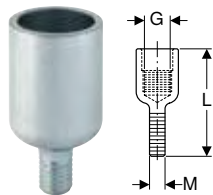

click & scan

Art. nr.	NRF nr.	Farge / overflate	G ["]	M [mm]	L [cm]
390.798.26.1	2294837	El-forsinket	1/2"	10	5,2

Geberit Silent-PP klammer isolert, med gjenget rørmuffe M8/M10

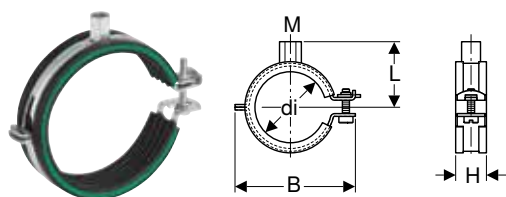

click & scan

Art. nr.	NRF nr.	Farge / overflate	DN	M [mm]	di, ø [mm]	L [cm]	B [cm]	H [cm]
390.099.26.1	2294617	El-forsinket	30	8 / 10	32	4	7,1	2,3
390.199.26.1	2294641	El-forsinket	40	8 / 10	40	4,2	7,7	2,3
390.299.26.1	2294676	El-forsinket	50	8 / 10	50	4,8	8,8	2,3
390.399.26.1	2294703	El-forsinket	70	8 / 10	75	6,2	12,6	2,8
390.499.26.1	2294739	El-forsinket	90	8 / 10	90	6,8	13,7	2,8
390.599.26.1	2294784	El-forsinket	100	8 / 10	110	7,7	15,6	2,8
390.699.26.1	2294813	El-forsinket	125	8 / 10	125	8,9	17,4	2,8
390.799.26.1	2294838	El-forsinket	150	8 / 10	160	10,6	21,2	2,8

Endedeksler

Geberit Silent-PP muffeplugg



click & scan

Art. nr.	NRF nr.	DN	d, ø [mm]	H [cm]
390.128.14.1	2294632	40	40	4,1
390.228.14.1	2294657	50	50	4,7
390.328.14.1	2294692	70	75	5,4
390.428.14.1	2294718	90	90	6
390.528.14.1	2294755	100	110	6,6
390.628.14.1	2294799	125	125	7,3
390.728.14.1	2294826	150	160	7,9

Pakninger

Geberit leppetetning i EPDM



click & scan

Art. nr.	NRF nr.	DN	d, ø [mm]
242.278.00.1		30	32
241.785.00.1		40	40
241.786.00.1		50	50
241.787.00.1		70	75
241.790.00.1		90	90
241.791.00.1	2293894	100	110
242.279.00.1		125	125
242.280.00.1		150	160

Geberit pakningsring



click & scan

Art. nr.	NRF nr.	d, ø [mm]	d1, ø [mm]	L [cm]
152.796.00.1	2291114	40	44	2,3
152.495.00.1	2291113	32	46	2,3
152.496.00.1	2291115	40	46	2,3
153.564.16.1	2291112	32	58	2,3
153.565.16.1	2291116	40	58	2,3
153.566.16.1	2291122	50	58	2,3

Geberit pakningsring

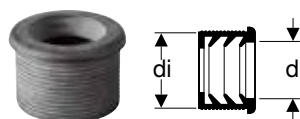

click & scan

Art. nr.	NRF nr.	DN	d, ø [mm]	di, ø [mm]
152.682.00.1		50	32	44
152.689.00.1	2294466	56	32	50
152.690.00.1	2294469	56	40	50
152.691.00.1	2294473	60	32	57
152.692.00.1	2294476	60	40	57
152.693.00.1	2294479	60	50	57

Forbruksmateriell

Geberit glidemiddel 250 ml



[click & scan](#)

Art. nr.	NRF nr.
953.761.00.1	2293918

Geberit markeringspenn med justerbar fettstift



[click & scan](#)

Art. nr.	Farge / overflate
690.102.00.1	Gul

Tilbehør

- Geberit reserve fettstift for markeringspenn med justerbar fettstift → s. 187

Geberit reserve fettstift for markeringspenn med justerbar fettstift



[click & scan](#)

Art. nr.	Farge / overflate
690.103.00.1	Gul





Geberit Silent-db20

Rør	208
Formstykker	208
Bend	208
Grenrør	210
Reduksjoner	212
Stakeluker	213
Forbindelser	213
Sveiseforbindelser	213
Ekspansjonsmuffer	214
Kromstålkoblinger	214
Overganger til andre materialer	215
Utstyrstilkoblinger	216
Tilslutningsbender	216
Tilkoblingsmuffer	216
Tilbehør	217
Klammer	217
Fester for klammer	217
Endedeksler	218
Pakninger	218
Forbruksmateriell	219



Rør

Geberit Silent-db20 rør

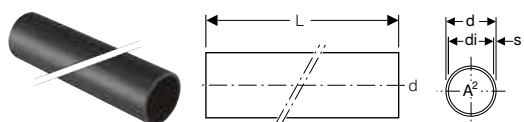

click & scan

Art. nr.	NRF nr.	DN	d, ø [mm]	di, ø [mm]	s [mm]	L [m]	A ² [cm ²]
305.000.14.1	2294006	56	56	49,6	3,2	3	19,3
306.000.14.1		60	63	56,6	3,2	3	25,1
307.000.14.1	2294009	70	75	67,8	3,6	3	36,1
308.000.14.1	2294013	90	90	79	5,5	3	49
310.000.14.1	2294016	100	110	98	6	3	75,4
312.000.14.1	2294018	125	135	123	6	3	118,7
315.001.14.1		150	160	146	7	3	167,4

Formstykker

Bend

Geberit Silent-db20 bend

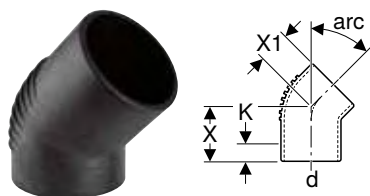

click & scan

Art. nr.	NRF nr.	DN	d, ø [mm]	X [cm]	X1 [cm]	K [cm]
arc / Vinkel: 15°						
305.150.14.1	2294046	56	56	7,5	4,5	3,5
307.150.14.1	2294049	70	75	8	5	3,5
308.150.14.1	2294053	90	90	10	5,5	5,5
310.150.14.1	2294056	100	110	10	6	5,5
312.150.14.1	2294058	125	135	11,5	6,5	6,5
arc / Vinkel: 30°						
305.300.14.1	2294076	56	56	7,5	4,5	3,5
307.300.14.1	2294079	70	75	8	5	3,5
308.300.14.1	2294083	90	90	10	6,5	4,5
310.300.14.1	2294086	100	110	10	6	4,5
312.300.14.1	2294888	125	135	11,5	6,5	6
315.300.14.1		150	160	15,7	15,7	7
arc / Vinkel: 45°						
305.450.14.1	2294096	56	56	7,5	4,5	3
306.450.14.1		60	63	7,5	5	2,5
307.450.14.1	2294099	70	75	8	5	2,5
308.450.14.1	2294103	90	90	10	5,5	4
310.450.14.1	2294106	100	110	10	6	4
312.450.14.1	2294108	125	135	11,5	7,7	5
315.450.14.1		150	160	15,5	9,5	8
arc / Vinkel: 67°						
305.670.14.1	2294126	56	56	7,5	5,5	2
307.670.14.1	2294129	70	75	8	6	2
308.670.14.1	2294133	90	90	10	7	3
310.670.14.1	2294136	100	110	10	8	2,5

Geberit Silent-db20 bend med langt tilkoblingsrør

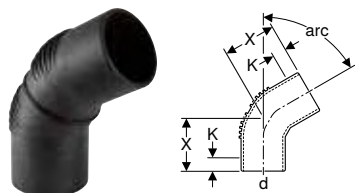

click & scan

Art. nr.	DN	d, ø [mm]	X [cm]	K [cm]
arc / Vinkel: 60°				
305.600.14.1	56	56	9,1	3,5
307.600.14.1	70	75	11,3	3,5
308.600.14.1	90	90	13,8	4,5
310.600.14.1	100	110	14,6	4,5
312.600.14.1	125	135	16,9	6
arc / Vinkel: 88,5°				
312.885.14.1	125	135	18,6	5
315.885.14.1	150	160	22,5	8

Geberit Silent-db20 bend 88,5°

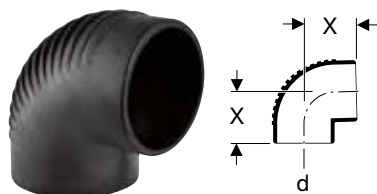

click & scan

Art. nr.	NRF nr.	DN	d, ø [mm]	X [cm]
305.880.14.1	2294156	56	56	6,5
306.880.14.1		60	63	7
307.880.14.1	2294159	70	75	7,5
308.880.14.1	2294163	90	90	8
310.880.14.1	2294166	100	110	9,5
312.880.14.1	2294168	125	135	11,5

Geberit Silent-db20 bend 45° med langt tilkoblingsrør

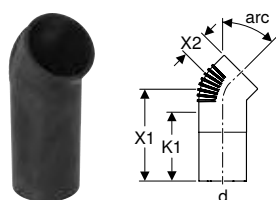

click & scan

Art. nr.	NRF nr.	DN	d, ø [mm]	X1 [cm]	X2 [cm]	K1 maks. [cm]
308.014.14.1	2294026	90	90	21	5,5	15,5
310.014.14.1	2294027	100	110	21	6	15
312.014.14.1	2294028	125	135	22,5	7,7	16

Geberit Silent-db20 forskyvningsfitting

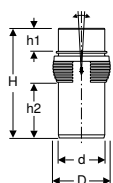

click & scan

Art. nr.	Farge / overflate	DN	d, ø [mm]	D [cm]	H [cm]	h2 [cm]	h1 [cm]
310.048.14.1	Mattsvart	100	110	13,6	26	13	5,3

Grenrør

Geberit Silent-db20 grenrør 45°

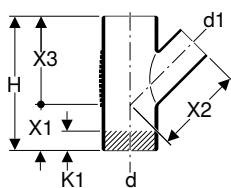

click & scan

Art. nr.	NRF nr.	DN	d, ø [mm]	d1, ø [mm]	arc [°]	H [cm]	X1 [cm]	X2 [cm]	X3 [cm]	K1 maks. [cm]
305.054.14.1	2294206	56 / 56	56	56	45	18	6	12	12	1,5
306.054.14.1		60 / 56	63	56	45	19,5	6,5	13	13	2
306.064.14.1		60 / 60	63	63	45	19,5	6,5	13	13	2
307.054.14.1	2294209	70 / 56	75	56	45	21	7	14	14	3,5
307.074.14.1	2294213	70 / 70	75	75	45	21	7	14	14	2
308.054.14.1	2294216	90 / 56	90	56	45	24	8	16	16	5
308.074.14.1	2294219	90 / 70	90	75	45	24	8	16	16	4
308.084.14.1	2294223	90 / 90	90	90	45	24	8	16	16	2,5
310.054.14.1	2294226	100 / 56	110	56	45	27	9	18	18	7
310.074.14.1	2294229	100 / 70	110	75	45	27	9	18	18	5,5
310.084.14.1	2294233	100 / 90	110	90	45	27	9	18	18	4,5
310.104.14.1	2294236	100 / 100	110	110	45	27	9	18	18	3
312.104.14.1	2294238	125 / 100	135	110	45	34,5	11,5	23	23	6,5
312.124.14.1	2294241	125 / 125	135	135	45	34,5	11,5	23	23	5
315.144.14.1		150 / 150	160	160	45	41,5	14	27,5	27,5	7

Geberit Silent-db20 grenrør 45°

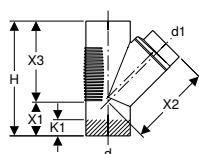

click & scan

Art. nr.	DN	d, ø [mm]	d1, ø [mm]	arc [°]	H [cm]	X1 [cm]	X2 [cm]	X3 [cm]	K1 maks. [cm]
315.104.14.1	150 / 100	160	110	45	41,5	10,6	30	30,9	7
315.124.14.1	150 / 125	160	135	45	41,5	12,4	29,7	29,1	7

Geberit Silent-db20 bendgren 88,5°

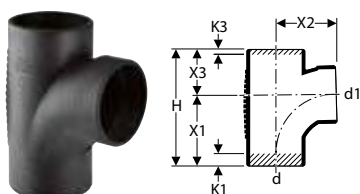

click & scan

Art. nr.	NRF nr.	DN	d, ø [mm]	d1, ø [mm]	arc [°]	H [cm]	X1 [cm]	X2 [cm]	X3 [cm]	K1 maks. [cm]	K3 maks. [cm]
308.089.14.1		90 / 90	90	90	88,5	20,4	12	10,5	8,3	1,5	0,5
310.088.14.1	2294283	100 / 90	110	90	88,5	22,5	13,5	11,5	9	4	1
310.108.14.1	2294286	100 / 100	110	110	88,5	22,5	13,5	11,5	9	2,5	0
312.109.14.1		125 / 100	135	110	88,5	22,6	13,5	11,5	9,1	2,5	0

Geberit Silent-db20 grenrør 88,5°

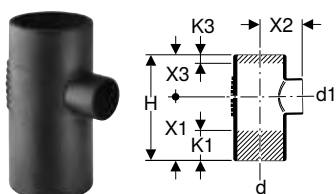

click & scan

Art. nr.	NRF nr.	DN	d, ø [mm]	d1, ø [mm]	arc [°]	H [cm]	X1 [cm]	X2 [cm]	X3 [cm]	K1 maks. [cm]	K3 maks. [cm]
305.058.14.1	2294256	56 / 56	56	56	88,5	17,5	10,5	7	7	4,5	0,5
307.058.14.1	2294259	70 / 56	75	56	88,5	18	10,5	7	7,5	4,5	0,5
307.078.14.1	2294263	70 / 70	75	75	88,5	18	10,5	7,5	7,5	3,5	0
308.058.14.1	2294266	90 / 56	90	56	88,5	20,3	12	8	8,3	6	2
308.078.14.1	2294269	90 / 70	90	75	88,5	20,3	12	8	8,3	5	1
308.088.14.1	2294273	90 / 90	90	90	88,5	20,3	12	8,3	8,3	4,5	0,5
310.058.14.1	2294276	100 / 56	110	56	88,5	22,5	13,5	9	9	7,5	3
310.078.14.1	2294279	100 / 70	110	75	88,5	22,5	13,5	9	9	6,5	1,5
312.108.14.1	2294287	125 / 100	135	110	88,5	28,8	17,3	11,5	11,5	8,5	2,5
312.128.14.1	2294288	125 / 125	135	135	88,5	28,8	17,3	11,5	11,5	7,5	1,5
315.148.14.1		150 / 150	160	160	88,5	33,5	18,5	15	15	7	3

Geberit Silent-db20 grenrør 88,5°

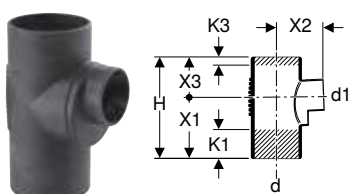

click & scan

Art. nr.	DN	d, ø [mm]	d1, ø [mm]	arc [°]	H [cm]	X1 [cm]	X2 [cm]	X3 [cm]	K1 maks. [cm]	K3 maks. [cm]
315.108.14.1	150 / 100	160	110	88,5	33,5	21	15	12,5	7	1,5
315.128.14.1	150 / 125	160	135	88,5	33,5	19,5	16	14	7	1,5

Geberit Silent-db20 bendgren 88,5° dobbelt

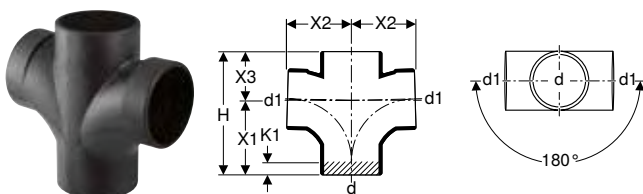

click & scan

Art. nr.	NRF nr.	DN	d, ø [mm]	d1, ø [mm]	H [cm]	X1 [cm]	X2 [cm]	X3 [cm]	K1 maks. [cm]
310.102.14.1	2294306	100	110	110	22,5	13,5	11,5	9	2,5

Geberit Silent-db20 kombi-bendhjørnegren 88,5° venstre

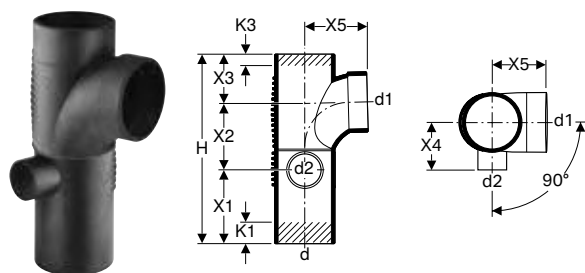

click & scan

Art. nr.	DN	d, ø [mm]	d1, ø [mm]	d2, ø [mm]	H [cm]	X1 [cm]	X2 [cm]	X3 [cm]	X4 [cm]	X5 [cm]	K1 maks. [cm]	K3 maks. [cm]
308.817.14.1	90 / 90 / 56	90	90	56	31,6	12	11,3	8,3	8	10,5	6	0,5
310.817.14.1	100 / 90 / 56	110	90	56	33,8	13,5	11,3	9	9	11,5	7,5	1
310.117.14.1	100 / 100 / 56	110	110	56	34,8	13,5	12,3	9	9	11,5	7,5	0

Geberit Silent-db20 kombi-bendhjørnegren 88,5° høyre

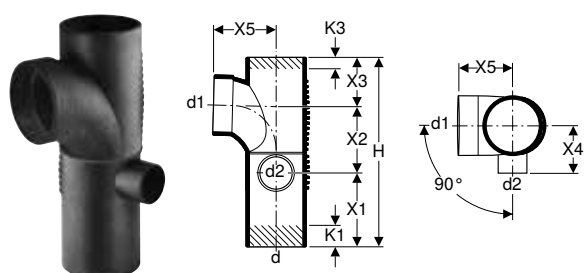

click & scan

Art. nr.	DN	d, ø [mm]	d1, ø [mm]	d2, ø [mm]	H [cm]	X1 [cm]	X2 [cm]	X3 [cm]	X4 [cm]	X5 [cm]	K1 maks. [cm]	K3 maks. [cm]
308.815.14.1	90 / 90 / 56	90	90	56	31,6	12	11,3	8,3	8	10,5	6	0,5
310.815.14.1	100 / 90 / 56	110	90	56	33,8	13,5	11,3	9	9	11,5	7,5	1
310.115.14.1	100 / 100 / 56	110	110	56	34,8	13,5	12,3	9	9	11,5	7,5	0

Geberit Silent-db20 parallellgren 45°

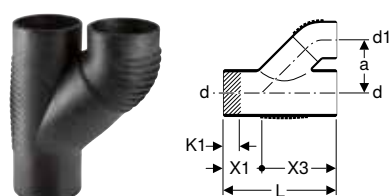

click & scan

Art. nr.	NRF nr.	DN	d, ø [mm]	d1, ø [mm]	arc [°]	a [cm]	L [cm]	X1 [cm]	X2 [cm]	X3 [cm]	K1 maks. [cm]
308.081.14.1	2294316	90 / 90	90	90	45	11	24	8	16	16	2,5
310.081.14.1	2294319	100 / 90	110	90	45	12,5	27	9	18	18	4,5
310.101.14.1	2294323	100 / 100	110	110	45	12,5	27	9	18	18	3

Reduksjoner

Geberit Silent-db20 eksentrisk reduksjon, kort

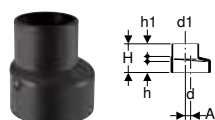

click & scan

Art. nr.	NRF nr.	DN	d, ø [mm]	d1, ø [mm]	A [cm]	H [cm]	h [cm]	h1 [cm]
307.050.14.1	2294386	70 / 56	75	56	0,9	8	3,3	3,7
307.060.14.1		70 / 60	75	63	0,6	8	3,3	3,7
308.050.14.1	2294389	90 / 56	90	56	1,5	8	3,1	3,7
308.070.14.1	2294393	90 / 70	90	75	0,6	8	3,3	3,7

Geberit Silent-db20 eksentrisk reduksjon

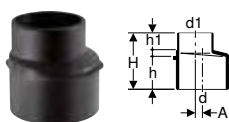

click & scan

Art. nr.	NRF nr.	DN	d, ø [mm]	d1, ø [mm]	A [cm]	H [cm]	h [cm]	h1 [cm]
310.050.14.1	2294396	100 / 56	110	56	2,4	11	6	3,7
310.070.14.1	2294399	100 / 70	110	75	1,5	11	6	3,7
310.080.14.1	2294403	100 / 90	110	90	1	11	6,1	3,7
312.100.14.1	2294405	125 / 100	135	110	1,3	11	6,1	3,7
312.125.14.1		125 / 125	135	125	0,4	11	6	3,7
315.100.14.1		150 / 100	160	110	2,4	12,6	8	3,8
315.126.14.1		150 / 125	160	135	1,1	13,5	8	4,7

Stakeluger

Geberit Silent-db20 stakeluke 90° med rund serviceåpning

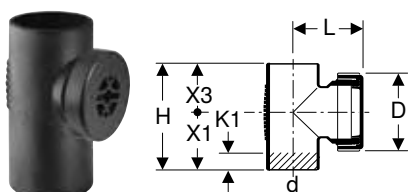

click & scan

Art. nr.	NRF nr.	DN	d, ø [mm]	arc [°]	D [cm]	L [cm]	H [cm]	X1 [cm]	X3 [cm]	K1 maks. [cm]
307.333.14.1	2294336	70	75	90	11,5	10	17,5	10,5	7	3,5
310.334.14.1	2294339	100	110	90	14,5	9	24	13,5	10,5	2,5
312.333.14.1	2294342	125	135	90	14,5	13	28,8	17,3	11,5	8,5
315.333.14.1		150	160	90	14,4	13,9	33,5	18,5	15	7

Forbindelser

Sveiseforbindelser

Geberit elektro-sveisemuffe



click & scan

Art. nr.	NRF nr.	DN	d, ø [mm]	D [cm]	E [cm]	H [cm]	X [cm]
363.771.16.1	2292471	56	56	6,8	2,8	6	0,3
364.771.16.1	2292473	60	63	7,6	2,8	6	0,3
365.771.16.1	2292475	70	75	8,9	2,8	6	0,3
366.771.16.1	2292477	90	90	10,4	2,8	6	0,3
367.771.16.1	2292479	100	110	12,5	2,8	6	0,3
312.771.16.1	2292483	125	135	15	2,8	6	0,3
369.771.16.1	2292484	150	160	17,8	2,8	6	0,3

Ekspansjonsmuffer

Geberit Silent-db20 ekspansjonsmuffe med klammerspor

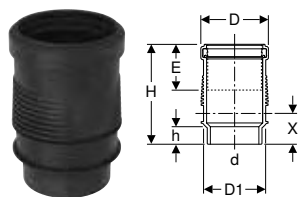

click & scan

Art. nr.	NRF nr.	DN	d, ø [mm]	D [cm]	D1 [cm]	E [cm]	H [cm]	h [cm]	X [cm]
307.012.14.1	2294371	70	75	9,8	9	8,8	20	3,7	6,2
308.012.14.1	2294373	90	90	11,4	11	8,8	20	3,4	6,2
310.012.14.1	2294375	100	110	13,5	12,5	9	20	3,3	6,2
312.012.14.1		125	135	16,8	16	9,5	20,8	3,3	6,2
315.012.14.1		150	160	19,5	17,8	9,8	21,5	3,5	7,1



- Målet til innstikksdybden (E) gjelder for en monteringsstemperatur på 20 °C

Geberit Silent-db20 ekspansjonsmuffe



click & scan

Art. nr.	NRF nr.	DN	d, ø [mm]	D [cm]	D1 [cm]	E [cm]	E1 [cm]	H [cm]	X [cm]
305.002.14.1	2294356	56	56	8	6,3	6	3,5	10,8	1,3
306.002.14.1		60	63	8,7	7,5	6	3,5	10,8	1,3
307.002.14.1	2294359	70	75	10	9	6	3,5	10,8	1,3
308.002.14.1	2294363	90	90	11,4	11	6,3	3,5	11,1	1,3
310.002.14.1	2294366	100	110	13,4	12,5	6,3	3,5	11,1	1,3
312.002.14.1	2294368	125	135	17	16	6,6	4,3	12,2	1,3
315.002.14.1		150	160	19,2	17,8	7	5,2	13,5	1,3

Kromstålkoblinger

Geberit Silent-db20 kromstålkobling

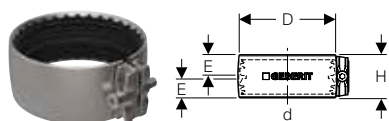

click & scan

Art. nr.	NRF nr.	DN	d, ø [mm]	D [cm]	E [cm]	H [cm]
305.003.14.3	2294019	56	56	6,7	2,4	5,2
307.003.14.3	2294021	70	75	8,6	2,4	5,2
308.003.14.3	2294022	90	90	10,1	2,4	5,2
310.003.14.3	2294506	100	110	12	2,4	5,2
312.003.14.3	2294023	125	135	14,8	3,2	6,7
315.003.14.3	2294024	150	160	17,2	3,2	6,7

Overganger til andre materialer

Geberit Silent-PP reduksjonsmuffe på Geberit Silent-db20

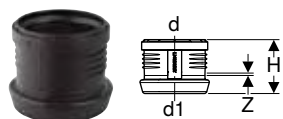

click & scan

Art. nr.	NRF nr.	DN	d, ø [mm]	d1, ø [mm]	H [cm]	Z [cm]
390.296.14.1	2294675	50 / 56	50	56	8,7	0,3
390.396.14.1	2294702	70 / 70	75	75	9,2	0,3
390.496.14.1	2294738	90 / 90	90	90	9,7	0,3
390.596.14.1	2294783	100 / 100	110	110	10,4	0,3
390.696.14.1	2294812	125 / 125	125	135	12	0,3
390.796.14.1	2294836	150 / 150	160	160	13,6	0,4

Geberit kromstålkobling

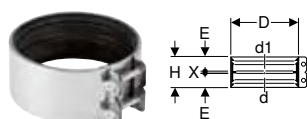

click & scan

Art. nr.	NRF nr.	DN	d, ø [mm]	d1, ø [mm]	D [cm]	E [cm]	H [cm]	X [cm]
359.425.00.2	2293922	50	54-56	54-56	7,5	2,7	5,7	0,3
359.426.00.2	2293923	56	56	58	7,5	2,7	5,7	0,3
359.427.00.2	2293924	56	56	68	8,3	2,7	5,7	0,3
359.428.00.2	2293925	60	63	60	7,8	2,7	5,7	0,3
359.429.00.2	2293926	60	63-64	63-64	7,8	2,7	5,7	0,3
359.430.00.2	2293927	60	63-64	68	8,3	2,7	5,7	0,3
359.432.00.2	2293903	70	75	68	9	2,7	5,7	0,3
359.433.00.2	2293929	70	75-76	75-76	8,8	2,7	5,7	0,3
359.434.00.2	2293931	70	75-76	78	9,3	2,7	5,7	0,3
359.435.00.2	2293932	70	75-76	83-84	9,8	2,7	5,7	0,3
359.436.00.2	2293904	70	75-76	89-90	10,3	2,7	5,7	0,3
359.437.00.2	2293933	90	89-90	83-84	11,1	2,7	5,7	0,3
359.438.00.2	2293905	90	89-90	89-90	10,3	2,7	5,7	0,3
359.439.00.2	2293934	90	89-90	96	11,1	3,3	6,9	0,3
359.440.00.2	2293935	100	108-110	106	12,5	2,7	5,7	0,3
359.441.00.2	2293906	100	108-110	108-110	12,5	2,7	5,7	0,3
359.442.00.2	2293936	100	108-110	114-116	13,1	3,3	6,9	0,3
359.444.00.2	2293907	125	125	131-135	15	3,3	6,9	0,3
359.446.00.2	2293939	125	135	135	15	3,3	6,9	0,3
312.140.00.2	2293919	125	135	140	15,5	3,1	6,9	0,7
359.448.00.2	2293942	150	159-160	152	17,5	3,3	6,9	0,3
359.449.00.2	2293908	150	159-160	159-160	17,5	3,3	6,9	0,3
359.450.00.2	2293943	150	159-160	168	18,3	3,3	6,9	0,3



Utstyrstilkoblinger

Tilslutningsbender

Geberit Silent-db20 tilslutningsbend 90° forlengt

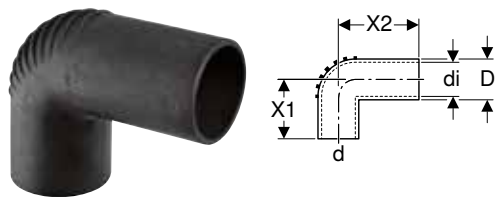

click & scan

Art. nr.	NRF nr.	DN	d, ø [mm]	di, ø [mm]	D [cm]	X1 [cm]	X2 [cm]
305.905.14.1	2294186	56	56	50	5,6	7,5	10
305.906.14.1	2294189	56	56	57	6,3	7,5	20

Tilbehør

- Geberit pakningsring → s. 203
- Geberit pakningsring → s. 203

Geberit Silent-db20 tilslutningsbend 90° forlengt

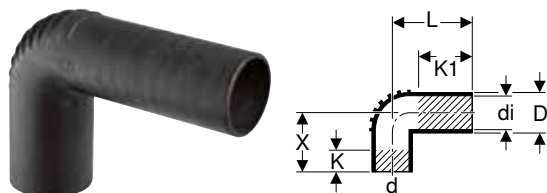

click & scan

Art. nr.	DN	d, ø [mm]	di, ø [mm]	D [cm]	L [cm]	X [cm]	K [cm]	K1 maks. [cm]
305.904.14.1	56	56	46	5,2	15	10	4	10

Tilkoblingsmuffer

Geberit Silent-db20 overgangsmuffe redusert

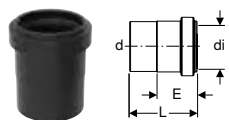

click & scan

Art. nr.	NRF nr.	DN	d, ø [mm]	di, ø [mm]	E [cm]	L [cm]
305.040.14.3	2294025	56 / 50	56	50	4,5	7,6

Tilbehør

Klammer

Geberit Silent-db20 klammer isolert, med gjenget rørmuffe M10 / G 1/2"



click & scan

Art. nr.	NRF nr.	DN	G ["]	M [mm]	di, ø [mm]	L [cm]
305.812.26.1	2294526	56	1/2"	10	56	4,7
306.812.26.1		60	1/2"	10	63	5
307.812.26.1	2294529	70	1/2"	10	75	5,7
308.812.26.1	2294533	90	1/2"	10	90	6,4
310.812.26.1	2294536	100	1/2"	10	110	7,4
312.812.26.1	2294539	125	1/2"	10	125	8,1
312.813.26.1		125	1/2"	10	135	8,7
315.812.26.1		150	1/2"	10	160	9,9

Geberit Silent-db20 klammer isolert, med gjenget rørmuffe G 1"



click & scan

Art. nr.	DN	G ["]	di, ø [mm]	L [cm]
315.813.26.1	150	1"	178	12

Fester for klammer

Geberit bunnplate rektangulær, to hull, med gjenget rørmuffe M10 / G 1/2"

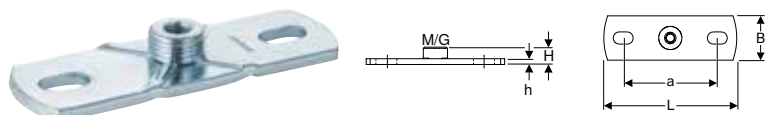

click & scan

Art. nr.	NRF nr.	G ["]	M [mm]	a [cm]	L [cm]	B [cm]	H [cm]	h [cm]
362.851.26.1	2290374	1/2"	10	8,5	12	4	1,5	0,5

Geberit bunnplate rektangulær, to hull, med gjenget rørmuffe G

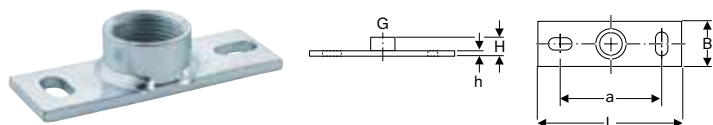

click & scan

Art. nr.	NRF nr.	G ["]	a [cm]	L [cm]	B [cm]	H [cm]	h [cm]
362.828.26.1	2290372	1"	9	12	4	2,6	0,6

Geberit gjengestag



click & scan

Art. nr.	NRF nr.	M [mm]	L [cm]
362.836.00.1	2294555	10	50

Endedeckler

Geberit Silent-db20 lokk for sveising



click & scan

Art. nr.	DN	d, ø [mm]	L [cm]
305.005.14.1	56	56	3
307.005.14.1	70	75	3
308.005.14.1	90	90	3
310.005.14.1	100	110	3
312.005.14.1	125	135	3

Geberit Silent-db20 lokk for sveising, med skrulokk

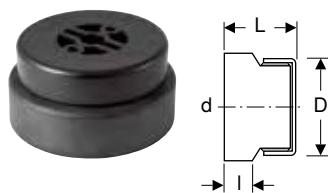

click & scan

Art. nr.	DN	d, ø [mm]	D [cm]	L [cm]	I [cm]
315.005.14.1	150	160	14,4	7,2	3,3

Pakninger

Geberit pakningsring



click & scan

Art. nr.	NRF nr.	d, ø [mm]	d1, ø [mm]	L [cm]
152.796.00.1	2291114	40	44	2,3
152.495.00.1	2291113	32	46	2,3
152.496.00.1	2291115	40	46	2,3
153.564.16.1	2291112	32	58	2,3
153.565.16.1	2291116	40	58	2,3
153.566.16.1	2291122	50	58	2,3

Geberit pakningsring

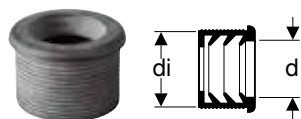

click & scan

Art. nr.	NRF nr.	DN	d, ø [mm]	di, ø [mm]
152.682.00.1		50	32	44
152.689.00.1	2294466	56	32	50
152.690.00.1	2294469	56	40	50
152.691.00.1	2294473	60	32	57
152.692.00.1	2294476	60	40	57
152.693.00.1	2294479	60	50	57

Forbruksmateriell

Geberit glidemiddel 250 ml



[click & scan](#)

Art. nr.	NRF nr.
953.761.00.1	2293918

Geberit markeringspenn med justerbar fettstift



[click & scan](#)

Art. nr.	Farge / overflate
690.102.00.1	Gul

Tilbehør

- Geberit reserve fettstift for markeringspenn med justerbar fettstift → s. 187

Geberit reserve fettstift for markeringspenn med justerbar fettstift



[click & scan](#)

Art. nr.	Farge / overflate
690.103.00.1	Gul





Geberit PE

Rør	222
Formstykker	222
Bend	222
Grenrør	225
Reduksjoner	229
Stakeluker	231
Overganger	231
Spesialformstykker	232
Forbindelser	232
Sveiseforbindelser	232
Ekspansjonsmuffer	233
Overganger til andre materialer	234
Gjengeforbindelser	236
Flensforbindelser	239
Flensbøssinger	241
Utstyrstilkoblinger	241
Tilslutningsbender	241
Tilkoblingsmuffer	244
Tilkoblingsrør	245
Rørbendvannlåser	245
Spiralvannlåser	245
Tilbehør	246
Klammer	246
Fester for klammer	247
Bærende strukturer	250
Endedeksler	251
Pakninger	252
Beskyttelseskapper	255
Forbruksmateriell	255



Rør

Geberit PE rør

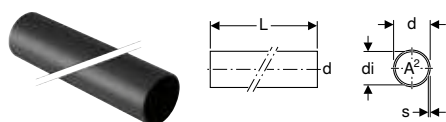

click & scan

Art. nr.	NRF nr.	DN	d, ø [mm]	di, ø [mm]	s [mm]	L [m]	A ² [cm ²]	PN [bar]	S
379.000.16.0	2290004	30	32	26	3	5	5,3	10,3	5
360.000.16.0	2290009	40	40	34	3	5	9	8,1	6,3
361.000.16.0	2290021	50	50	44	3	5	15,2	6,4	8
363.000.16.0	2290026	56	56	50	3	5	19,6	5,7	8,8
364.000.16.0	2290032	60	63	57	3	5	25,4	5	10
365.000.16.0	2290043	70	75	69	3	5	37,3	4,1	12,5
366.000.16.0	2290048	90	90	83	3,5	5	54,1	4	12,5
367.000.16.0	2290053	100	110	101,4	4,3	5	80,7	4	12,5
368.000.16.0	2290065	125	125	115,2	4,9	5	104,5	4	12,5
369.000.16.0	2290071	150	160	147,6	6,2	5	171,1	4	12,5
370.000.16.0	2290076	200	200	187,6	6,2	5	276,4	3,2	16
371.000.16.0	2290082	250	250	234,4	7,8	5	431,5	3,2	16
372.000.16.0	2290087	300	315	295,4	9,8	5	685,3	3,2	16

Formstykker

Bend

Geberit PE bend

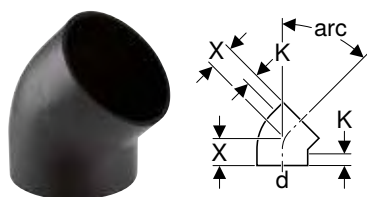

click & scan

Art. nr.	NRF nr.	DN	d, ø [mm]	X [cm]	K [cm]
arc / Vinkel: 45°					
360.045.16.1	2290604	40	40	4	2
361.045.16.1	2290608	50	50	4,5	2
363.045.16.1	2290611	56	56	4,5	2
364.045.16.1	2290613	60	63	5	2
365.045.16.1	2290615	70	75	5	2
366.045.16.1	2290617	90	90	5,5	2
367.045.16.1	2290619	100	110	6	2,5
368.045.16.1	2290622	125	125	6,5	2,5
369.045.16.1	2290624	150	160	6,9	2
370.045.16.1	2290626	200	200	18	2,5
arc / Vinkel: 88,5°					
361.088.16.1	2290558	50	50	6	2
363.088.16.1	2290561	56	56	6,5	2
364.088.16.1	2290563	60	63	7	2
365.088.16.1	2290565	70	75	7,5	2
366.088.16.1	2290567	90	90	8	2
367.088.16.1	2290569	100	110	9,5	2,5
368.088.16.1	2290572	125	125	10	2,5
369.088.16.1	2290574	150	160	12	2,5

Geberit PE bend med langt tilkoblingsrør

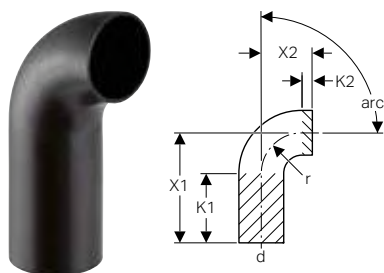

click & scan

Art. nr.	NRF nr.	DN	d, ø [mm]	X1 [cm]	X2 [cm]	K1 maks. [cm]	K2 maks. [cm]	r [cm]
arc / Vinkel: 15°								
367.015.16.1	2290145	100	110	18	7	15,5	4,5	
369.015.16.1	2290149	150	160	7,5	7,5	4,5	4,5	
arc / Vinkel: 30°								
367.030.16.1	2290146	100	110	19,5	8,5	15,5	4,5	
368.030.16.1	2290148	125	125	12	9	7,5	4,5	
369.030.16.1	2290151	150	160	9,5	9,5	4,5	4,5	
arc / Vinkel: 45°								
367.046.16.1	2290147	100	110	14,7	6	11	2,5	
arc / Vinkel: 90°								
379.055.16.1	2290504	30	32	10	3	7		3
360.055.16.1	2290506	40	40	15	3	12		3
361.055.16.1	2290508	50	50	18	4	14		4
363.055.16.1	2290511	56	56	21	4	17		4
364.055.16.1	2290513	60	63	21	5	16		5
365.055.16.1	2290515	70	75	21	7	14		7
366.055.16.1	2290517	90	90	24	9	15		9
367.055.16.1	2290519	100	110	27	10	17		10
368.055.16.1	2290522	125	125	20	11	9		11
369.055.16.1	2290524	150	160	20	14	6		14



- Geberit PE bend med vinklene 15°, 30°, 45° og 88,5° kan sveises på begge leggene med Geberit elektrosveisemuffer
- Geberit PE bend med vinkel 90° kan sveises på den lange leggen med Geberit elektrosveisemuffer

Geberit PE segmentbend

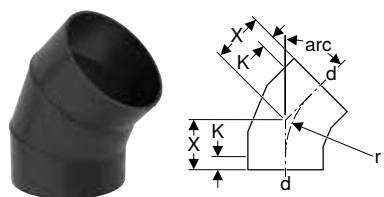

click & scan

Art. nr.	NRF nr.	DN	d, ø [mm]	X [cm]	K [cm]	r [cm]
arc / Vinkel: 15°						
370.015.16.1	2290325	200	200	15,5	4	
371.015.16.1	2290326	250	250	10,3	0	
372.015.16.1	2290327	300	315	10,3	0	
arc / Vinkel: 30°						
370.030.16.1	2290328	200	200	15	2	20
371.030.16.1	2290329	250	250	16	0	42
372.030.16.1	2290331	300	315	17	0	47,3
arc / Vinkel: 45°						
371.045.16.1	2290628	250	250	16,5	0	29
372.045.16.1	2290632	300	315	18	0	32,5
arc / Vinkel: 90°						
370.055.16.1	2290526	200	200	30	2,5	20
371.055.16.1	2290528	250	250	33,5	0	29
372.055.16.1	2290531	300	315	37	0	32,5

Geberit PE bend 90° med langt tilkoblingsrør og liten radius

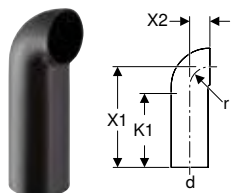

click & scan

Art. nr.	NRF nr.	DN	d, ø [mm]	X1 [cm]	X2 [cm]	K1 maks. [cm]	r [cm]
366.876.16.1	2290152	90	90	27	5	20	5
367.876.16.1		100	110	30	6	22	6

Geberit PE bend 90° redusert, uten tilkoblingsrør

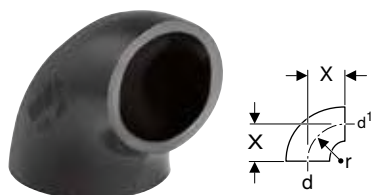

click & scan

Art. nr.	NRF nr.	DN	d, ø [mm]	d1, ø [mm]	X [cm]	r [cm]
361.872.16.1	2290153	50 / 40	50	40	4	4
363.873.16.1	2290154	56 / 50	56	50	4	4
364.873.16.1		60 / 50	63	50	5	5
364.874.16.1	2290155	60 / 56	63	56	5	5

Geberit PE BottomTurn-bend

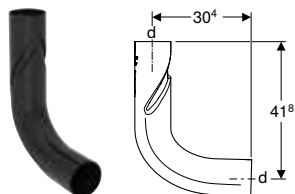

click & scan

Art. nr.	NRF nr.	Farge / overflate	DN	d, ø [mm]
367.615.16.1	2290159	Svart	100	110

Geberit PE BackFlip-bend

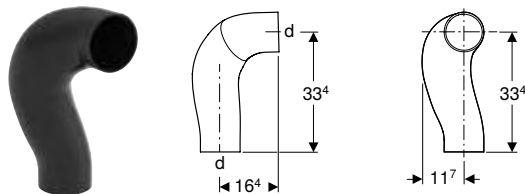

click & scan

Art. nr.	NRF nr.	Farge / overflate	DN	d, ø [mm]
367.616.16.1	2290144	Svart	100	110

Grenrør

Geberit PE grenrør 45°

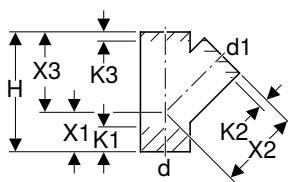

click & scan

Art. nr.	NRF nr.	DN	d, ø [mm]	d1, ø [mm]	arc [°]	H [cm]	X1 [cm]	X2 [cm]	X3 [cm]	K1 maks. [cm]	K2 maks. [cm]	K3 maks. [cm]
379.108.16.1	2291224	30 / 30	32	32	45	10,5	3,5	7	7	2	2	2
360.108.16.1	2291226	40 / 30	40	32	45	13,5	4,5	9	9	3	3,5	3,5
360.109.16.1	2291228	40 / 40	40	40	45	13,5	4,5	9	9	2,5	3	3
361.109.16.1	2291231	50 / 40	50	40	45	16,5	5,5	11	11	4	4,5	4,5
361.112.16.1	2291233	50 / 50	50	50	45	16,5	5,5	11	11	3,5	2	2
363.112.16.1	2291235	56 / 50	56	50	45	18	6	12	12	4	3	3
363.115.16.1	2291237	56 / 56	56	56	45	18	6	12	12	4	2,5	2,5
364.109.16.1	2291239	60 / 40	63	40	45	19,5	6,5	13	13	4,5	4,5	4
364.112.16.1	2291242	60 / 50	63	50	45	19,5	6,5	13	13	5	3	3
364.115.16.1	2290204	60 / 56	63	56	45	19,5	6,5	13	13	4,5	2,5	2,5
364.120.16.1	2291244	60 / 60	63	63	45	19,5	6,5	13	13	4	2	2
365.109.16.1	2291246	70 / 40	75	40	45	21	7	14	14	6,5	5	6
365.112.16.1	2291248	70 / 50	75	50	45	21	7	14	14	6	3	4
365.115.16.1	2290205	70 / 56	75	56	45	21	7	14	14	5,5	2,5	3,5
365.120.16.1	2291251	70 / 60	75	63	45	21	7	14	14	4,5	2,5	3,5
365.125.16.1	2291253	70 / 70	75	75	45	21	7	14	14	4	2,5	2,5
366.109.16.1	2291255	90 / 40	90	40	45	24	8	16	16	7,5	5,5	6,5
366.112.16.1	2291257	90 / 50	90	50	45	24	8	16	16	8	4	5
366.115.16.1	2290206	90 / 56	90	56	45	24	8	16	16	7,5	3,5	4,5
366.120.16.1	2291259	90 / 60	90	63	45	24	8	16	16	7	3	4
366.125.16.1	2291262	90 / 70	90	75	45	24	8	16	16	6,5	3	3,5
366.130.16.1	2291264	90 / 90	90	90	45	24	8	16	16	5	2	2
367.109.16.1	2291266	100 / 40	110	40	45	27	9	18	18	9,5	6	7,5
367.112.16.1	2291268	100 / 50	110	50	45	27	9	18	18	9,5	5	5,5
367.115.16.1	2290207	100 / 56	110	56	45	27	9	18	18	9	4	4,5
367.120.16.1	2291271	100 / 60	110	63	45	27	9	18	18	8,5	3,5	4
367.125.16.1	2291273	100 / 70	110	75	45	27	9	18	18	7,5	3	3,5
367.130.16.1	2291275	100 / 90	110	90	45	27	9	18	18	6,5	2,5	3
367.135.16.1	2291277	100 / 100	110	110	45	27	9	18	18	5,5	2	2
368.120.16.1	2291279	125 / 60	125	63	45	30	10	20	20	10,5	4,5	6
368.125.16.1	2291282	125 / 70	125	75	45	30	10	20	20	9,5	4	5
368.130.16.1	2291284	125 / 90	125	90	45	30	10	20	20	8,5	3	3,5
368.135.16.1	2291286	125 / 100	125	110	45	30	10	20	20	7	2,5	2,5
368.139.16.1	2291288	125 / 125	125	125	45	30	10	20	20	6	2	2
369.125.16.1	2291291	150 / 70	160	75	45	37,5	12,5	25	25	13,5	6,5	7,5
369.130.16.1	2290208	150 / 90	160	90	45	37,5	12,5	25	25	12,5	5,5	6,5
369.135.16.1	2291295	150 / 100	160	110	45	37,5	12,5	25	25	11	4,5	5,5
369.139.16.1	2291297	150 / 125	160	125	45	37,5	12,5	25	25	10	4	5
369.145.16.1	2291299	150 / 150	160	160	45	37,5	12,5	25	25	7,5	2,5	2,5
370.135.16.1	2291302	200 / 100	200	110	45	54	18	36	36	7,5	10	0
370.139.16.1	2291304	200 / 125	200	125	45	54	18	36	36	5,5	9	0
370.145.16.1	2291306	200 / 150	200	160	45	54	18	36	36	4	5,5	0
370.146.16.1	2291308	200 / 200	200	200	45	54	18	36	36	0	0	0
371.135.16.1	2291311	250 / 100	250	110	45	66	22	44	44	14	10	7,5
371.139.16.1	2290209	250 / 125	250	125	45	66	22	44	44	13	13	6,5
371.145.16.1	2291315	250 / 150	250	160	45	66	22	44	44	10,5	10	0
371.146.16.1	2291317	250 / 200	250	200	45	66	22	44	44	7,5	0	1,5
371.147.16.1	2291319	250 / 250	250	250	45	66	22	44	44	4	0	0
372.135.16.1	2291322	300 / 100	315	110	45	84	28	56	56	23	20	16
372.139.16.1	2290211	300 / 125	315	125	45	84	28	56	56	21,5	20	14,5
372.145.16.1	2291326	300 / 150	315	160	45	84	28	56	56	19,5	17,5	12,5
372.146.16.1	2291328	300 / 200	315	200	45	84	28	56	56	16,5	5	10
372.147.16.1	2291331	300 / 250	315	250	45	84	28	56	56	13	5,5	6,5
372.148.16.1	2291333	300 / 300	315	315	45	84	28	56	56	8,5	2	2



Geberit PE bendgren 88,5°

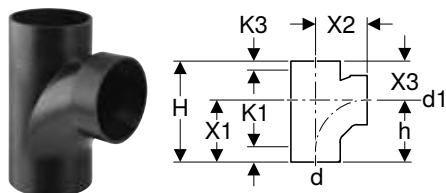

click & scan

Art. nr.	NRF nr.	DN	d, ø [mm]	d1, ø [mm]	arc [°]	H [cm]	h [cm]	X1 [cm]	X2 [cm]	X3 [cm]	K1 maks. [cm]
367.163.16.1	2290156	100 / 100	110	110	88,5	22,5	13,8	13,5	11,5	9	2,5

Geberit PE grenrør 88,5°

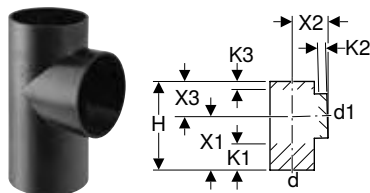

click & scan

Art. nr.	NRF nr.	DN	d, ø [mm]	d1, ø [mm]	arc [°]	H [cm]	X1 [cm]	X2 [cm]	X3 [cm]	K1 maks. [cm]	K2 maks. [cm]	K3 maks. [cm]
379.158.16.1	2291354	30 / 30	32	32	88,5	8,5	5	3,5	3,5	2,5	1	1
360.158.16.1	2291356	40 / 30	40	32	88,5	13	7,5	5,5	5,5	5	2,5	2
360.159.16.1	2291358	40 / 40	40	40	88,5	13	7,5	5,5	5,5	4,5	2,5	2,5
361.159.16.1	2291361	50 / 40	50	40	88,5	15	9	6	6	6	2,5	3
361.162.16.1	2291363	50 / 50	50	50	88,5	15	9	6	6	5,5	2,5	2,5
363.162.16.1	2291365	56 / 50	56	50	88,5	17,5	10,5	7	7	7	3	3,5
363.165.16.1	2291367	56 / 56	56	56	88,5	17,5	10,5	7	7	6,5	3	3
364.162.16.1	2291372	60 / 50	63	50	88,5	17,5	10,5	7	7	7	3	3,5
364.165.16.1	2290212	60 / 56	63	56	88,5	17,5	10,5	7	7	6,5	3	3
364.170.16.1	2291374	60 / 60	63	63	88,5	17,5	10,5	7	7	6	3	3
365.159.16.1	2291376	70 / 40	75	40	88,5	17,5	10,5	7	7	7,5	2,5	4
365.162.16.1	2291378	70 / 50	75	50	88,5	17,5	10,5	7	7	7	2,5	3,5
365.165.16.1	2290213	70 / 56	75	56	88,5	17,5	10,5	7	7	6,5	2,5	3
365.170.16.1	2291381	70 / 60	75	63	88,5	17,5	10,5	7	7	6	2,5	2,5
365.175.16.1	2291383	70 / 70	75	75	88,5	17,5	10,5	7	7	5,5	2,5	2,5
366.159.16.1	2291385	90 / 40	90	40	88,5	20	12	8	8	8,5	2,5	4,5
366.162.16.1	2291387	90 / 50	90	50	88,5	20	12	8	8	8,5	2,5	4,5
366.165.16.1	2290214	90 / 56	90	56	88,5	20	12	8	8	8	2,5	4
366.170.16.1	2291389	90 / 60	90	63	88,5	20	12	8	8	7,5	2,5	3,5
366.175.16.1	2291392	90 / 70	90	75	88,5	20	12	8	8	7	2,5	3
366.180.16.1	2291394	90 / 90	90	90	88,5	20	12	8	8	6,5	2,5	2,5
367.159.16.1	2291396	100 / 40	110	40	88,5	22,5	13,5	9	9	10	2,5	6
367.162.16.1	2291398	100 / 50	110	50	88,5	22,5	13,5	9	9	9,5	2,5	5
367.165.16.1	2290215	100 / 56	110	56	88,5	22,5	13,5	9	9	9	2,5	4,5
367.170.16.1	2291402	100 / 60	110	63	88,5	22,5	13,5	9	9	9	2,5	4
367.175.16.1	2291404	100 / 70	110	75	88,5	22,5	13,5	9	9	8,5	2,5	3,5
367.180.16.1	2291406	100 / 90	110	90	88,5	22,5	13,5	9	9	7,5	2,5	3
367.185.16.1	2291408	100 / 100	110	110	88,5	22,5	13,5	9	9	6,5	2	2
368.162.16.1	2290216	125 / 50	125	50	88,5	25	15	10	10	11	2,5	6
368.165.16.1	2290217	125 / 56	125	56	88,5	25	15	10	10	10,5	2,5	5,5
368.170.16.1	2291413	125 / 60	125	63	88,5	25	15	10	10	10,5	2,5	5
368.175.16.1	2291415	125 / 70	125	75	88,5	25	15	10	10	10	2,5	4,5
368.180.16.1	2291417	125 / 90	125	90	88,5	25	15	10	10	9	2,5	4
368.185.16.1	2291419	125 / 100	125	110	88,5	25	15	10	10	8	2	3
368.189.16.1	2291422	125 / 125	125	125	88,5	25	15	10	10	7	2	2
369.175.16.1	2290218	150 / 70	160	75	88,5	35	21	14	14	15	4,5	8
369.185.16.1	2291424	150 / 100	160	110	88,5	35	21	14	14	13,5	4,5	6
369.189.16.1	2290219	150 / 125	160	125	88,5	35	21	14	14	12,5	4,5	5
369.195.16.1	2291428	150 / 150	160	160	88,5	35	21	14	14	10,5	3,5	3
370.185.16.1	2290221	200 / 100	200	110	88,5	36	18	18	18	0	3	0
370.189.16.1	2290222	200 / 125	200	125	88,5	36	18	18	18	0	3	0
370.195.16.1	2291433	200 / 150	200	160	88,5	36	18	18	18	0	2	0
370.196.16.1	2291435	200 / 200	200	200	88,5	40	20	20	20	0	0	0
371.185.16.1	2290223	250 / 100	250	110	88,5	44	22	22	22	3,5	4	3,5
371.189.16.1	2290224	250 / 125	250	125	88,5	44	22	22	22	3	4	3

Art. nr.	NRF nr.	DN	d, ø [mm]	d1, ø [mm]	arc [°]	H [cm]	X1 [cm]	X2 [cm]	X3 [cm]	K1 maks. [cm]	K2 maks. [cm]	K3 maks. [cm]
371.195.16.1	2291442	250 / 150	250	160	88,5	44	22	22	22	0	3,5	0
371.196.16.1	2291444	250 / 200	250	200	88,5	48	24	24	24	0	0	0
372.185.16.1	2290225	300 / 100	315	110	88,5	56	28	28	28	9,5	6	9,5
372.189.16.1	2290226	300 / 125	315	125	88,5	56	28	28	28	9	6	9
372.195.16.1	2291453	300 / 150	315	160	88,5	56	28	28	28	7	6	7
372.196.16.1	2291455	300 / 200	315	200	88,5	56	28	28	28	4,5	0	4,5
372.197.16.1	2291457	300 / 250	315	250	88,5	56	28	28	28	2	0	2
372.198.16.1	2291459	300 / 300	315	315	88,5	56	28	28	28	0	0	0

Geberit PE buksegren 45° dobbelt

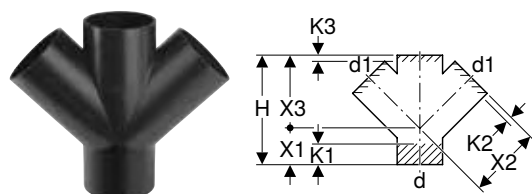

click & scan

Art. nr.	NRF nr.	DN	d, ø [mm]	d1, ø [mm]	H [cm]	X1 [cm]	X2 [cm]	X3 [cm]	K1 maks. [cm]	K2 maks. [cm]	K3 maks. [cm]
367.235.16.1	2290161	100 / 100	110	110	27	9	18	18	5	1,5	1,5

Geberit PE kulegren 88,5° dobbel, tilkoplinger 90° forskjøvet

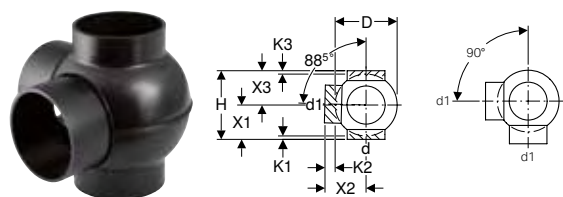

click & scan

Art. nr.	NRF nr.	DN	d, ø [mm]	d1, ø [mm]	arc2 [°]	D [cm]	H [cm]	X1 [cm]	X2 [cm]	X3 [cm]	K1 maks. [cm]	K2 maks. [cm]	K3 maks. [cm]
365.325.16.1	2290235	70 / 70	75	75	90	12	16	8	10	8	1,5	3,5	1,5
366.330.16.1	2290238	90 / 90	90	90	90	14	18	9	11	9	2	4	2
367.315.16.1	2290245	100 / 56	110	56	90	17	20	10	12	10	1,5	1,5	1,5
367.320.16.1	2290246	100 / 60	110	63	90	17	20	10	12	10	1,5	1,5	1,5
367.325.16.1	2290247	100 / 70	110	75	90	17	20	10	12	10	1,5	1,5	1,5
367.330.16.1	2290248	100 / 90	110	90	90	17	20	10	12	10	1,5	1,5	1,5
367.335.16.1	2291652	100 / 100	110	110	90	17	20	10	12	10	1,5	4	1,5

Geberit PE kulegren 88,5° dobbel, tilkoplinger 135° forskjøvet

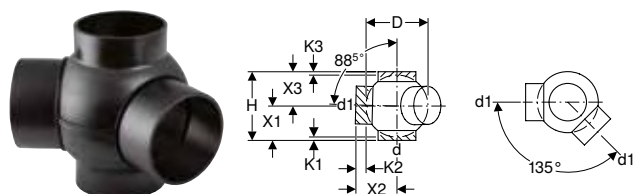

click & scan

Art. nr.	NRF nr.	DN	d, ø [mm]	d1, ø [mm]	arc2 [°]	D [cm]	H [cm]	X1 [cm]	X2 [cm]	X3 [cm]	K1 maks. [cm]	K2 maks. [cm]	K3 maks. [cm]
365.375.16.1	2290236	70 / 70	75	75	135	12	16	8	10	8	1,5	3,5	1,5
367.362.16.1	2290249	100 / 40	110	50	135	17	20	10	12	10	1,5	1,5	1,5
367.365.16.1	2290251	100 / 56	110	56	135	17	20	10	12	10	1,5	1,5	1,5
367.370.16.1	2290252	100 / 60	110	63	135	17	20	10	12	10	1,5	1,5	1,5
367.375.16.1	2291697	100 / 70	110	75	135	17	20	10	12	10	1,5	1,5	1,5
367.380.16.1	2290253	100 / 90	110	90	135	17	20	10	12	10	1,5	1,5	1,5
367.385.16.1	2291711	100 / 100	110	110	135	17	20	10	12	10	1,5	4	1,5

Geberit PE kulegren 88,5° dobbel, tilkoblinger 180° forskjøvet

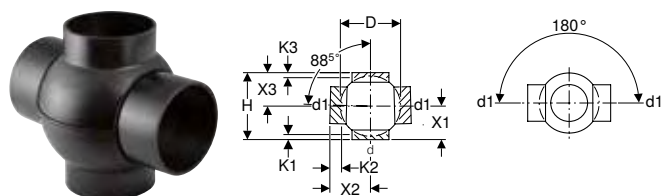

click & scan

Art. nr.	NRF nr.	DN	d, ø [mm]	d1, ø [mm]	arc2 [°]	D [cm]	H [cm]	X1 [cm]	X2 [cm]	X3	K1 maks. [cm]	K2 maks. [cm]	K3 maks. [cm]
364.270.16.1	2290233	60 / 60	63	63	180	10	16	8	10	8	1,5	4,5	1,5
365.275.16.1	2290234	70 / 70	75	75	180	12	16	8	10	8	1,5	3,5	1,5
366.280.16.1	2290237	90 / 90	90	90	180	14	18	9	11	9	2	4	2
367.262.16.1	2290239	100 / 40	110	50	180	17	20	10	12	10	1,5	1,5	1,5
367.265.16.1	2290241	100 / 56	110	56	180	17	20	10	12	10	1,5	1,5	1,5
367.270.16.1	2290242	100 / 60	110	63	180	17	20	10	12	10	1,5	1,5	1,5
367.275.16.1	2290243	100 / 70	110	75	180	17	20	10	12	10	1,5	1,5	1,5
367.280.16.1	2290244	100 / 90	110	90	180	17	20	10	12	10	1,5	1,5	1,5
367.285.16.1	2291602	100 / 100	110	110	180	17	20	10	12	10	1,5	4	1,5
368.285.16.1	2290254	125 / 100	125	110	180	18	20	10	12,5	10	1,5	4	1,5

Geberit PE kulegren 88,5° tredobbel, tilkoblinger 90° forskjøvet

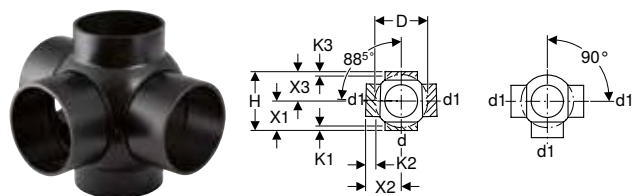

click & scan

Art. nr.	NRF nr.	DN	d, ø [mm]	d1, ø [mm]	arc [°]	arc2 [°]	D [cm]	H [cm]	X1 [cm]	X2 [cm]	X3 [cm]	K1 maks. [cm]	K2 maks. [cm]	K3 maks. [cm]
365.605.16.1	2290255	70 / 70	75	75	88,5	90	12	16	8	10	8	1,5	3,5	1,5
366.605.16.1	2290256	80 / 80	90	90	88,5	90	14	18	9	11	9	2	4	2
367.605.16.1	2291781	100 / 100	110	110	88,5	90	17	20	10	12	10	1,5	4	1,5
368.605.16.1	2290257	125 / 100	125	110	88,5	90	18	20	10	12	10	1,5	4	1,5

Geberit PE kulegren 88,5° tredobbel, tilkoblinger 135° forskjøvet

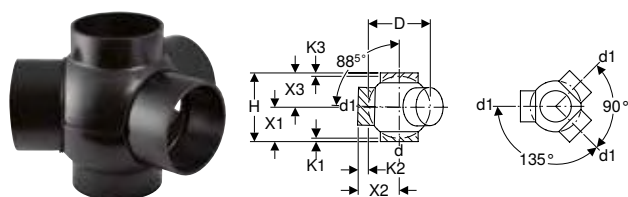

click & scan

Art. nr.	NRF nr.	DN	d, ø [mm]	d1, ø [mm]	arc [°]	arc2 [°]	D [cm]	H [cm]	X1 [cm]	X2 [cm]	X3 [cm]	K1 maks. [cm]	K2 maks. [cm]	K3 maks. [cm]
367.600.16.1	2291742	100 / 100	110	110	88,5	135	17	20	10	12	10	1,5	4	1,5

Geberit PE kulegren 88,5° firedobbel, tilkoblinger 90° forskjøvet

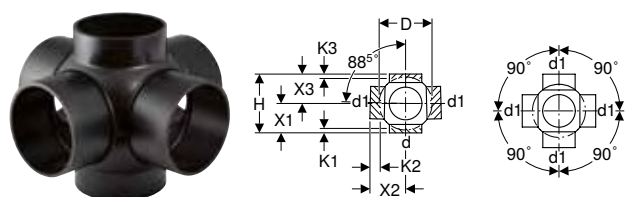

click & scan

Art. nr.	NRF nr.	DN	d, ø [mm]	d1, ø [mm]	arc [°]	arc2 [°]	D [cm]	H [cm]	X1 [cm]	X2 [cm]	X3 [cm]	K1 maks. [cm]	K2 maks. [cm]	K3 maks. [cm]
367.610.16.1	2291822	100 / 100	110	110	88,5	90	17	20	10	12	10	1,5	4	1,5

Geberit PE buksegren 2 x 30°

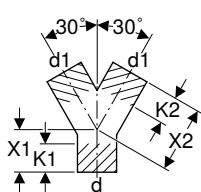

click & scan

Art. nr.	NRF nr.	DN	d, ø [mm]	d1, ø [mm]	arc [°]	X1 [cm]	X2 [cm]	K1 maks. [cm]	K2 maks. [cm]
361.459.16.1	2290162	50 / 40	50	40	30	5,5	11	4	5
361.462.16.1	2290163	50 / 50	50	50	30	5,5	11	3	4
363.462.16.1	2290164	56 / 50	56	50	30	6	12	4	5
363.465.16.1	2290165	56 / 56	56	56	30	1,8	5,3	0	0
364.462.16.1	2290166	60 / 50	63	50	30	6,5	13	5	6
365.465.16.1	2290167	70 / 56	75	56	30	7	14	6	7
365.470.16.1	2290168	70 / 60	75	63	30	7	14	5	6
367.480.16.1	2290169	100 / 90	110	90	30	9	18	7	7
367.481.16.1	2290171	100 / 100	110	110	30	9	10,2	5	0

Reduksjoner

Geberit PE eksentriske reduksjon, kort

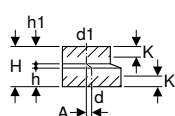

click & scan

Art. nr.	NRF nr.	DN	d, ø [mm]	d1, ø [mm]	A [cm]	H [cm]	h [cm]	h1 [cm]	K [cm]
361.558.16.1	2292111	50 / 40	50	40	0,5	8	3,5	3,7	2
363.558.16.1	2292113	56 / 40	56	40	0,8	8	3,5	3,7	2
363.561.16.1	2292115	56 / 50	56	50	0,3	8	3,5	3,7	2
364.558.16.1	2292117	60 / 40	63	40	1,2	8	3,5	3,7	2
364.561.16.1	2292119	60 / 50	63	50	0,7	8	3,5	3,7	2
364.566.16.1	2292122	60 / 56	63	56	0,4	8	3,5	3,7	2
365.558.16.1	2292124	70 / 40	75	40	1,8	8	3,5	3,7	2
365.561.16.1	2292126	70 / 50	75	50	1,3	8	3,5	3,7	2
365.566.16.1	2292128	70 / 56	75	56	1	8	3,5	3,7	2
365.571.16.1	2292131	70 / 60	75	63	0,6	8	3,5	3,7	2
366.561.16.1	2292135	90 / 50	90	50	2	8	3,5	3,7	2
366.566.16.1	2292137	90 / 56	90	56	1,7	8	3,5	3,7	2
366.571.16.1	2292139	90 / 60	90	63	1,3	8	3,5	3,7	2
366.576.16.1	2290178	90 / 70	90	75	0,8	8	3,5	3,7	2
367.558.16.1	2290179	100 / 40	110	40	3,4	8	3,5	3,7	2
367.561.16.1	2292146	100 / 50	110	50	2,9	8	3,5	3,7	2
367.566.16.1	2292148	100 / 56	110	56	2,6	8	3,5	3,7	2
367.571.16.1	2292151	100 / 60	110	63	2,2	8	3,5	3,7	2
367.576.16.1	2292153	100 / 70	110	75	1,6	8	3,5	3,7	2
367.581.16.1	2292155	100 / 90	110	90	0,9	8	3,5	3,7	2
368.561.16.1	2292157	125 / 50	125	50	3,6	8	3,5	3,7	2
368.566.16.1	2292159	125 / 56	125	56	3,3	8	3,5	3,7	2
368.571.16.1	2292162	125 / 60	125	63	2,9	8	3,5	3,7	2
368.576.16.1	2292164	125 / 70	125	75	2,3	8	3,5	3,7	2
368.581.16.1	2292166	125 / 90	125	90	1,6	8	3,5	3,7	2
368.586.16.1	2292168	125 / 100	125	110	0,7	8	3,5	3,7	2
369.586.16.1	2292171	150 / 100	160	110	2,3	8	3,5	3,7	2
369.588.16.1	2292173	150 / 125	160	125	1,6	8	3,5	3,7	2
369.591.16.1	2290184	150 / 140	160	140	1	8	3,5	3,7	2

Geberit PE eksentrisk reduksjon, lang

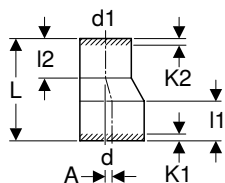

click & scan

Art. nr.	NRF nr.	DN	d, ø [mm]	d1, ø [mm]	A [cm]	L [cm]	l1 [cm]	l2 [cm]	K1 maks. [cm]	K2 maks. [cm]
368.584.16.1	2290181	125 / 100	125	110	0,7	16	7	6,4	4	3
369.584.16.1	2290182	150 / 100	160	110	2,5	28	9,4	6,4	6	3
369.587.16.1	2290183	150 / 125	160	125	1,7	24	9,4	8	6	5
370.584.16.5	2292225	200 / 100	200	110	4,3	28	11,5	3,7	4	0
370.587.16.5	2292227	200 / 125	200	125	3,6	28	11,5	3,7	4	0
370.594.16.5	2292229	200 / 150	200	160	2	28	11,9	9,1	4	6
371.596.16.1	2292232	250 / 200	250	200	2,5	40,5	15,8	15,7	8	8
372.596.16.1	2290185	300 / 200	315	200	5,7	58	16,1	15,7	8	8
372.598.16.1	2292236	300 / 250	315	250	3,2	43,5	16,1	15,7	8	8

Geberit PE sentrisk reduksjon, kort

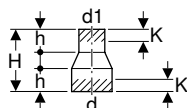

click & scan

Art. nr.	NRF nr.	DN	d, ø [mm]	d1, ø [mm]	H [cm]	h [cm]	K [cm]
360.557.16.1	2292006	40 / 30	40	32	8	3	1,5
361.557.16.1	2292008	50 / 30	50	32	8	3	1,5
361.559.16.1	2292011	50 / 40	50	40	8	3	1,5
363.559.16.1	2292013	56 / 40	56	40	8	3	1,5
363.560.16.1	2292015	56 / 50	56	50	8	3	1,5
364.559.16.1	2292017	60 / 40	63	40	8	3	1,5
364.560.16.1	2292019	60 / 50	63	50	8	3	1,5
364.565.16.1	2292022	60 / 56	63	56	8	3	1,5
365.559.16.1	2292024	70 / 40	75	40	8	3	1,5
365.560.16.1	2292026	70 / 50	75	50	8	3	1,5
365.565.16.1	2292028	70 / 56	75	56	8	3	1,5
365.570.16.1	2292031	70 / 60	75	63	8	3	1,5
366.559.16.1	2292033	90 / 40	90	40	8	3	1,5
366.560.16.1	2292035	90 / 50	90	50	8	3	1,5
366.565.16.1	2292037	90 / 56	90	56	8	3	1,5
366.570.16.1	2292039	90 / 60	90	63	8	3	1,5
366.575.16.1	2292042	90 / 70	90	75	8	3	1,5
367.559.16.1	2292044	100 / 40	110	40	8	3	1,5
367.560.16.1	2292046	100 / 50	110	50	8	3	1,5
367.565.16.1	2292048	100 / 56	110	56	8	3	1,5
367.570.16.1	2292051	100 / 60	110	63	8	3	1,5
367.575.16.1	2292053	100 / 70	110	75	8	3	1,5
367.580.16.1	2292055	100 / 90	110	90	8	3	1,5
368.575.16.1	2292064	125 / 70	125	75	8	3	1,5
368.580.16.1	2290332	125 / 90	125	90	8	3	1,5
368.585.16.1	2292068	125 / 100	125	110	8	3	1,5
369.535.16.1	2292071	150 / 100	160	110	4	0,6	0

Stakeluger

Geberit PE stakeluke 90° med rund serviceåpning

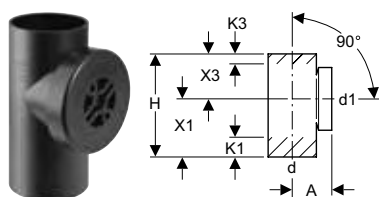

click & scan

Art. nr.	NRF nr.	DN	d, ø [mm]	d1, ø [mm]	arc [°]	A [cm]	H [cm]	X1 [cm]	X3 [cm]	K1 maks. [cm]	K3 maks. [cm]
364.451.16.1	2291884	60 / 60	63	63	90	9	17,5	10,5	7	4,5	0
365.451.16.1	2291886	70 / 70	75	75	90	9,5	17,5	10,5	7	3,5	0
366.451.16.1	2291888	90 / 90	90	90	90	11	20	12	8	3	0
367.451.16.1	2291891	100 / 100	110	110	90	9	24	13,5	10,5	4,5	0
368.451.16.1	2291893	125 / 100	125	110	90	13	25	15	10	6	1
369.451.16.1	2291895	150 / 100	160	110	90	15	35	21	14	12	4

Geberit PE stakeluke 90° med oval serviceåpning

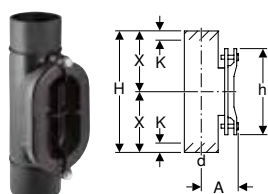

click & scan

Art. nr.	NRF nr.	DN	d, ø [mm]	arc [°]	A [cm]	H [cm]	h [cm]	X [cm]	K [cm]
367.454.16.1	2291974	100	110	90	12	40	28	20	3
368.454.16.1	2291976	125	125	90	12,5	41	28	20,5	4
369.454.16.1	2291978	150	160	90	14	43	28	21,5	4
370.454.16.1	2291981	200	200	90	17,5	65	38	32,5	5,5
371.454.16.1	2291983	250	250	90	20	58	38	29	3
372.454.16.1	2291985	300	315	90	23	62	38	31	8

Overganger

Geberit PE reduksjonsmuffe



click & scan

Art. nr.	NRF nr.	DN	d1, ø [mm]	d2, ø [mm]
367.928.16.1	6167053	90 / 100	90	110

Spesialformstykker

Geberit PE Sovent formstykke

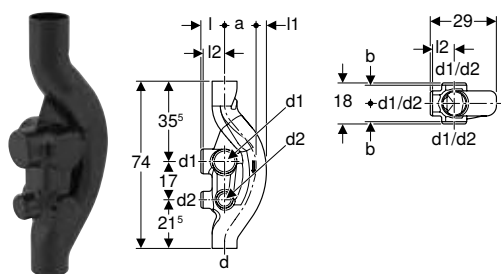

click & scan

Art. nr.	NRF nr.	DN	d, ø [mm]	d1, ø [mm]	d2, ø [mm]	a [cm]	l [cm]	l1 [cm]	l2 [cm]	b [cm]
367.614.16.1	2290341	100 / 100 / 70	110	110	75	13	10,5	5,5	9,5	8

Forbindelser

Sveiseforbindelser

Geberit elektro-sveisemuffe



click & scan

Art. nr.	NRF nr.	DN	d, ø [mm]	D [cm]	E [cm]	H [cm]	X [cm]
360.771.16.1	2292466	40	40	5,2	2,8	6	0,3
361.771.16.1	2292468	50	50	6,2	2,8	6	0,3
363.771.16.1	2292471	56	56	6,8	2,8	6	0,3
364.771.16.1	2292473	60	63	7,6	2,8	6	0,3
365.771.16.1	2292475	70	75	8,9	2,8	6	0,3
366.771.16.1	2292477	90	90	10,4	2,8	6	0,3
367.771.16.1	2292479	100	110	12,5	2,8	6	0,3
368.771.16.1	2292482	125	125	14,2	2,8	6	0,3
369.771.16.1	2292484	150	160	17,8	2,8	6	0,3

Geberit PE el-muffe med integrert termosikring

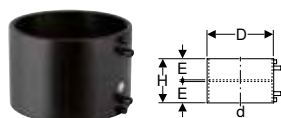

click & scan

Art. nr.	NRF nr.	DN	d, ø [mm]	D [cm]	E [cm]	H [cm]
370.775.16.1	2292514	200	200	22,4	7,5	15
371.775.16.1	2292516	250	250	27,5	7,5	15
372.775.16.1	2292518	300	315	34,3	7,5	15

Ekspansjonsmuffer

Geberit PE ekspansjonsmuffe med dobbeltbryst

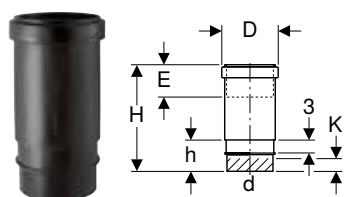

click & scan

Art. nr.	NRF nr.	DN	d, ø [mm]	D [cm]	E [cm]	I [cm]	H [cm]	h [cm]	K [cm]
379.791.16.1	2292334	30	32	4,6	3,5-7	3	12,8	3,9	0
360.700.16.1	2292336	40	40	5,5	6,5-13	3	23,7	6,8	3
361.700.16.1	2292338	50	50	6,7	6,5-13	3	24	6,8	3
363.700.16.1	2292341	56	56	7,4	6,5-13	3	24	6,8	3
364.700.16.1	2292343	60	63	8,3	7-13,5	3	24,3	6,8	3
365.700.16.1	2292345	70	75	9,7	7-13,5	3	24,6	6,8	3
366.700.16.1	2292347	90	90	11,3	7-13,5	3	24,9	6,9	3
367.700.16.1	2292349	100	110	13,6	7,5-14	3	25,6	7,3	3,5
368.700.16.1	2292352	125	125	15,7	8-14,5	3	26,1	7,4	3,5
369.700.16.1	2292354	150	160	19,5	8-14,5	3	26,8	7,4	3,5

Geberit PE ekspansjonsmuffe

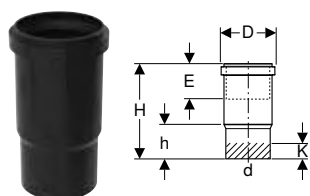

click & scan

Art. nr.	NRF nr.	DN	d, ø [mm]	D [cm]	E [cm]	H [cm]	h [cm]	K [cm]
370.700.16.1	2292356	200	200	24,3	17-23,5	43	15,6	13
371.700.16.1	2292358	250	250	29,1	17-23,5	42,5	17	14
372.700.16.1	2292361	300	315	36,1	17-23,5	45,8	17,5	14

Geberit PE ekspansjonsmuffe med pakningsbeskyttelse

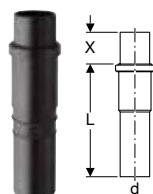

click & scan

Art. nr.	NRF nr.	DN	d, ø [mm]	L [cm]	X [cm]
367.701.16.1	2290186	100	110	42	5-15,5
368.701.16.1	2290187	125	125	42	5-15,5
369.701.16.1	2290188	150	160	42	5-15,5
370.701.16.1	2290189	200	200	64	9,5-21,5
371.701.16.1	2290191	250	250	64	9,5-21,5
372.701.16.1	2290192	300	315	64	9,5-21,5

Geberit PE stikkuffe med leppepakning

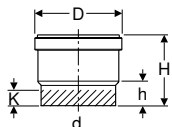

click & scan

Art. nr.	NRF nr.	DN	d, ø [mm]	D [cm]	H [cm]	h [cm]	K [cm]
360.779.16.3	2290011	40	40	5,5	8	3,5	2,5
361.779.16.3	2290012	50	50	6,5	8	3,5	2,5
363.779.16.3	2290013	56	56	7	8,3	3,5	2,5
364.779.16.3	2290014	60	63	7,8	8,8	3,5	2,5
365.779.16.3	2290015	70	75	9	9,7	3,5	2,5
366.779.16.3	2290016	90	90	10,6	10,3	3,6	2
367.779.16.3	2290017	100	110	12,9	10,5	3,7	2
368.779.16.3	2290018	125	125	14,7	11	3,8	2
369.779.16.3	2290019	150	160	18,5	13,6	4	2

Overganger til andre materialer

Geberit kromstålkobling

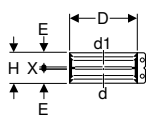

click & scan

Art. nr.	NRF nr.	DN	d, ø [mm]	d1, ø [mm]	D [cm]	E [cm]	H [cm]	X [cm]
359.424.00.2	2293921	50	48-50	48-50	6,3	2,7	5,7	0,3
359.465.00.2	2293909	50	50	58	7,5	2,7	5,7	0,3
359.425.00.2	2293922	50	54-56	54-56	7,5	2,7	5,7	0,3
359.426.00.2	2293923	56	56	58	7,5	2,7	5,7	0,3
359.427.00.2	2293924	56	56	68	8,3	2,7	5,7	0,3
359.428.00.2	2293925	60	63	60	7,8	2,7	5,7	0,3
359.429.00.2	2293926	60	63-64	63-64	7,8	2,7	5,7	0,3
359.430.00.2	2293927	60	63-64	68	8,3	2,7	5,7	0,3
359.431.00.2	2293928	70	68	68	8,3	2,6	5,6	0,4
359.432.00.2	2293903	70	75	68	9	2,7	5,7	0,3
359.433.00.2	2293929	70	75-76	75-76	8,8	2,7	5,7	0,3
359.434.00.2	2293931	70	75-76	78	9,3	2,7	5,7	0,3
359.435.00.2	2293932	70	75-76	83-84	9,8	2,7	5,7	0,3
359.436.00.2	2293904	70	75-76	89-90	10,3	2,7	5,7	0,3
359.437.00.2	2293933	90	89-90	83-84	11,1	2,7	5,7	0,3
359.438.00.2	2293905	90	89-90	89-90	10,3	2,7	5,7	0,3
359.439.00.2	2293934	90	89-90	96	11,1	3,3	6,9	0,3
359.440.00.2	2293935	100	108-110	106	12,5	2,7	5,7	0,3
359.441.00.2	2293906	100	108-110	108-110	12,5	2,7	5,7	0,3
359.442.00.2	2293936	100	108-110	114-116	13,1	3,3	6,9	0,3
359.443.00.2	2293937	125	125	125	14	2,7	5,7	0,3
359.444.00.2	2293907	125	125	131-135	15	3,3	6,9	0,3
359.445.00.2	2293938	125	125	140-141	15,6	3,3	6,9	0,3
359.447.00.2	2293941	125	140-141	140-141	15,5	3,3	6,9	0,3
359.448.00.2	2293942	150	159-160	152	17,5	3,3	6,9	0,3
359.449.00.2	2293908	150	159-160	159-160	17,5	3,3	6,9	0,3
359.450.00.2	2293943	150	159-160	168	18,3	3,3	6,9	0,3
359.451.00.2	2293944	200	210	210	22,5	3,3	6,9	0,3

Geberit PE støttering

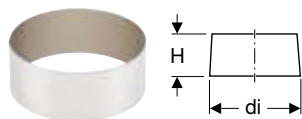

click & scan

Art. nr.	NRF nr.	DN	d, ø [mm]	di, ø [mm]	H [cm]
359.454.00.1	2290344	50	50	44	4
359.455.00.1	2290345	56	56	50	4
359.456.00.1	2290346	60	63	57	4
359.457.00.1	2290347	70	75	69	4
359.458.00.1	2290348	90	90	83	4
359.459.00.1	2290349	100	110	101,4	4
359.462.00.1	2290351	125	125	115,2	4
359.463.00.1	2290352	125	140	129,2	4
359.464.00.1	2290353	150	160	147,6	4

Geberit PE overgangsmansjett på støpejern, med støttering

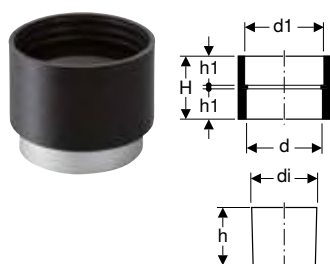

click & scan

Art. nr.	NRF nr.	DN	d, ø [mm]	d1, ø [mm]	di, ø [mm]	H [cm]	h [cm]	h1 [cm]
359.140.00.1	2290275	50	50	58	46	4,4	4	2,1
359.141.00.1	2290276	70	75	78	70	4,8	4	2,2
359.142.00.1	2290277	125	125	135	117	5,8	4	2,7

Geberit PE overgangsstykke på støpejern

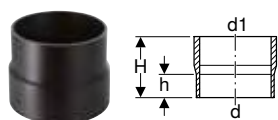

click & scan

Art. nr.	NRF nr.	DN	d, ø [mm]	d1, ø [mm]	H [cm]	h [cm]
370.738.16.1	2290306	200	200	212	16	8
371.738.16.1	2290307	250	250	274	16	11,5
372.738.16.1	2290308	300	315	326	16	11,5

Geberit PE overgangsstykke på PVC

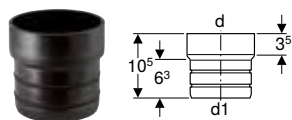

click & scan

Art. nr.	NRF nr.	DN	d, ø [mm]	d1, ø [mm]
359.461.16.1	2290305	100	110	90

Geberit PE overgangsstykke

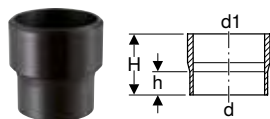

click & scan

Art. nr.	NRF nr.	DN	d, ø [mm]	d1, ø [mm]	H [cm]	h [cm]
359.226.16.1	2290283	100 / 100	110	132	13	5
359.229.16.1	2290284	150 / 150	160	187	14	5

Geberit PE overgangsstykke med krimpemuffe

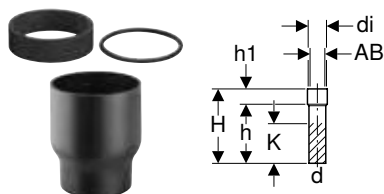

click & scan

Art. nr.	NRF nr.	DN	d, ø [mm]	AB1 [mm]	AB2 [mm]	di, ø [mm]	H [cm]	h [cm]	h1 [cm]	K [cm]
152.153.16.1	2292258	40	40	41-45	35-39	50	24,1	18,8	5,2	13
152.155.16.1	2292263	40	40	60-67	53-60	70	24,9	20,6	4,3	13
152.197.16.1	2292274	50	50	60-67	53-60	70	27,2	22,9	4,3	18
152.198.16.1	2290282	50	50	67-74	60-67	80	28,8	23,6	5,2	18
366.550.16.1	2292298	90	90	84-98		110	17	7,6	9,4	1
367.550.16.1	2292303	100	110	102-126	100-124	140	18	7,5	10,5	1
367.551.16.1	2290297	100	110	102-111	100-109	125	16,2	6,7	9,5	1
368.550.16.1	2290298	125	125	116-136	115-134	150	18	8	10	1
369.550.16.1	2290299	150	160	148-180	149-176	195	20	8,3	11,7	1
369.551.16.1	2290301	150	160	189-212	187-220	230	32,3	16,3	16	3
370.550.16.1	2290302	200	200	189-212	187-220	230	30,2	13,7	16,5	1
371.550.16.1	2290303	250	250	236-260	234-250	280	30,2	13,2	17	1
372.550.16.1	2290304	300	315	297-333	295-323	355	30,2	15,5	14,7	2



- Avhengig av tilkoplingsområdet må enten klemmepakningen eller leppetettingen brukes

Gjengeforbindelser

Geberit PE montasjeflens



click & scan

Art. nr.	NRF nr.	DN	d, ø [mm]	G1 ["]	Rg ["]	H [cm]
361.784.16.1	2290261	50	50	62	1/6"	5
365.784.16.1	2290262	70	75	95	1/6"	7,5
366.784.16.1	2290263	90	90	110	1/4"	7,5
367.784.16.1	2290264	100	110	130	1/4"	7,5

Geberit PE montasjeflens med skrukobling

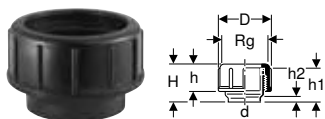

click & scan

Art. nr.	NRF nr.	DN	d, ø [mm]	GI ["]	Rg ["]	D [cm]	H [cm]	h [cm]	h2 [cm]	h1 [cm]
379.740.16.1	2292604	30	32	44	1/8"	5,6	4,5	2,6	1	3
360.740.16.1	2292606	40	40	52	1/6"	6,4	6,3	3,3	2	5
361.740.16.1	2292608	50	50	62	1/6"	7,4	6,3	3,3	2	5
363.740.16.1	2292611	56	56	70	1/6"	8,5	6,8	3,5	2	5
364.740.16.1	2292613	60	63	75	1/6"	9	6,8	4,2	2	5
365.740.16.1	2292615	70	75	95	1/6"	11,2	9,6	4,5	2,5	7,5
366.740.16.1	2292617	90	90	110	1/4"	12,9	9,7	5	2,5	7,5
367.740.16.1	2292619	100	110	130	1/4"	14,9	9,7	6,5	2,5	7,5

Geberit PE montasjeflens med skrulokk

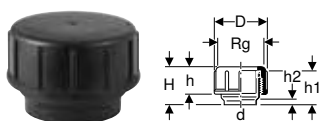

click & scan

Art. nr.	NRF nr.	DN	d, ø [mm]	GI ["]	Rg ["]	D [cm]	H [cm]	h [cm]	h2 [cm]	h1 [cm]
379.750.16.1	2292634	30	32	44	1/8"	5,6	4,5	2,6	1	3
360.750.16.1	2292636	40	40	52	1/6"	6,4	6,3	3,3	2	5
361.750.16.1	2292638	50	50	62	1/6"	7,4	6,3	3,3	2	5
363.750.16.1	2292641	56	56	70	1/6"	8,5	6,8	3,5	2	5
364.750.16.1	2292643	60	63	75	1/6"	9	6,8	4,2	2	5
365.750.16.1	2292645	70	75	95	1/6"	11,2	9,6	4,5	2,5	7,5
366.750.16.1	2292647	90	90	110	1/4"	12,9	9,7	4,8	2,5	7,5
367.750.16.1	2292649	100	110	130	1/4"	14,9	9,7	6,3	2,5	7,5

Geberit PE unionmutter



click & scan

Art. nr.	NRF nr.	DN	d, ø [mm]
379.780.16.1	2290366	30	32
360.780.16.1	2290359	40	40
363.780.16.1	2290361	56	56
364.780.16.1	2290362	60	63
365.780.16.1	2290363	70	75
366.780.16.1	2290364	90	90
367.780.16.1	2290365	100	110

Geberit PE montasjeflens med skrulokk



click & scan

Art. nr.	NRF nr.	DN	d, ø [mm]	GI ["]	Rg ["]	D [cm]	H [cm]
367.471.16.1	2290265	100	110	130	1/4"	14,3	4

Geberit PE overgangsstykke med utvendige gjenger

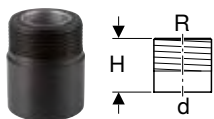

click & scan

Art. nr.	NRF nr.	DN	d, ø [mm]	R ["]	H [cm]
361.726.16.1	2290293	50	50	1 1/4"	6
361.727.16.1	2292915	50	50	1 1/2"	6
363.728.16.1	2292917	56	56	2"	6,5
364.728.16.1	2290294	60	63	2"	6,5
365.729.16.1	2290296	70	75	2 1/2"	7

Geberit PE overgangsstykke med innvendige gjenger

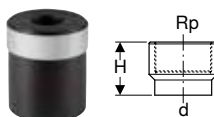

click & scan

Art. nr.	NRF nr.	DN	d, ø [mm]	Rp ["]	H [cm]
360.719.16.1	2290288	40	40	1/2"	5,5
360.720.16.1	2290289	40	40	3/4"	5,5
360.721.16.1	2292861	40	40	1"	5,5
361.719.16.1	2292863	50	50	1/2"	6
361.720.16.1	2292865	50	50	3/4"	6
361.721.16.1	2290291	50	50	1"	6
361.722.16.1	2290292	50	50	1 1/4"	6
361.723.16.1	2292872	50	50	1 1/2"	6
363.724.16.1	2292876	56	56	2"	6,5
364.724.16.1	2292878	60	63	2"	7
365.725.16.1	2290295	70	75	2 1/2"	7

Geberit PE overgangsstykke med utvendige gjenger og skrukobling

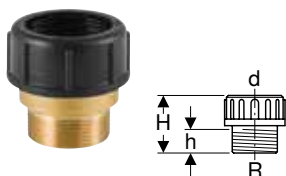

click & scan

Art. nr.	NRF nr.	DN	d, ø [mm]	R ["]	H [cm]	h [cm]
359.309.00.1	2290285	50	50	1 1/2"	6,5	2,7
359.311.00.1	2290286	56	56	2"	6,5	2,7

Geberit PE overgangsstykke med innvendige gjenger og skrukobling

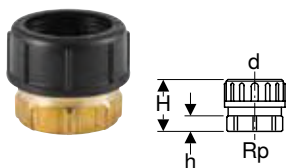

click & scan

Art. nr.	NRF nr.	DN	d, ø [mm]	Rp ["]	H [cm]	h [cm]
359.313.00.1	2290287	56	56	2"	6	1,8

Flensforbindelser

Geberit PE blindflens



click & scan

Art. nr.	NRF nr.	DN	d, ø [mm]	D [cm]	k [mm]	m [mm]	H [cm]	n [pc.]	PN [bar]
361.748.00.1	2293258	50	50	15	110	18	1,2	4	10
363.748.00.1	2293261	56 / 60	56 / 63	16,5	125	18	1,2	4	10
365.748.00.1	2293265	70	75	18,5	145	18	1,2	4	10
366.748.00.1	2293267	90	90	20	160	18	1,4	8	10
368.748.00.1	2293271	125	125	25	210	18	1,4	8	10
369.748.00.1	2293273	150	160	28,5	240	23	1,4	8	10
370.748.00.1	2293275	200	200	34	295	23	1,4	8	3,2
371.748.00.1	2293277	250	250	39,5	350	23	1,6	12	3,2
372.748.00.1	2293279	300	315	44,5	400	23	2	12	3,2

Bestilles i tillegg

- Geberit PE flenspakning → s. 253

Geberit PE sett flens

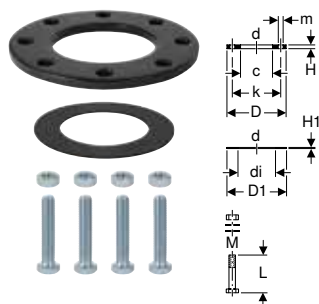

click & scan

Art. nr.	NRF nr.	DN	d, ø [mm]	M [mm]	di, ø [mm]	D [cm]	D1 [cm]	k [mm]	c [mm]	m [mm]	L [cm]	H [cm]	H1 [cm]	n [pc.]	PN [bar]
361.746.00.1	2290193	50	50	16	45	15	9,2	110	54	18	7	1,2	0,3	4	10
363.746.00.1	2290194	56 / 60	56 / 63	16	59	16,5	10,7	125	68	18	7	1,2	0,3	4	10
365.746.00.1	2290195	70	75	16	69	18,5	12,7	145	78	18	7	1,2	0,3	4	10
366.746.00.1	2290196	90	90	16	83	20	14,2	160	96	18	8	1,4	0,3	8	10
367.746.00.1	2290197	100	110	16	102	22	16,2	180	116	18	8	1,4	0,3	8	10
368.746.00.1	2290198	125	125	16	116	25	19,2	210	131	18	8	1,4	0,3	8	10
369.746.00.1	2290199	150	160	20	149	28,5	21,7	240	165	23	9	1,4	0,3	8	10
370.746.00.1	2290201	200	200	20	191	34	27,2	295	206	23	9	1,4	0,3	8	3,2
371.746.00.1	2290202	250	250	20	238	39,5	32,7	350	256	23	10	1,6	0,4	12	3,2
372.746.00.1	2290203	300	315	20	298	44,5	37,7	400	315	23	11	2	0,4	12	3,2



Geberit PE løsløse

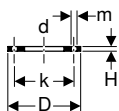

click & scan

Art. nr.	NRF nr.	DN	d, ø [mm]	D [cm]	k [mm]	m [mm]	H [cm]	n [pc.]	PN [bar]
361.745.00.1	2293158	50	50	15	110	18	1,2	4	10
363.745.00.1	2293161	56 / 60	56 / 63	16,5	125	18	1,2	4	10
365.745.00.1	2293165	70	75	18,5	145	18	1,2	4	10
366.745.00.1	2293167	90	90	20	160	18	1,4	8	10
367.745.00.1	2293169	100	110	22	180	18	1,4	8	10
368.745.00.1	2293172	125	125	25	210	18	1,4	8	10
369.745.00.1	2293174	150	160	28	240	23	1,4	8	10
370.745.00.1	2293176	200	200	34	295	23	1,4	8	3,2
371.745.00.1	2293178	250	250	39,5	350	23	1,6	12	3,2
372.745.00.1	2293181	300	315	44,5	400	23	2	12	3,2

Bestilles i tillegg

- Geberit PE flenspakning → s. 253

Geberit PE sveisekrage

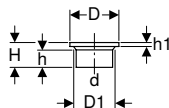

click & scan

Art. nr.	NRF nr.	DN	d, ø [mm]	D [cm]	D1 [cm]	H [cm]	h [cm]	h1 [cm]
361.744.16.1	2293108	50	50	8	5,4	6	4,2	0,8
363.744.16.1	2293111	56	56	9	6,8	6	3,6	0,8
364.744.16.1	2293113	60	63	9	6,8	6	3,7	0,8
365.744.16.1	2293115	70	75	11	7,8	6,5	4	0,9
366.744.16.1	2293117	90	90	12,8	9,6	7	4,4	1,1
367.744.16.1	2293119	100	110	14,8	11,6	7,5	4,8	1,2
368.744.16.1	2293122	125	125	16	13,1	8	5	1,4
369.744.16.1	2293124	150	160	19,8	16,5	9	5,1	1,7
370.744.16.1	2293126	200	200	26	20,6	7,8	5,4	1,4
371.744.16.1	2293128	250	250	32,5	25,6	7,8	5,2	1,6
372.744.16.1	2290354	300	315	37	31,5	10	7	2

Geberit PE sett skruer

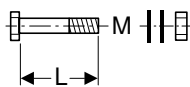
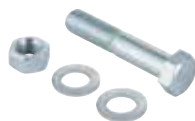

click & scan

Art. nr.	NRF nr.	Farge / overflate	d, ø [mm]	M [mm]	L [cm]
361.743.26.1	2290333	El-forsinket	50-75	16	7
366.743.26.1	2290334	El-forsinket	90-125	16	8
369.743.26.1	2290335	El-forsinket	160-200	20	9
371.743.26.1	2290336	El-forsinket	250	20	10
372.743.26.1	2290337	El-forsinket	315	20	11

Flensbøssinger

Geberit PE flenssemuffe

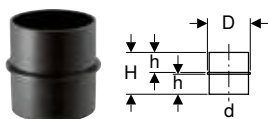

click & scan

Art. nr.	NRF nr.	DN	d, ø [mm]	D [cm]	H [cm]	h [cm]
379.772.16.1	2292534	30	32	3,8	5,2	2,4
360.772.16.1	2292536	40	40	4,7	6,8	3,2
361.772.16.1	2292538	50	50	5,7	6,8	3,2
363.772.16.1	2292541	56	56	6,5	5,8	2,7
364.772.16.1	2292543	60	63	7	7,2	3,4
365.772.16.1	2292545	70	75	9	7,2	3,4
366.772.16.1	2292547	90	90	10,3	9,2	4,4
367.772.16.1	2292549	100	110	12	11,7	5,6

Utstyrstilkoblinger

Tilslutningsbender

Geberit PE tilslutningsbend 45° med overgangsmuffe, for veggengt toalett

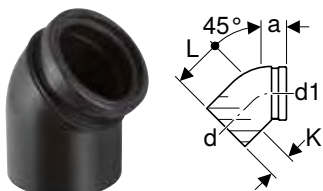

click & scan

Art. nr.	NRF nr.	DN	d, ø [mm]	d1, ø [mm]	a [cm]	L [cm]	K [cm]
367.945.16.1	6167405	100 / 90	110	90	6	8,7	3

Geberit PE tilslutningsbend 90° for pakningsring

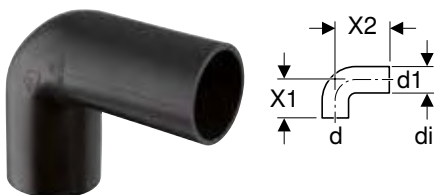

click & scan

Art. nr.	NRF nr.	DN	d, ø [mm]	d1, ø [mm]	di, ø [mm]	X1 [cm]	X2 [cm]
361.080.16.1	2290357	50	50	50	44	7,5	10

Bestilles i tillegg

- Pakningsring



Geberit PE tilslutningsbend 90° for pakningsring

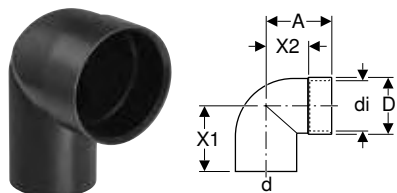

click & scan

Art. nr.	NRF nr.	DN	d, ø [mm]	A [cm]	di, ø [mm]	D [cm]	X1 [cm]	X2 [cm]
361.061.16.1	2290355	50	50	5	46	5,2	6	3
361.065.16.1	2290356	50	50	6	58	6,4	7	4

Bestilles i tillegg

- Pakningsring

Geberit PE tilslutningsbend 90° for veggengt toalett

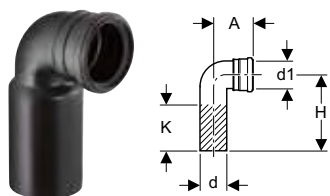

click & scan

Art. nr.	NRF nr.	DN	d, ø [mm]	d1, ø [mm]	A [cm]	H [cm]	K [cm]
366.061.16.1	6167051	90 / 90	90	90	11	22,5	13
367.070.16.1	2290377	100 / 90	110	90	12,1	22,5	13

Geberit PE tilslutningsbend 90° for veggengt toalett, med utvidelse

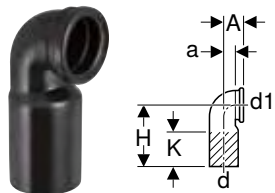

click & scan

Art. nr.	NRF nr.	DN	d, ø [mm]	d1, ø [mm]	A [cm]	a [cm]	H [cm]	K [cm]
366.925.16.1	2290358	90 / 90	90	90	7,8	4,5	22,5	13
367.792.16.1	6167406	100 / 100	110	110	7,5	4,5	22,5	13
367.925.16.1	6167402	100 / 90	110	90	7,5	4,5	22,5	13

Geberit PE tilslutningsbend 90° for veggengt toalett, krumt mot venstre, med utvidelse

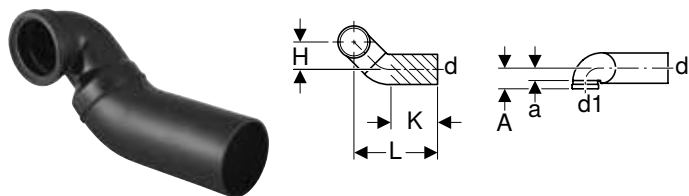

click & scan

Art. nr.	NRF nr.	DN	d, ø [mm]	d1, ø [mm]	A [cm]	a [cm]	L [cm]	H [cm]	K [cm]
366.913.16.1	2290006	90 / 90	90	90	7,8	4,5	29	10	15
367.913.16.1	2290996	100 / 90	110	90	7,5	4,5	32	10	17

Geberit PE tilslutningsbend 90° for vegghengt toalett, krumt mot høyre, med utvidelse

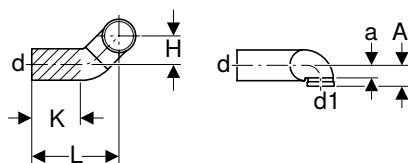

click & scan

Art. nr.	NRF nr.	DN	d, ø [mm]	d1, ø [mm]	A [cm]	a [cm]	L [cm]	H [cm]	K [cm]
366.914.16.1	2290005	90 / 90	90	90	7,8	4,5	29	10	15
367.914.16.1	2290998	100 / 90	110	90	7,5	4,5	32	10	17

Geberit PE tilslutningsbend 90° for toalett, kan trekkes ut

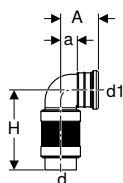

click & scan

Art. nr.	NRF nr.	DN	d, ø [mm]	d1, ø [mm]	A [cm]	a [cm]	H [cm]
241.521.00.1	6166445	90	90	90	11	4,8	25,5-45,5

Geberit PE dobbelgren 90°

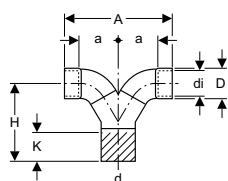

click & scan

Art. nr.	NRF nr.	DN	d, ø [mm]	arc [°]	A [cm]	a [cm]	d1, ø [mm]	D [cm]	H [cm]	K [cm]
363.463.16.1	2290177	56	56	90	17	6	46	5,2	12	4

Geberit PE dobbelgren 90° for vegghengt toalett

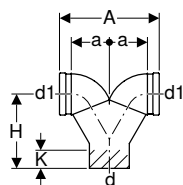

click & scan

Art. nr.	NRF nr.	DN	d, ø [mm]	d1, ø [mm]	arc [°]	A [cm]	a [cm]	H [cm]	K [cm]
367.923.16.1	6167401	100 / 90 / 90	110	90	90	27,5	10,5	32,5	19

Geberit PE dobbelgren 90° for pakningsring

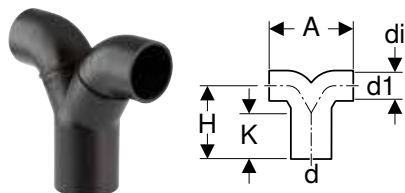

click & scan

Art. nr.	NRF nr.	DN	d, ø [mm]	d1, ø [mm]	arc [°]	A [cm]	di, ø [mm]	H [cm]	K [cm]
363.472.16.1	2290175	56 / 50	56	50	90	15,5	44	12	3
365.472.16.1	2290176	70 / 56	75	56	90	15,5	50	13,5	6

Bestilles i tillegg

- Pakningsring

Geberit PE dobbelgren 90° krumt, for vegghengt toalett

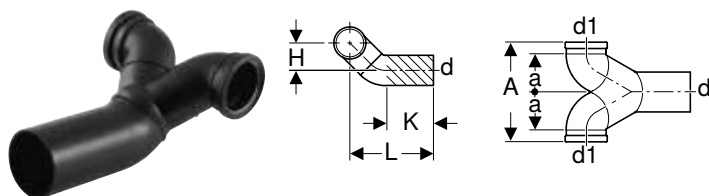

click & scan

Art. nr.	NRF nr.	DN	d, ø [mm]	d1, ø [mm]	arc [°]	A [cm]	a [cm]	L [cm]	H [cm]	K [cm]
367.485.16.1	6167404	100 / 90 / 90	110	90	90	27,5	10,5	34	10	12

Tilkoblingsmuffer

Geberit PE tilkoplingsmuffe

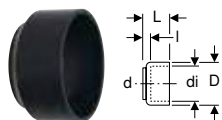

click & scan

Art. nr.	NRF nr.	DN	d, ø [mm]	di, ø [mm]	D [cm]	L [cm]	I [cm]
360.770.16.1	2291073	40	40	46	5,2	3,5	1

Geberit PE overgangsmuffe med O-ring

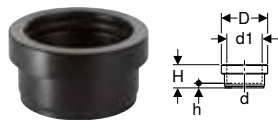

click & scan

Art. nr.	NRF nr.	DN	d, ø [mm]	d1, ø [mm]	D [cm]	H [cm]	h [cm]
361.768.16.1	2291036	50 / 40	50	45	6	3	0,5

Geberit PE lang tilkoplingsmuffe, med pakningsring, for gulvstående toalett



click & scan

Art. nr.	NRF nr.	DN	d, ø [mm]	di, ø [mm]	D [cm]	H [cm]	h [cm]
367.868.16.1	2290258	100	110	120	13,2	12	2

Geberit PE overgangsmuffe med leppepakning, for veggengt toalett



click & scan

Art. nr.	NRF nr.	DN	d, ø [mm]	d1, ø [mm]	D [cm]	L [cm]
366.941.16.1	2290278	90 / 90	90	90	11,1	4
367.941.16.1	2290281	100 / 90	110	90	11,1	4
367.794.16.1	2290279	100 / 100	110	110	13,1	4,1

Tilkoblingsrør

Geberit PE tilkoblingsrør med stikkuffe, for veggengt toalett

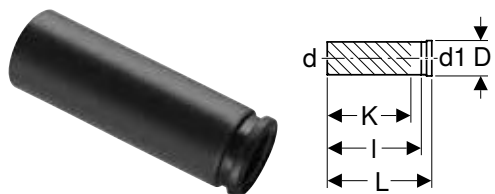

click & scan

Art. nr.	NRF nr.	DN	d, ø [mm]	d1, ø [mm]	D [cm]	L [cm]	I [cm]	K [cm]
366.887.16.1	6167414	90 / 90	90	90	11,2	31	27,5	24
367.887.16.1	6167411	100 / 90	110	90	11,2	34,5	31,5	28

Rørbendvannlåser

Geberit PE vannlås

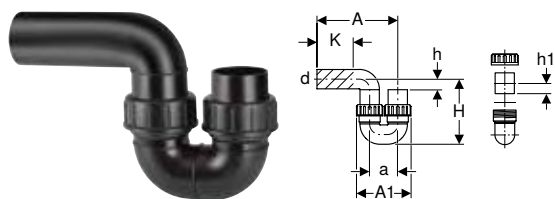

click & scan

Art. nr.	NRF nr.	DN	d, ø [mm]	Avløpskapasitet [l/s]	A [cm]	A1 [cm]	a [cm]	H [cm]	h [cm]	h1 [cm]	K [cm]
364.730.16.1	2290367	60	63	1,4	30,5	18,5	9,5	20,5	5	3,4	16
365.730.16.1	4520755	70	75	2,4	34,5	25	13,5	29,5	7	3,4	14
367.730.16.1	2290368	100	110	5,9	46	31	16	31,5	6	5,6	22

Spiralvannlåser

Geberit PE spiralvannlås med serviceåpning

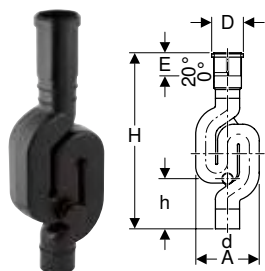

click & scan

Art. nr.	NRF nr.	DN	d, ø [mm]	Avløpskapasitet [l/s]	G ["]	A [cm]	D [cm]	E [cm]	H [cm]	h [cm]
365.813.16.1	2290342	70	75	3,8	2 1/2"	19,8	9,8	8-10,5	66,7	16,6
367.813.16.1	2290343	100	110	9,6	4"	28,8	13,6	8-10,5	80,8	21,7

Tilbehør

Klammer

Geberit klammer med gjenget rørmuffe G 1/2", justerbar



click & scan

Art. nr.	NRF nr.	Farge / overflate	DN	G ["]	di, ø [mm]	di, ø [mm]	L1 [cm]	L2 [cm]	B [cm]
360.841.00.2	2272255	El-forsinket	40	1/2"	40	48	3,8	4,2	3
361.841.00.2	2272259	El-forsinket	50	1/2"	50	58	4,3	4,7	3
363.841.00.2	2290127	El-forsinket	56	1/2"	56	64	4,6	5	3
364.841.00.2	2272269	El-forsinket	60	1/2"	63	71	5	5,4	3
365.841.00.2	2272274	El-forsinket	70	1/2"	75	83	5,6	6	3
366.841.00.2	2272279	El-forsinket	90	1/2"	90	98	6,3	6,7	3
367.841.00.2	2272284	El-forsinket	100	1/2"	110	118	7,3	7,7	3
368.841.00.2	2272289	El-forsinket	125	1/2"	125	133	8,1	8,5	3
369.841.00.2	2272294	El-forsinket	150	1/2"	160	168	9,8	10,2	3

Geberit klammer med gjenget rørmuffe M10, justerbar

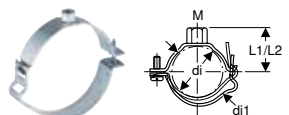

click & scan

Art. nr.	NRF nr.	Farge / overflate	DN	M [mm]	di, ø [mm]	di, ø [mm]	L1 [cm]	L2 [cm]	B [cm]
360.843.00.2	2290123	El-forsinket	40	10	40	48	3,5	3,9	3
361.843.00.2	2290125	El-forsinket	50	10	50	58	4	4,4	3
363.843.00.2	2290128	El-forsinket	56	10	56	64	4,3	4,7	3
364.843.00.2	2290131	El-forsinket	60	10	63	71	4,7	5,1	3
365.843.00.2	2290133	El-forsinket	70	10	75	83	5,3	5,7	3
366.843.00.2	2290135	El-forsinket	90	10	90	98	6	6,4	3
367.843.00.2	2290137	El-forsinket	100	10	110	118	7	7,4	3
368.843.00.2	2290139	El-forsinket	125	10	125	133	7,8	8,2	3



- Egner seg ikke for bruk som fastpunkt

Geberit klammer med gjenget rørmuffe G 3/4", justerbar

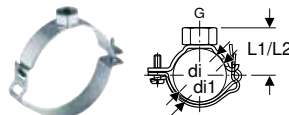

click & scan

Art. nr.	NRF nr.	Farge / overflate	DN	G ["]	di, ø [mm]	di, ø [mm]	L1 [cm]	L2 [cm]	B [cm]
363.842.00.1	2290095	El-forsinket	56	3/4"	56	64	4,8	5,2	3
364.842.00.1	2290096	El-forsinket	60	3/4"	63	71	5,2	5,6	3
365.842.00.1	2290098	El-forsinket	70	3/4"	75	83	5,8	6,2	3
366.842.00.1	2290101	El-forsinket	90	3/4"	90	98	6,5	6,9	3
367.842.00.1	2290103	El-forsinket	100	3/4"	110	118	7,5	7,9	3
368.842.00.1	2290105	El-forsinket	125	3/4"	125	133	8,3	8,7	3
369.842.00.1	2290107	El-forsinket	150	3/4"	160	168	10	10,4	3

Geberit klammer med gjenget rørmuffe G 1"

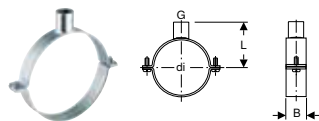

click & scan

Art. nr.	NRF nr.	Farge / overflate	DN	G ["]	di, ø [mm]	L [cm]	B [cm]
370.840.00.1	2290142	El-forsinket	200	1"	200	14,8	4
371.840.00.1	2290378	El-forsinket	250	1"	250	17,3	4
372.840.00.1	2290381	El-forsinket	300	1"	315	20,5	4

Geberit klammer med gjenget rørmuffe G 1 1/4"

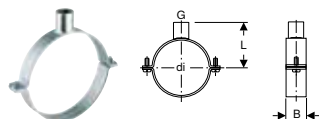

click & scan

Art. nr.	NRF nr.	Farge / overflate	DN	G ["]	di, ø [mm]	L [cm]	B [cm]
371.841.00.1	2290379	El-forsinket	250	1 1/4"	250	17,3	4
372.841.00.1	2290382	El-forsinket	300	1 1/4"	315	20,5	4

Geberit klammer med gjenget rørmuffe M8 / M10

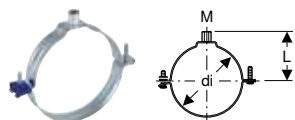

click & scan

Art. nr.	NRF nr.	Farge / overflate	M [mm]	di, ø [mm]	L [cm]
360.832.00.2	2290122	El-forsinket	8 / 10	40	4,3
361.832.00.2	2290124	El-forsinket	8 / 10	50	4,8
363.832.00.2	2290126	El-forsinket	8 / 10	56	5,1
364.832.00.2	2290129	El-forsinket	8 / 10	63	5,5
365.832.00.2	2290132	El-forsinket	8 / 10	75	6,1
366.832.00.2	2290134	El-forsinket	8 / 10	90	6,8
367.832.00.2	2290136	El-forsinket	8 / 10	110	7,8
368.832.00.2	2290138	El-forsinket	8 / 10	125	8,6
369.832.00.2	2290141	El-forsinket	8 / 10	160	10,3

Fester for klammer

Geberit PE dobbel flensforing

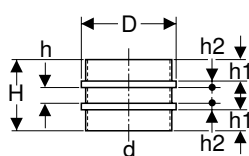

click & scan

Art. nr.	NRF nr.	DN	d, ø [mm]	D [cm]	H [cm]	h [cm]	h2 [cm]	h1 [cm]
370.751.16.1	2290172	200	200	21,3	19,1	4,1	1,5	6
371.751.16.1	2290173	250	250	26,2	20,1	4,1	2	6
372.751.16.1	2290174	300	315	32,6	20,1	4,1	2	6

Geberit fastpunkt-sveisebånd

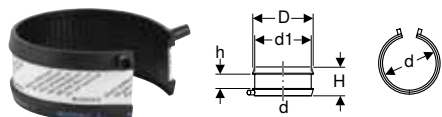

click & scan

Art. nr.	NRF nr.	DN	d, ø [mm]	d1, ø [mm]	D [cm]	H [cm]	h [cm]
361.776.16.1	2290112	50	50	58	6,6	6	3
363.776.16.1	2290113	56	56	64	7,2	6	3
364.776.16.1	2290114	60	63	71	7,9	6	3
365.776.16.1	2290007	70	75	83	9,1	6	3
366.776.16.1	2290115	90	90	98	10,6	6	3
367.776.16.1	2290116	100	110	118	12,6	6	3
368.776.16.1	2290008	125	125	133	14,1	6	3
369.776.16.1	2290117	150	160	168	17,6	6	3
370.776.16.1	2290118	200	200	208	21,6	6	3
371.776.16.1	2290119	250	250	258	26,6	6	3

Geberit sett fikspunkt-sveisebånd

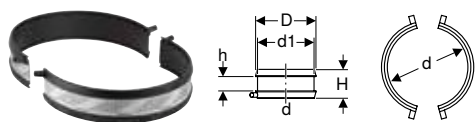

click & scan

Art. nr.	NRF nr.	DN	d, ø [mm]	d1, ø [mm]	D [cm]	H [cm]	h [cm]
372.776.16.1	2290121	300	315	323	33,1	6	3

Geberit bunnplate rektangulær, to hull, med gjenget rørmuffe M10 / G 1/2"

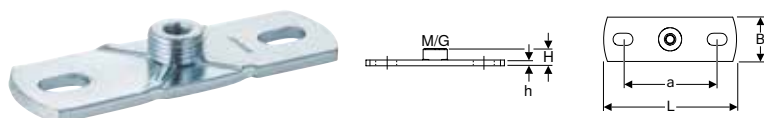

click & scan

Art. nr.	NRF nr.	G ["]	M [mm]	a [cm]	L [cm]	B [cm]	H [cm]	h [cm]
362.851.26.1	2290374	1/2"	10	8,5	12	4	1,5	0,5

Geberit bunnplate rektangulær, to hull, med gjenget rørmuffe M8/M10

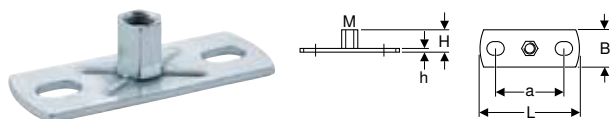

click & scan

Art. nr.	NRF nr.	M [mm]	a [cm]	L [cm]	B [cm]	H [cm]	h [cm]
362.848.26.1	2290373	8 / 10	5,4	8	3	1,9	0,3

Geberit bunnplate rektangulær, to hull, med gjenget rørmuffe G

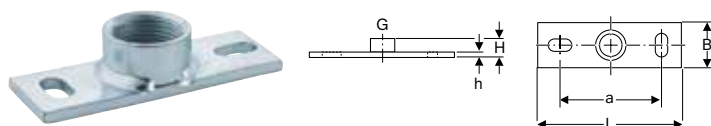

click & scan

Art. nr.	NRF nr.	G ["]	a [cm]	L [cm]	B [cm]	H [cm]	h [cm]
362.826.26.1	2290369	1/2"	9	12	4	2,1	0,6
362.827.26.1	2290371	3/4"	9	12	4	2,3	0,6
362.828.26.1	2290372	1"	9	12	4	2,6	0,6

Geberit rund grunnplate, tre hull, med gjenget rørmuffe M10

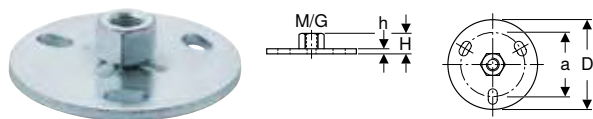

click & scan

Art. nr.	NRF nr.	M [mm]	a [cm]	D [cm]	H [cm]	h [cm]
362.837.26.1	2290375	10	5	7	1,6	0,4

Geberit rund grunnplate, tre hull med gjenget rørmuffe G 1/2"

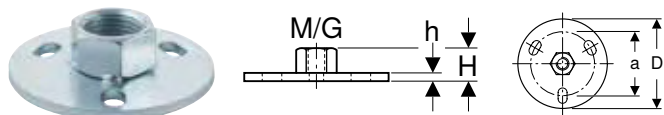

click & scan

Art. nr.	NRF nr.	G ["]	a [cm]	D [cm]	H [cm]	h [cm]
362.839.26.1	2290376	1/2"	5	7	1,9	0,4

Geberit gjengestag



click & scan

Art. nr.	NRF nr.	M [mm]	L [cm]
362.836.00.1	2294555	10	50

Geberit gjengestag

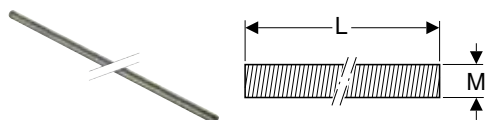

click & scan

Art. nr.	NRF nr.	Farge / overflate	M [mm]	L [cm]
362.834.26.1	2290088	El-forsinket	10	200

Geberit gjenget rør

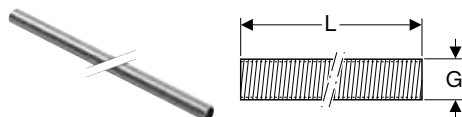

click & scan

Art. nr.	NRF nr.	Farge / overflate	G ["]	L [cm]
362.852.26.1	2290092	El-forsinket	1/2"	200
362.853.26.1	2290093	El-forsinket	3/4"	200
362.854.26.1	2290094	El-forsinket	1"	200

Geberit forbindelsesmuffe



click & scan

Art. nr.	NRF nr.	Farge / overflate	G ["]	M [mm]	L [cm]
362.843.26.1	2290089	El-forsinket		10	3
362.844.26.1	2290091	El-forsinket	1/2"		3,4

Geberit kombiskrue



click & scan

Art. nr.	NRF nr.	L [cm]
362.833.00.1	2294551	10

Bærende strukturer

Geberit bæreskall forsinket og lakkert

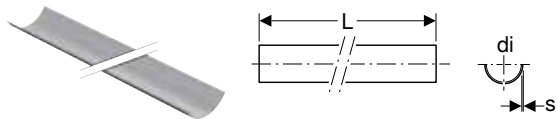

click & scan

Art. nr.	Farge / overflate	DN	di, \emptyset [mm]	s [mm]	L [m]
360.850.00.1	Lakkert	40	40	0,75	3
361.850.00.1	Lakkert	50	50	0,75	3
363.850.00.1	Lakkert	56	56	0,75	3
364.850.00.1	Lakkert	60	63	0,75	3
365.850.00.1	Lakkert	70	75	0,75	3
366.850.00.1	Lakkert	90	90	0,75	3
367.850.00.1	Lakkert	100	110	0,75	3
368.850.00.1	Lakkert	125	125	0,75	3
369.850.00.1	Lakkert	150	160	0,75	3
370.850.00.1	Lakkert	200	200	0,75	3
372.850.00.1	Lakkert	300	315	0,75	3

Endedeksler

Geberit PE lokk for sveising



click & scan

Art. nr.	NRF nr.	DN	d, ø [mm]
360.812.16.1	2293643	40	40
361.812.16.1	2293645	50	50
363.812.16.1	2293647	56	56
364.812.16.1	2293649	60	63
365.812.16.1	2293652	70	75
366.812.16.1	2293654	90	90
367.812.16.1	2293656	100	110
368.812.16.1	2293658	125	125
369.812.16.1	2293661	150	160
370.812.16.1	2290259	200	200

Geberit PE beskyttelseskappe for rørende

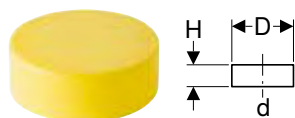

click & scan

Art. nr.	NRF nr.	Farge / overflate	DN	d, ø [mm]	D [cm]	H [cm]
361.802.92.1	2293604	Gul	50	50	5,2	3,5
366.802.92.1	2293612	Gul	90	90	9,3	3,5
367.802.92.1	2290157	Gul	100	110	11,3	4
369.802.92.1	2290158	Gul	150	160	16,4	3

Geberit PE skrulokk for stakeluker



click & scan

Art. nr.	NRF nr.	DN	d, ø [mm]
367.809.16.1	2290338	125-150	125-160

Geberit PE skrulokk for stakeluker



click & scan

Art. nr.	NRF nr.	d, ø [mm]
367.810.16.1	2290339	110

Pakninger

Geberit PE O-ring



click & scan

Art. nr.	NRF nr.	DN	d, ø [mm]
362.790.00.1	2290268	30	32
362.769.00.1	2290267	40	45
361.789.00.1	2290266	50	50
363.789.00.1	2290269	56	56
364.789.00.1	2290271	60	63
365.789.00.1	2292435	70	75
366.789.00.1	2290272	90	90
367.988.00.1	2290273	80	90
367.789.00.1	2292439	100	110
368.789.00.1	2290274	125	125

Geberit leppepakning for spylør



click & scan

Art. nr.	NRF nr.	DN	d, ø [mm]
362.771.00.1	6167057	40	45

Geberit PE pakningsring



click & scan

Art. nr.	NRF nr.	DN	d, ø [mm]
242.923.00.1	2290309	40	40
242.924.00.1	2290311	50	50
242.925.00.1	2290312	56	56
242.926.00.1	2290313	60	63
242.927.00.1	2290314	70	75
242.928.00.1	2290315	90	90
242.929.00.1	2290316	100	110
242.930.00.1	2290317	125	125
242.931.00.1	2290318	150	160

Geberit PE pakningsring



click & scan

Art. nr.	NRF nr.	DN	d, ø [mm]
853.524.00.1	2290321	56	56

Geberit PE pakningsring



click & scan

Art. nr.	NRF nr.	DN	d, ø [mm]
387.282.00.1	2290319	90	90

Geberit pakningsring



click & scan

Art. nr.	NRF nr.	d, ø [mm]	d1, ø [mm]	L [cm]
152.796.00.1	2291114	40	44	2,3
152.495.00.1	2291113	32	46	2,3
152.496.00.1	2291115	40	46	2,3
153.564.16.1	2291112	32	58	2,3
153.565.16.1	2291116	40	58	2,3
153.566.16.1	2291122	50	58	2,3

Geberit pakningsring

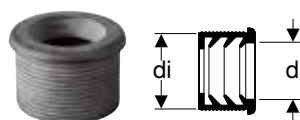

click & scan

Art. nr.	NRF nr.	DN	d, ø [mm]	di, ø [mm]
152.682.00.1		50	32	44
152.689.00.1	2294466	56	32	50
152.690.00.1	2294469	56	40	50
152.691.00.1	2294473	60	32	57
152.692.00.1	2294476	60	40	57
152.693.00.1	2294479	60	50	57

Geberit PE flenspakning



click & scan

Art. nr.	NRF nr.	DN	d, ø [mm]	di, ø [mm]	D [cm]	H [cm]
361.742.00.1	2293208	50	50	45	9,2	0,3
363.742.00.1	2293211	56-60	56-63	59	10,7	0,3
365.742.00.1	2293215	70	75	69	12,7	0,3
366.742.00.1	2293217	90	90	83	14,2	0,3
367.742.00.1	2293219	100	110	102	16,2	0,3
368.742.00.1	2293222	125	125	116	19,2	0,3
369.742.00.1	2293224	150	160	149	21,7	0,3

Geberit kompresjonspakning



click & scan

Art. nr.	NRF nr.	d, ø [mm]	di, ø [mm]
364.783.00.1	2290143	63	59

Geberit PE kompresjonspakning



click & scan

Art. nr.	NRF nr.	DN	d, ø [mm]
360.783.00.1	2290227	40	40
361.783.00.1	2290228	50	50
363.783.00.1	2290229	56	56
365.783.00.1	2290231	70	75
366.783.00.1	2290232	90	90

Geberit slipering



click & scan

Art. nr.	DN	d, ø [mm]
379.782.16.1	30	32
360.782.16.1	40	40
361.782.16.1	50	50
363.782.16.1	56	56
364.782.16.1	60	63
365.782.16.1	70	75
366.782.16.1	90	90
367.782.16.1	100	110

Geberit leppetetning i EPDM



click & scan

Art. nr.	NRF nr.	DN	d, ø [mm]
242.278.00.1		30	32
241.785.00.1		40	40
241.786.00.1		50	50
241.787.00.1		70	75
241.790.00.1		90	90
241.791.00.1	2293894	100	110
242.279.00.1		125	125
242.280.00.1		150	160

Beskyttelseskapper

Geberit beskyttelsesplugg

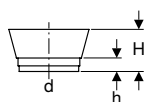

click & scan

Art. nr.	NRF nr.	Farge / overflate	DN	d, ø [mm]	H [cm]	h [cm]
366.820.92.1	2290111	Gul	90	90	8,3	3,3

Geberit beskyttelsesplugg

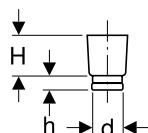

click & scan

Art. nr.	NRF nr.	Farge / overflate	DN	d, ø [mm]	H [cm]	h [cm]
362.796.92.1	2290109	Gul	40	44,6	8	2

Forbruksmateriell

Geberit glidemiddel 250 ml



click & scan

Art. nr.	NRF nr.
953.761.00.1	2293918

Geberit markeringspenn med justerbar fettstift



click & scan

Art. nr.	Farge / overflate
690.102.00.1	Gul

Tilbehør

- Geberit reserve fettstift for markeringspenn med justerbar fettstift → s. 187

Geberit reserve fettstift for markeringspenn med justerbar fettstift



click & scan

Art. nr.	Farge / overflate
690.103.00.1	Gul

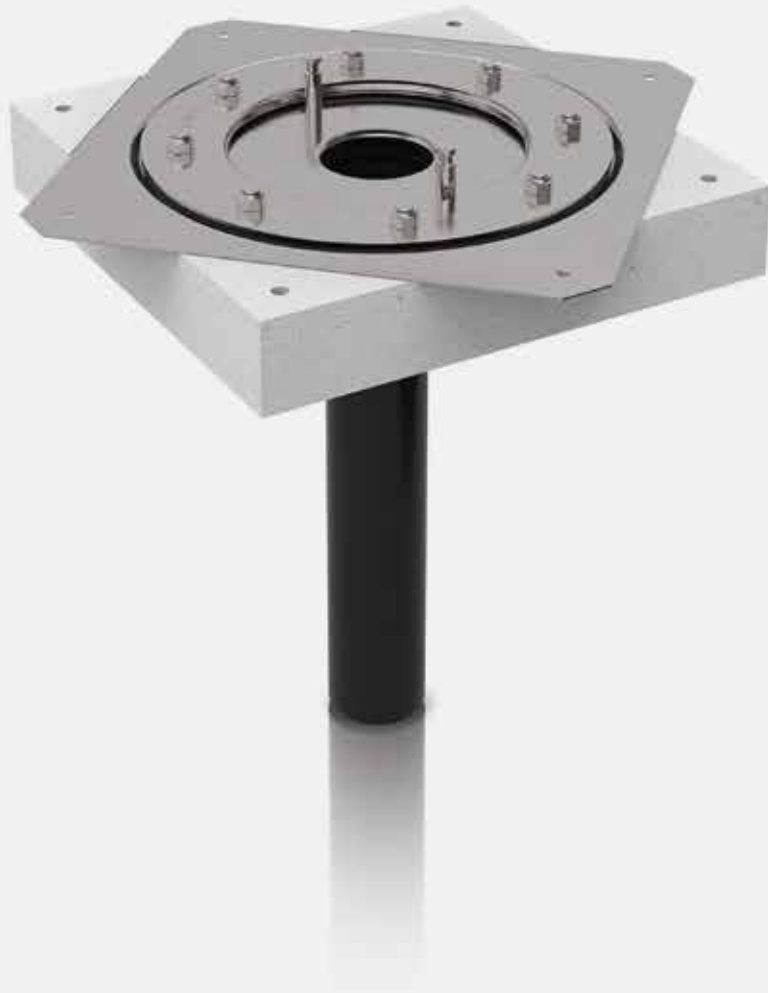
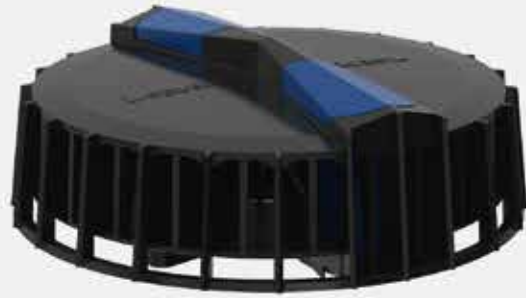

Geberit Pluvia takdrenering

Sortimentsoversikt – Geberit Pluvia takdrenering.....	258
Takavløp.....	259
Takavløp opptil 12 l/s	259
Takavløp opptil 25 l/s	260
Takavløp for renner	261
Takavløp opptil 12 l/s	261
Takavløp opptil 25 l/s	261
Dampsperrelementer	262
For takavløp opptil 12 l/s	262
Nødoverløp	262
For takavløp opptil 12 l/s	262
Fester.....	262
Festesystem d40–200	262
Tilbehør	264
For takavløp.....	264
For fester	267



Sortimentsoversikt – Geberit Pluvia takdrenering

Geberit Norge, Versjon: oktober 2023

Installasjon	Vannførende nivå	Tilkoblingstype		Maksimal utløpskapasitet							
				9 l/s	12 l/s	19 l/s	25 l/s	45 l/s	60 l/s	100 l/s	
Flatt tak	Bitumen	Bitumen-bane	359.115.00.1 Geberit Pluvia takavløp med bitumen-bane, perforert		✓						
Flatt tak	Taktekkingsfolie	Flens	359.117.00.1 Geberit Pluvia takavløp med flens, for taktekkingsfolier	✓							
Flatt tak			359.105.00.1 Geberit Pluvia takavløp med flens, for taktekkingsfolier		✓						
Flatt tak			359.098.00.1 Geberit Pluvia takavløp med flens, for taktekkingsfolier					✓			
Flatt tak	Taktekkingsfolie eller bitumen	Kontaktfolie	359.118.00.1 Geberit Pluvia takavløp	✓							
Flatt tak			359.107.00.1 Geberit Pluvia takavløp			✓					
Renne		Kontaktplate	359.111.00.1 Geberit Pluvia takavløp med tilkoplingsstykke for renner		✓						
Renne			359.100.00.1 Geberit Pluvia takavløp med tilkoplingsstykke for renner					✓			
Renne		Flens	359.112.00.1 Geberit Pluvia takavløp med flens, for renner		✓						

✓ Kompatibel

Takavløp

Takavløp opptil 12 l/s

Geberit Pluvia takavløp med flens, for taktekkingsfolier

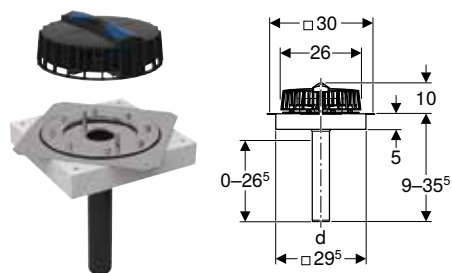

click & scan

Art. nr.	NRF nr.	DN	Tilkobling tetting	d, ø [mm]
359.105.00.1	3406404	56	CrNi-stål 1.4301	56

Geberit Pluvia takavløp

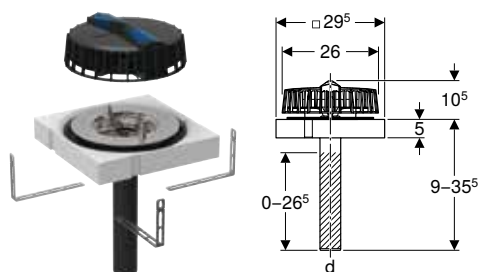

click & scan

Art. nr.	DN	d, ø [mm]
359.107.00.1	56	56

Tilbehør

- Geberit Pluvia folie taktekkingsfolier → s. 264
- Geberit Pluvia festeplate → s. 265
- Geberit Pluvia universalmembran → s. 265
- Geberit Pluvia folie til bitumen → s. 264

Geberit Pluvia takavløp med flens, for taktekkingsfolier

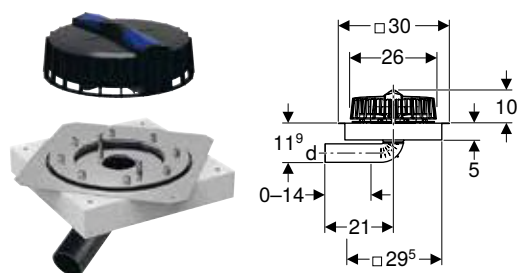

click & scan

Art. nr.	NRF nr.	DN	Tilkobling tetting	d, ø [mm]
359.117.00.1	3406801	56	CrNi-stål 1.4301	56



Geberit Pluvia takdrenering

Takavløp

Takavløp opptil 25 l/s

Geberit Pluvia takavløp

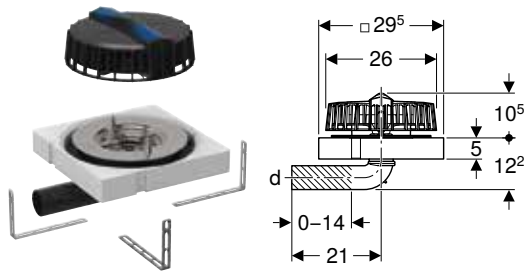

click & scan

Art. nr.	DN	d, ø [mm]
359.118.00.1	56	56

Tilbehør

- Geberit Pluvia folie taktekkingsfolier → s. 264
- Geberit Pluvia universalmembran → s. 265
- Geberit Pluvia folie til bitumen → s. 264

Geberit Pluvia takavløp med bitumen-bane, perforert

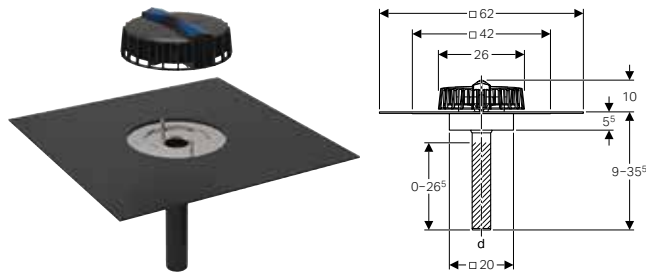

click & scan

Art. nr.	NRF nr.	DN	Tilkobling tetting	d, ø [mm]
359.115.00.1	3406403	56	Bitumen / SBS	56

Takavløp opptil 25 l/s

Geberit Pluvia takavløp med flens, for taktekkingsfolier

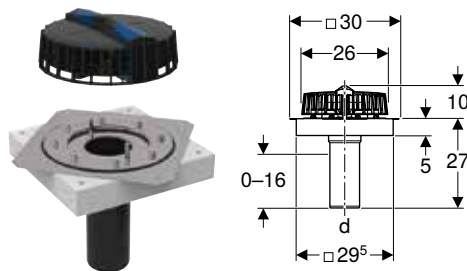

click & scan

Art. nr.	DN	Tilkobling tetting	d, ø [mm]
359.098.00.1	90	CrNi-stål 1.4301	90

Takavløp for renner

Takavløp opptil 12 l/s

Geberit Pluvia takavløp med tilkoplingsstykke for renner

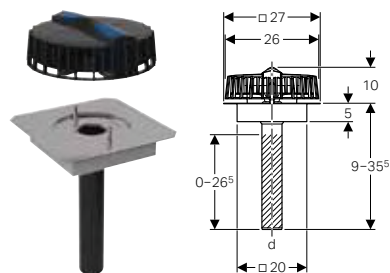

click & scan

Art. nr.	DN	Tilkobling tetting	d, Ø [mm]
359.111.00.1	56	CrNi-stål 1.4301	56

Geberit Pluvia takavløp med flens, for renner

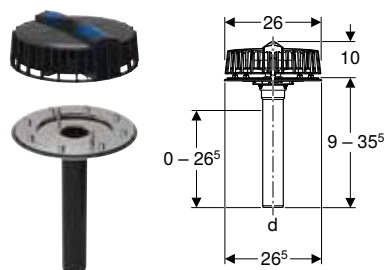

click & scan

Art. nr.	DN	Tilkobling tetting	d, Ø [mm]
359.112.00.1	56	CrNi-stål 1.4301	56

Takavløp opptil 25 l/s

Geberit Pluvia takavløp med tilkoplingsstykke for renner

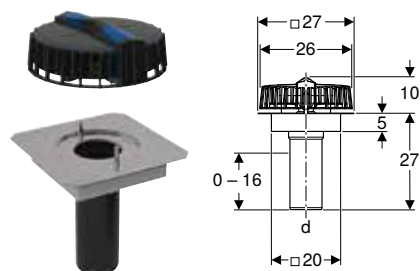

click & scan

Art. nr.	DN	Tilkobling tetting	d, Ø [mm]
359.100.00.1	90	CrNi-stål 1.4301	90



Dampsperrelementer

For takavløp oppti 12 l/s

Geberit Pluvia tilkopling av dampsperre

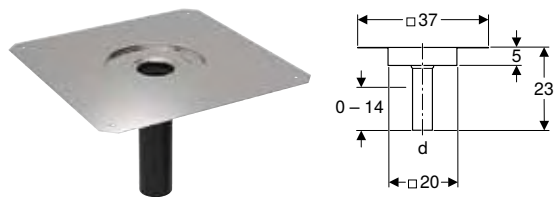

click & scan

Art. nr.	DN	Tilkobling tetting	d, ø [mm]
359.113.00.1	56	CrNi-stål 1.4301	56

Tilbehør

- Geberit Pluvia festeplate → s. 265

Nødoverløp

For takavløp oppti 12 l/s

Geberit Pluvia nødoverløp

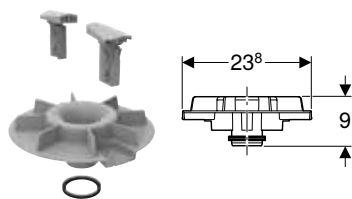

click & scan

Art. nr.
359.114.00.1

Fester

Festesystem d40–200

Geberit Pluvia bæreskinne

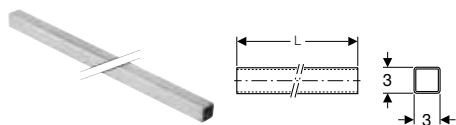

click & scan

Art. nr.	NRF nr.	Farge / overflate	L [m]	H [cm]
362.863.26.1	3406807	El-forsinket	5	3

Geberit Pluvia forbindelselement

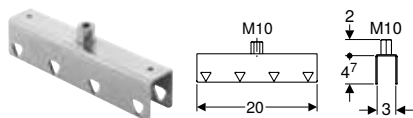

click & scan

Art. nr.	NRF nr.	Farge / overflate	L [cm]
362.864.26.1	3406808	El-forsinket	20

Geberit Pluvia opphengsdel

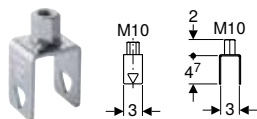

click & scan

Art. nr.	NRF nr.	Farge / overflate	L [cm]
362.862.26.1	3406806	El-forsinket	6,7

Geberit Pluvia festekile

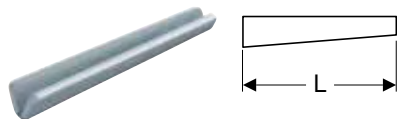

click & scan

Art. nr.	NRF nr.	Farge / overflate	L [cm]
362.865.26.1	3406809	El-forsinket	9

Geberit Pluvia klammer

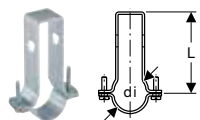

click & scan

Art. nr.	NRF nr.	Farge / overflate	DN	di, ø [mm]	L [cm]
360.861.00.1	3406804	El-forsinket	40	40	10,6

Geberit Pluvia justerbar klammer

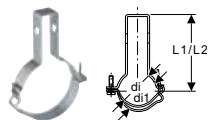

click & scan

Art. nr.	NRF nr.	Farge / overflate	DN	di, ø [mm]	di, ø [mm]	L1 [cm]	L2 [cm]
361.861.00.1	3406805	El-forsinket	50	50	58	11,3	11,7
363.861.00.1	3406811	El-forsinket	56	56	64	11,7	12,1
364.861.00.1	3406812	El-forsinket	60	63	71	12,1	12,5
365.861.00.1	3406813	El-forsinket	70	75	83	12,8	13,2
366.861.00.1	3406814	El-forsinket	90	90	98	13,6	14
367.861.00.1	3406815	El-forsinket	100	110	118	14,7	15,1
368.861.00.1	3406816	El-forsinket	125	125	133	15,5	15,9
369.861.00.1	3406817	El-forsinket	150	160	168	17,3	17,7

Geberit Pluvia justerbar klammer, med sikringsbøyle

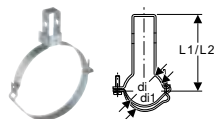

click & scan

Art. nr.	NRF nr.	Farge / overflate	DN	di, ø [mm]	di, ø [mm]	L1 [cm]	L2 [cm]
370.861.26.1	3406818	El-forsinket	200	200	208	19,4	19,8



Geberit fastpunkt-sveisebånd

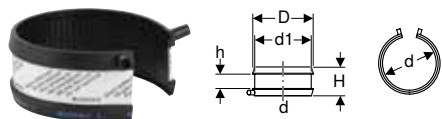

click & scan

Art. nr.	NRF nr.	DN	d, ø [mm]	d1, ø [mm]	D [cm]	H [cm]	h [cm]
361.776.16.1	2290112	50	50	58	6,6	6	3
363.776.16.1	2290113	56	56	64	7,2	6	3
364.776.16.1	2290114	60	63	71	7,9	6	3
365.776.16.1	2290007	70	75	83	9,1	6	3
366.776.16.1	2290115	90	90	98	10,6	6	3
367.776.16.1	2290116	100	110	118	12,6	6	3
368.776.16.1	2290008	125	125	133	14,1	6	3
369.776.16.1	2290117	150	160	168	17,6	6	3
370.776.16.1	2290118	200	200	208	21,6	6	3
371.776.16.1	2290119	250	250	258	26,6	6	3

Tilbehør

For takavløp

Geberit Pluvia folie taktekkingsfolier



click & scan

Art. nr.	NRF nr.	Tilkobling tetting
359.575.00.1	3407955	PVC (Sarnafil G 410-18)
359.577.00.1		EPDM (Resistit® Perfekt E)
359.591.00.1		FPO-A (Sarnafil TG 66)

Geberit Pluvia folie til bitumen

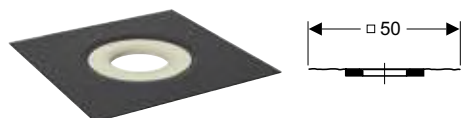

click & scan

Art. nr.	Tilkobling tetting
358.033.00.1	Bitumen (Sopralen EP5)

Geberit Pluvia bøyeelig tilkoplingsrør



click & scan

Art. nr.	DN	d, ø [mm]	D [cm]	L [m]
360.822.00.1	40	40	4,6	1,1
361.822.00.1	50	50	5,8	1,1
363.822.00.1	56	56	6,5	1,1
364.822.00.1	60	63	7,4	1,1
365.822.00.1	70	75	8,9	1,1

Geberit Pluvia festeplate

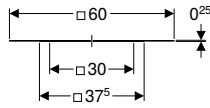

click & scan

Art. nr.	s [mm]
359.122.00.1	1,5

Geberit Pluvia universalmembran

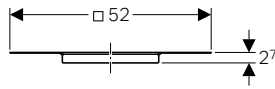

click & scan

Art. nr.	Tilkobling tetting	s [mm]
359.119.00.1	CrNi-stål 1.4404	1

Geberit Pluvia perforert tilkoplingsstykke, med bitumen-bane

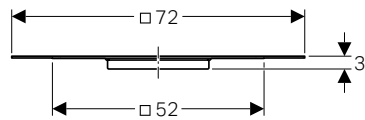
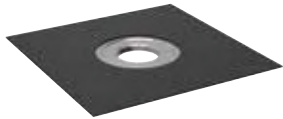

click & scan

Art. nr.	Tilkobling tetting
359.120.00.1	Bitumen / SBS

Geberit Pluvia støyreduksjonsinnsats for takavløp



click & scan

Art. nr.	NRF nr.
359.126.00.1	3406802

Geberit Pluvia varmeelement 230 V/8 W

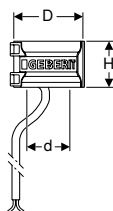

click & scan

Art. nr.	NRF nr.	d, \emptyset [mm]	D [cm]	H [cm]
359.971.00.1	3406803	56	9,7	6

Geberit Pluvia takdrenering

Tilbehør
For takavløp

Geberit varmetape 230 V / 11,2 W



click & scan

Art. nr.

359.042.00.1

Geberit Pluvia tilbehørssett som kan kjøres på

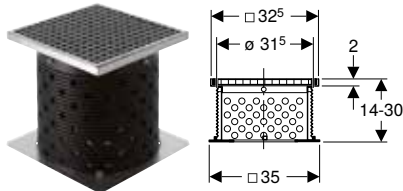

click & scan

Art. nr.

d, ø
[mm]

359.635.00.1

31,5

Geberit Pluvia tilbehørssett som kan gås på

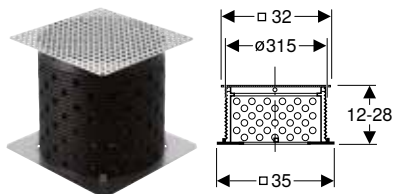

click & scan

Art. nr.

d, ø
[mm]

359.504.00.1

31,5

Geberit Pluvia grusring

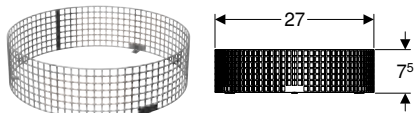

click & scan

Art. nr.

359.124.00.1

Løvfanger av støpt aluminium, for Geberit Pluvia takavløp med flens, for taktekkingsfolier



click & scan

Art. nr.

359.067.00.1

Geberit Pluvia varmeisolering

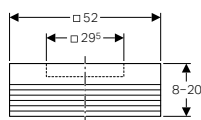
[click & scan](#)

Art. nr.	d, ø [mm]
359.123.00.1	56

For fester

Geberit Pluvia støttesett

[click & scan](#)

Art. nr.	NRF nr.	DN	d, ø [mm]
358.061.00.1	3406424	90–200	90–200

Bestilles i tillegg

- Gjenget rør G 1/2" L200, galvanisert (artikkelnummer 362.852.26.1)

Geberit Pluvia støttesett

[click & scan](#)

Art. nr.	NRF nr.	DN	d, ø [mm]
358.062.00.1	3406425	250–300	250–315

Bestilles i tillegg

- Gjenget rør G 1/2" L200, galvanisert (artikkelnummer 362.852.26.1)





Brannvern, lydisolering og fuktighetsvern

Brannvern	270
Brannvern for avløpssystemer.....	270
Lydisolering	270
Isoleringer for strukturlydtkobling.....	270
Isoleringer for strukturlydtkobling og luftlydisolering.....	271



Brannvern

Brannvern for avløpssystemer

Geberit brannmansjett RS90 Plus EN

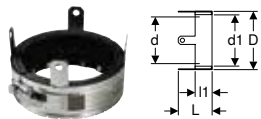

click & scan

Art. nr.	NRF nr.	DN	d, ø [mm]	d1, ø [mm]	D [cm]	L [cm]	l1 [cm]
348.300.00.1	2293895	40-56	40-56	63	7,8	8,5	5
348.301.00.1	2293896	60 / 70	63 / 75	83	10,2	8,5	5
348.302.00.1	2293897	90	90	98	11,9	8,5	5
348.303.00.1	2293898	100	110	118	14,5	8,5	5
348.304.00.1	2293899	125	125 / 135	141	17	10,5	7
348.305.00.1	2293901	150	160	169	20,6	11,5	8
348.306.00.1	2293902	200	200	207	27,2	12,5	9

Lydisolering

Isoleringer for strukturlydutkobling

Geberit isolasjonsslange av PE

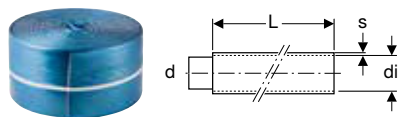

click & scan

Art. nr.	NRF nr.	DN	d, ø [mm]	di, ø [mm]	s [mm]	L [m]
305.921.00.1	2294029	56 / 60	56 / 63	74	4	15
306.921.00.1	2294566	60 / 70	63 / 75	83	4	15
307.921.00.1	2294031	70 / 90	75 / 90	97	4	15
308.921.00.1	2294569	90 / 100	90 / 110	121	4	15
310.921.00.1	2294573	100 / 125	110 / 135	145	4	15
312.921.00.1	2294032	125	135	155	4	15

Geberit isolasjonsbandasje av PE

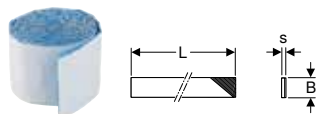

click & scan

Art. nr.	NRF nr.	s [mm]	L [m]	B [cm]
300.007.00.2	2294581	3	3,6	7

Isoleringer for strukturlydkobling og luftlydisolering

Geberit Isol Flex lydisolasjonsmatte rørtilpasset

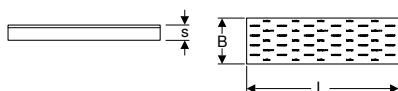

click & scan

Art. nr.	NRF nr.	DN	d, ø [mm]	s [mm]	L [m]	B [cm]
356.010.00.1	2294033	56 / 60	56 / 63	17	1,18	32
356.011.00.1	2294034	70	75	17	1,18	36
356.012.00.1	2294035	90	90	17	1,18	41
356.013.00.1	2294036	100	110	17	1,18	48
356.014.00.1	2294037	125	125 / 135	17	1,18	57

Geberit Isol Flex lydisolasjonsmatte

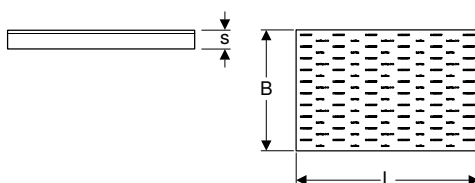

click & scan

Art. nr.	NRF nr.	s [mm]	L [m]	B [cm]
356.015.00.1	2294038	17	1,18	78

Geberit Isol Flex lydisolasjonsmatte selvklebende

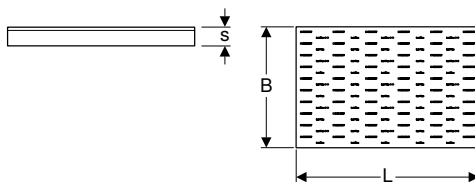

click & scan

Art. nr.	NRF nr.	s [mm]	L [m]	B [cm]
356.016.00.1	2294039	17	1,18	78





GEBERIT
GFB 90
BON-AIR

TYPE-A1-EN 12082

Bechtungsgefahr!
Nur für Wasser geeignet!
Nicht für Abwasser geeignet!

Ventilatorventiler for avløp

Ventilatorventiler	274
Energistoppeventiler	274



Ventilatorventiler

Geberit ventilatorventil GRB50 for spillvannsystemer



click & scan

Art. nr.	Farge / overflate	d, ø [mm]	G ["]	di, ø [mm]	L [cm]	B [cm]	H [cm]	h [cm]
359.900.00.1	Hvit	50	1 1/2"	32 / 40	8,3	7,4	7,3	3,2

Energistoppeventiler

Geberit energistoppeventil ERV

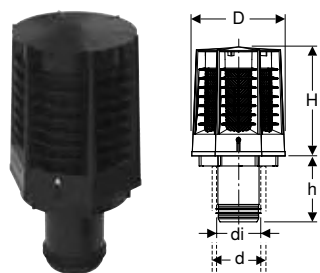

click & scan

Art. nr.	NRF nr.	Farge / overflate	DN	d, ø [mm]	di, ø [mm]	D [cm]	H [cm]	h [cm]
359.969.00.1	2293917	Svart	100	110	98-103	21,5	25,1	15,2





Verktøy

Pressenheter	280
Pressenheter kompatibilitet [1]	280
Pressenheter kompatibilitet [2]	281
Pressenheter kompatibilitet [2XL]	283
Pressenheter kompatibilitet [4]/[2]	284
Verktøy for Geberit Mapress	285
Sortimentsoversikt – Geberit Mapress kompatibilitet [1], [2], [3], [2XL] og [HCP] ...	285
Sortimentsoversikt – Geberit press-slinger	287
Presseverktøy kompatibilitet [1]	287
Presseverktøy kompatibilitet [2]	288
Presseverktøy kompatibilitet [2XL]	290
Presseverktøy kompatibilitet [3]	291
Rørbearbeidingsverktøy	291
Trykkprøvingsplugg	293
Tilbehør	293
Verktøy til Geberit FlowFit	294
Sortimentsoversikt – Geberit FlowKit-kompatibilitet [1] og [2]	294
Manuelle pressverktøy	296
Pressverktøy – kompatibilitet [1]	296
Pressverktøy – kompatibilitet [2]	297
Rørbearbeidingsverktøy	298
Trykkprøvingsplugg	300
Testmiddel	300
Pressenheter med verktøy	301
Tilbehør	301



Verktøy for Geberit Mepla	302
Sortimentsoversikt – Geberit Mepla kompatibilitet [1] og [2].	302
Håndpressverktøy	303
Presseverktøy kompatibilitet [1]	304
Presseverktøy kompatibilitet [2]	304
Rørbearbeidingsverktøy.	306
Trykkprøvingsplugg	309
Tilbehør	309
Verktøy for Geberit Silent-db20 / Geberit PE	309
Elektrosveiseverktøy	309
Buttsveiseverktøy	310
Sortimentsoversikt – Geberit buttsveiseverktøy	310
Tilbehør for buttsveiseverktøy	311
Tilbehørsoversikt – Geberit håndhøvler og elektriske høvler	311
Rørbearbeidingsverktøy	314
Tilbehør for rørbearbeidingsverktøy	317
Betjeningshjelpemidler	317
Fjernkontroller	317



Pressenheter

Pressenheter kompatibilitet [1]

Geberit ACO 103plus pressverktøy [1], i koffert



click & scan

Art. nr. NRF nr. Kompatibilitet Merkespenning / nettfrekvens Beskyttelsesklasse Inngangsstrøm Støpseltype Vekt hovedelement

Gyldig for systemet: Geberit Mapress / Geberit Mepla / Geberit FlowFit

691.017.P1.1	1083496	[1]	230 V / 50-60 Hz	III	55	CEE 7/16	6,78
--------------	---------	-----	------------------	-----	----	----------	------

Geberit ACO 103plus pressverktøy [1]



click & scan

Art. nr. NRF nr. Kompatibilitet Merkespenning / nettfrekvens Beskyttelsesklasse Inngangsstrøm Vekt hovedelement

690.017.00.1	1083497	[1]	12 V DC	III	240	1,625
--------------	---------	-----	---------	-----	-----	-------

Bestilles i tillegg

- Geberit Li-ion-batteri 12 V → s. 280
- Geberit ladeapparat 12 V → s. 280



- Passer i Geberit koffert med koffertinnsats fra 10A-I

Geberit Li-ion-batteri 12 V



click & scan

Art. nr. NRF nr. Merkespenning / nettfrekvens Batterikapasitet

690.019.00.1	1084093	12 V DC	[Ah]
--------------	---------	---------	------

690.019.00.1	1084093	12 V DC	2
--------------	---------	---------	---

Geberit ladeapparat 12 V



click & scan

Art. nr. NRF nr. Merkespenning / nettfrekvens Inngangsstrøm Støpseltype Batteriladetid

242.614.P1.1	1084061	220-240 V / 50/60 Hz	55	CEE 7/16	[min]
--------------	---------	----------------------	----	----------	-------

242.614.P1.1	1084061	220-240 V / 50/60 Hz	55	CEE 7/16	30
--------------	---------	----------------------	----	----------	----

Pressenheter kompatibilitet [2]

Geberit MFP 2 manuelt pressverktøy [2]



click & scan

Art. nr.	NRF nr.	Kompatibilitet	Vekt hovedelement
90523	1084004	[2]	5,26

Geberit ACO 203plus pressenhet [2], i koffert



click & scan

Art. nr.	NRF nr.	Kompatibilitet	Merkespenning / nettfrekvens	Beskyttelsesklasse	Inngangsstrøm	Støpseltype	Vekt hovedelement
Gyldig for systemet: Geberit Mapress / Geberit Mepla / Geberit FlowFit							
691.218.P1.2	1083498	[2]	230 V / 50-60 Hz	III	90	CEE 7/16	8,97

Tilbehør

- Geberit Li-ion-batteri 18 V → s. 281

Geberit ACO 203plus pressverktøy [2]



click & scan

Art. nr.	NRF nr.	Kompatibilitet	Merkespenning / nettfrekvens	Beskyttelsesklasse	Inngangsstrøm	Vekt hovedelement
690.512.00.2	1083499	[2]	18 V DC	III	450	3,7

Bestilles i tillegg

- Geberit Li-ion-batteri 18 V → s. 281



- Passer i Geberit koffert med koffertinnsats fra 20A-II

Geberit Li-ion-batteri 18 V



click & scan

Art. nr.	NRF nr.	Merkespenning / nettfrekvens	Batterikapasitet [Ah]
690.589.00.1	1084095	18 V DC	2
690.600.00.1	1084111	18 V DC	5



Geberit ladeapparat 12/18 V



click & scan

Art. nr.	NRF nr.	Merkespenning / nettfrekvens	Inngangsstrøm	Støpseltype	Batteriladetid [min]
690.598.P1.2	1084101	110–240 V / 50/60 Hz	90	CEE 7/16	40–75

Geberit ECO 203 pressverktøy [2], i koffert



click & scan

Art. nr.	NRF nr.	Kompatibilitet	Merkespenning / nettfrekvens	Beskyttelsesklasse	Inngangsstrøm	Støpseltype	Vekt hovedelement
Gyldig for systemet: Geberit Mapress / Geberit Mepla / Geberit FlowFit							
691.214.P2.1	1084071	[2]	230 V / 50–60 Hz	II	450	CEE 7/17	8,64

Geberit ECO 203 pressverktøy [2]



click & scan

Art. nr.	NRF nr.	Kompatibilitet	Merkespenning / nettfrekvens	Beskyttelsesklasse	Inngangsstrøm	Støpseltype	Vekt hovedelement
690.511.P2.1	1084069	[2]	230 V / 50–60 Hz	II	450	CEE 7/17	4,055



- Passer i Geberit koffert med koffertinnsats fra 20B-II

Geberit EFP 203 pressverktøy [2], i koffert



click & scan

Art. nr. NRF nr. Kompatibilitet Merkespenning / nettfrekvens Beskyttelsesklasse Inngangsstrøm Støpseltype Vekt hovedelement

Gyldig for systemet: Geberit Mapress / Geberit Mepla / Geberit FlowFit

691.113.P2.1	1084068	[2]	230 V / 50-60 Hz	II	450	CEE 7/17	8,17
--------------	---------	-----	------------------	----	-----	----------	------

Geberit EFP 203 pressverktøy [2]



click & scan

Art. nr. NRF nr. Kompatibilitet Merkespenning / nettfrekvens Beskyttelsesklasse Inngangsstrøm Støpseltype Vekt hovedelement

691.103.P2.1	1084074	[2]	230 V / 50-60 Hz	II	450	CEE 7/17	4,149
--------------	---------	-----	------------------	----	-----	----------	-------



- Passer i Geberit koffert med koffertinnsats fra 20B-II

Pressenheter kompatibilitet [2XL]

Geberit ACO 203XLplus pressverktøy [2] / [2XL], i koffert



click & scan

Art. nr. Kompatibilitet Merkespenning / nettfrekvens Beskyttelsesklasse Inngangsstrøm Støpseltype Vekt hovedelement

Gyldig for systemet: Geberit Mapress / Geberit Mepla / Geberit FlowFit

691.229.P1.2	[2] / [2XL]	230 V / 50-60 Hz	III	90	CEE 7/16	10,738
--------------	-------------	------------------	-----	----	----------	--------

Geberit ACO 203XLplus pressverktøy [2] / [2XL]



click & scan

Art. nr. NRF nr. Kompatibilitet Merkespenning / nettfrekvens Beskyttelsesklasse Inngangsstrøm Vekt hovedelement

690.514.00.2	1083502	[2] / [2XL]	18 V DC	III	450	4,559
--------------	---------	-------------	---------	-----	-----	-------

Bestilles i tillegg

- Geberit Li-ion-batteri 18 V → s. 281



- Passer i Geberit koffert med koffertinnsats fra 20D



Geberit Li-ion-batteri 18 V



click & scan

Art. nr.	NRF nr.	Merkespenning / nettfrekvens	Batterikapasitet [Ah]
690.589.00.1	1084095	18 V DC	2
690.600.00.1	1084111	18 V DC	5

Geberit ladeapparat 12/18 V



click & scan

Art. nr.	NRF nr.	Merkespenning / nettfrekvens	Inngangsstrøm	Støpseltype	Batteriladetid [min]
690.598.P1.2	1084101	110–240 V / 50/60 Hz	90	CEE 7/16	40–75

Pressenheter kompatibilitet [4]/[2]

Geberit CP700G hydraulisk verktøy i koffert









click & scan

Art. nr.	Kompatibilitet	Merkespenning / nettfrekvens	Beskyttelsesklasse	Inngangsstrøm	Støpseltype	Vekt hovedelement
691.231.P1.1	[2] / [4]	230 V / 50–60 Hz	III	200	CEE 7/16	12,5

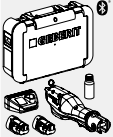
Verktøy for Geberit Mapress

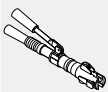

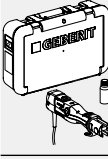
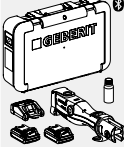



Sortimentsoversikt – Geberit Mapress kompatibilitet [1], [2], [3], [2XL] og [HCP]

Geberit Norge, Versjon: oktober 2023

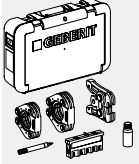
	Art. nr.	Dimensjon
Kompatibilitet [1]		
 Geberit ACO 103plus pressverktøy [1], i koffert	691.017.P1.1	
 Geberit Mapress pressbakkesett [1]		12 mm
		15 mm
		18 mm
		22 mm
		28 mm
 Geberit Mapress pressbakke [1]	690.321.00.1	12 mm
	690.322.00.1	15 mm
	690.323.00.1	18 mm
	690.324.00.1	22 mm
	690.121.00.1	12 mm
	690.122.00.1	15 mm
	690.123.00.1	18 mm
	690.124.00.1	22 mm
690.125.00.1	28 mm	
690.126.00.1	35 mm	
Kompatibilitet [2]		
 Geberit MFP 2 manuelt pressverktøy [2]	90523	
 Geberit EFP 203 pressverktøy [2], i koffert	691.113.P2.1	
 Geberit ECO 203 pressverktøy [2], i koffert	691.214.P2.1	
 Geberit ACO 203plus pressenhet [2], i koffert	691.218.P1.2	
 Geberit Mapress pressbakkesett [2]		12 mm
		15 mm
		18 mm
		22 mm
		28 mm
 Geberit Mapress pressbakke [2]	690.221.00.1	12 mm
	690.222.00.1	15 mm
	690.223.00.1	18 mm
	690.224.00.1	22 mm
	690.225.00.1	28 mm
	690.226.00.1	35 mm

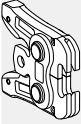
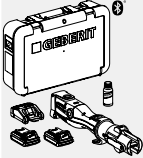
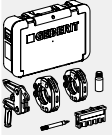
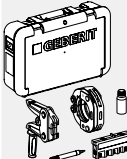

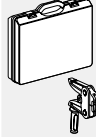
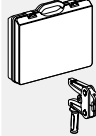
Geberit Norge, Versjon: oktober 2023

	Art. nr.	Dimensjon
 <p>Geberit Mapress press-slinger [2], i koffert</p>	691.296.00.2	42 mm 54 mm
 <p>Geberit Mapress press-slinge [2] / [3]</p>	691.181.00.1	35 mm
	691.182.00.1	42 mm
	691.183.00.1	54 mm
 <p>Geberit ZB 203A mellombakke [2]</p>	691.203.00.1	35 mm 42 mm 50 mm 54 mm 63 mm 66.7 mm 75 mm
Kompatibilitet [2XL]		
 <p>Geberit ACO 203XLplus pressverktøy [2] / [2XL], i koffert</p>	691.229.P1.2	
 <p>Geberit Mapress press-slinger [2XL], i koffert</p>	691.188.00.1	76.1 mm 88.9 mm
 <p>Geberit Mapress press-slinge [2XL], i koffert</p>	691.189.00.1	108 mm
 <p>Geberit Mapress press-slinge [2XL] / [3]</p>	90797	76.1 mm
	90798	88.9 mm
	90799	108 mm
 <p>Geberit Mapress ZB 221 mellombakke [2XL]</p>	691.186.00.1	76.1 mm 88.9 mm 108 mm
 <p>Geberit Mapress ZB 222 mellombakke [2XL]</p>	691.187.00.1	108 mm
Kompatibilitet [4]		
 <p>Geberit CP700G hydraulisk verktøy i koffert</p>	691.231.P1.1	

Sortimentsoversikt – Geberit press-slinger

Geberit Norge, Versjon: oktober 2023

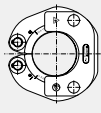
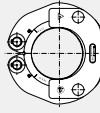
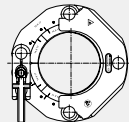
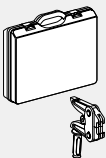
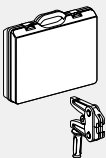
	Press-slinge ny – d76.1	Press-slinge ny – d88.9	Press-slinge ny – d108
			
	90797	90798	90799
Kompatibilitet [2XL] – ny			
691.186.00.1 Geberit Mapress ZB 221 mellombakke [2XL] 	✓	✓	✓
691.187.00.1 Geberit Mapress ZB 222 mellombakke [2XL] 			✓

✓ Kompatibel

Presseverktøy kompatibilitet [1]

Geberit Mapress pressbakkesett [1]

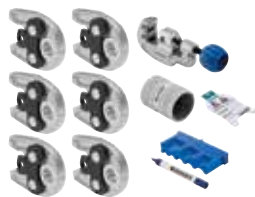

click & scan

Art. nr.	NRF nr.	Kompatibilitet	d, ø [mm]
690.190.00.1	1083479	[1]	12 / 15 / 18 / 22 / 28 / 35



- Passer i Geberit koffert med koffertinnsats fra 10A-IV

Geberit Mapress pressbakke [1]



click & scan

Art. nr.	NRF nr.	Kompatibilitet	d, ø [mm]
690.121.00.1	1083481	[1]	12
690.122.00.1	1083482	[1]	15
690.123.00.1	1083483	[1]	18
690.124.00.1	1083484	[1]	22
690.125.00.1	1083485	[1]	28
690.126.00.1	1083486	[1]	35

Tilbehør

- Geberit ACO 103plus pressverktøy [1], i koffert → s. 280



- Passer i Geberit koffert med koffertinnsats fra 10A-IV



Geberit Mapress pressbakke [1]



click & scan

Art. nr.	Kompatibilitet	d, ø [mm]
690.321.00.1	[1]	12
690.322.00.1	[1]	15
690.323.00.1	[1]	18
690.324.00.1	[1]	22

Presseverktøy kompatibilitet [2]

Geberit Mapress pressbakkesett [2]

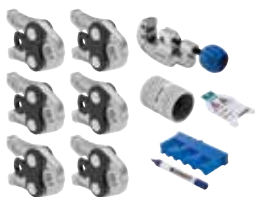

click & scan

Art. nr.	NRF nr.	Kompatibilitet	d, ø [mm]
690.230.00.1	1083487	[2]	12 / 15 / 18 / 22 / 28 / 35

Tilbehør

- Geberit koffert for pressbakker [2], [3], med koffertinnsats 10C-II → s. 289



- Passer i Geberit koffert med koffertinnsats fra 10C-II, 20A-V, 20B-IV, 20D-II
- Egner seg ikke for Geberit pressverktøy PWH 40

Geberit Mapress pressbakke [2]



click & scan

Art. nr.	NRF nr.	Kompatibilitet	d, ø [mm]
690.221.00.1	1083488	[2]	12
690.222.00.1	1083489	[2]	15
690.223.00.1	1083491	[2]	18
690.224.00.1	1083492	[2]	22
690.225.00.1	1083493	[2]	28
690.226.00.1	1083494	[2]	35

Tilbehør

- Geberit koffert for pressbakker [2], [3], med koffertinnsats 10C-II → s. 289



- Passer i Geberit koffert med koffertinnsats fra 10C-II, 20A-V, 20B-IV, 20D-II
- Egner seg ikke for Geberit pressverktøy PWH 40

Geberit koffert for pressbakker [2], [3], med koffertinnsats 10C-II



click & scan

Art. nr.	NRF nr.	Typenummer	B [cm]	H [cm]	T [cm]
691.137.00.1	1084046	10C-II	52,4	38,3	17,4

Geberit Mapress press-slinger [2], i koffert



click & scan

Art. nr.	NRF nr.	Kompatibilitet	d, ø [mm]
691.296.00.2	1084057	[2]	42 / 54



- Egner seg ikke for Geberit presseverktøy PWH 40

Geberit Mapress press-slinge [2] / [3]



click & scan

Art. nr.	Kompatibilitet	d, ø [mm]
691.181.00.1	[2] / [3]	35
691.182.00.1	[2] / [3]	42
691.183.00.1	[2] / [3]	54

Bestilles i tillegg

- Geberit ZB 203A mellombakke [2] → s. 289



- Egner seg ikke for Geberit presseverktøy PWH 40

Geberit ZB 203A mellombakke [2]



click & scan

Art. nr.	NRF nr.	Kompatibilitet	d, ø [mm]
691.203.00.1	1083495	[2]	35 / 42 / 50 / 54 / 63 / 66,7 / 75



- Egner seg ikke for Geberit presseverktøy PWH 40



Presseverktøy kompatibilitet [2XL]

Geberit Mapress press-slinger [2XL], i koffert



click & scan

Art. nr.	NRF nr.	Kompatibilitet	d, ø [mm]
691.188.00.1	1084098	[2XL]	76,1 / 88,9

Geberit Mapress press-slinge [2XL], i koffert



click & scan

Art. nr.	NRF nr.	Kompatibilitet	d, ø [mm]
691.189.00.1	1084099	[2XL]	108

Bestilles i tillegg

- Geberit Mapress ZB 221 mellombakke [2XL] → s. 290

Geberit Mapress press-slinge [2XL] / [3]



click & scan

Art. nr.	NRF nr.	Kompatibilitet	d, ø [mm]
90797	1084075	[2XL] / [3]	76,1
90798	1084076	[2XL] / [3]	88,9
90799	1084077	[2XL] / [3]	108

Bestilles i tillegg

- Geberit Mapress ZB 221 mellombakke [2XL] → s. 290
- Geberit Mapress ZB 222 mellombakke [2XL] → s. 291

Geberit Mapress ZB 221 mellombakke [2XL]



click & scan

Art. nr.	NRF nr.	Kompatibilitet	d, ø [mm]
691.186.00.1	1084096	[2XL]	76,1 / 88,9 / 108

Geberit Mapress ZB 222 mellombakke [2XL]



click & scan

Art. nr.	NRF nr.	Kompatibilitet	d, ø [mm]
691.187.00.1	1084097	[2XL]	108

Presseverktøy kompatibilitet [3]

Geberit Mapress press-slinge [2] / [3]



click & scan

Art. nr.	Kompatibilitet	d, ø [mm]
691.181.00.1	[2] / [3]	35
691.182.00.1	[2] / [3]	42
691.183.00.1	[2] / [3]	54

Bestilles i tillegg

- Geberit ZB 203A mellombakke [2] → s. 289



- Egner seg ikke for Geberit presseverktøy PWH 40

Geberit Mapress press-slinge [2XL] / [3]



click & scan

Art. nr.	NRF nr.	Kompatibilitet	d, ø [mm]
90797	1084075	[2XL] / [3]	76,1
90798	1084076	[2XL] / [3]	88,9
90799	1084077	[2XL] / [3]	108

Bestilles i tillegg

- Geberit Mapress ZB 221 mellombakke [2XL] → s. 290
- Geberit Mapress ZB 222 mellombakke [2XL] → s. 291

Rørbearbeidingsverktøy

Geberit Mapress rørkutter R



click & scan

Art. nr.	NRF nr.	d, ø [mm]	Modell
91087	1083472	12-35	35S
91088	1083008	12-54	65S



Kappskivesett for Geberit Mapress rørkutter R



click & scan

Art. nr.	NRF nr.	d, ø [mm]
91092	1083014	12-54

Geberit Mapress avgrader



click & scan

Art. nr.	NRF nr.	d, ø [mm]
90357		12-35
90363	1084005	12-54

Geberit Mapress avmantlingsverktøy



click & scan

Art. nr.	d, ø [mm]
90371	12
90372	15
90373	18
90374	22
90375	28

Geberit Mapress avmantlingsverktøy



click & scan

Art. nr.	d, ø [mm]
90376	35 / 42 / 54

Geberit Mapress merkemal med merkepenn



click & scan

Art. nr.	NRF nr.	d, ø [mm]
90351	1084092	12-108

Trykkprøvingsplugg

Geberit Mapress trykkprøvingsplugg for fittings

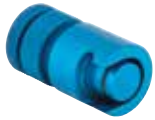

[click & scan](#)

Art. nr.	NRF nr.	d, ø [mm]
90922	1083452	15
90923	1083453	18
90924	1083454	22
90925	1083455	28
90926	1083456	35
90927	1083457	42
90928	1083458	54

Tilbehør

Geberit lekkasjesøkingsspray



[click & scan](#)









Art. nr.	Innhold [ml]
690.942.00.1	400







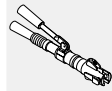

Verktøy til Geberit FlowFit

Sortimentsoversikt – Geberit FlowKit-kompatibilitet [1] og [2]

Geberit Norge, Versjon: oktober 2023

		Art. nr.	Dimensjon
Manuell presstang			
	Geberit FlowFit håndpresseverktøy i koffert	691.031.00.1	16 mm 20 mm 25 mm 32 mm 40 mm
	Geberit FlowFit manuell presstang	691.030.00.1	16 mm 20 mm 25 mm 32 mm 40 mm
Kompatibilitet [1]			
	Geberit FlowFit pressbakke i koffert	655.081.00.1	16 mm 20 mm 25 mm 32 mm 40 mm
	Geberit FlowFit koffert utstyrt med verktøy [1]	655.078.00.1	16 mm 20 mm 25 mm 32 mm 40 mm
	Geberit FlowFit sett pressbakke [1]	691.035.00.1	16 mm 20 mm 25 mm 32 mm 40 mm
	Geberit FlowFit pressbakke [1]	691.032.00.1	16 mm 20 mm 25 mm 32 mm 40 mm
Kompatibilitet [2]			
	Geberit MFP 2 manuell pressverktøy [2]	90523	
	Geberit FlowFit pressbakke i koffert	655.082.00.1	16 mm 20 mm 25 mm 32 mm 40 mm
		655.083.00.1	16 mm 20 mm 25 mm 32 mm 40 mm 50 mm 63 mm 75 mm

Geberit Norge, Versjon: oktober 2023

		Art. nr.	Dimensjon
	Geberit FlowFit koffert utstyrt med verktøy [2]	655.084.00.1	16 mm
			20 mm
	Geberit FlowFit koffert utstyrt med verktøy [2]	655.079.00.1	25 mm
			32 mm
	Geberit FlowFit sett pressbakke [2]	691.036.00.1	40 mm
			16 mm
	Geberit FlowFit sett pressbakke [2]	691.037.00.1	20 mm
			25 mm
	Geberit FlowFit pressbakke [2]	691.033.00.1	32 mm
			40 mm
	Geberit FlowFit pressbakke [2]	691.034.00.1	50 mm
			63 mm
			75 mm



Manuelle pressverktøy

Geberit FlowFit håndpresseverktøy i koffert



click & scan

Art. nr.	NRF nr.	d, ø [mm]
691.031.00.1	2473762	16 / 20 / 25 / 32 / 40

Tilbehør

- Geberit FlowFit etterfyllingssett til PowerTest → s. 300

Geberit FlowFit manuell presstang



click & scan

Art. nr.	NRF nr.	d, ø [mm]
691.030.00.1	2473763	16 / 20 / 25 / 32 / 40

Tilbehør

- Koffert for håndpresseverktøy → s. 301
- Geberit FlowFit PowerTest i koffert → s. 300

Pressverktøy – kompatibilitet [1]

Geberit FlowFit koffert utstyrt med verktøy [1]



click & scan

Art. nr.	NRF nr.	Kompatibilitet	d, ø [mm]	B [cm]	H [cm]	T [cm]
655.078.00.1	2473794	[1]	16 / 20 / 25 / 32 / 40	50,6	34,9	16

Geberit FlowFit sett pressbakke [1]



click & scan

Art. nr.	NRF nr.	Kompatibilitet	d, ø [mm]
691.035.00.1	2473764	[1]	16 / 20 / 25 / 32 / 40

Tilbehør

- Geberit ACO 103plus pressverktøy [1] → s. 280



- Passer i Geberit koffert med koffertinnsats 10-O
- Art. nr.: 691.156.00.1, 691.153.00.1
- Passer i Geberit koffert med koffertinnsats 10-P
- Art. no.: 691.161.00.1, 655.078.00.1

Geberit FlowFit pressbakke [1]



click & scan

Art. nr.	NRF nr.	Kompatibilitet	d, ø [mm]
691.032.00.1	2473765	[1]	16 / 20 / 25 / 32 / 40

Tilbehør

- Geberit FlowFit oppsamlingsenhet for pressindikatorer → s. 301
- Geberit FlowFit PowerTest i koffert → s. 300
- Geberit ACO 103plus pressverktøy [1] → s. 280



- Passer i Geberit koffert med koffertinnsats 10-O
- Art. nr.: 691.156.00.1, 691.153.00.1
- Passer i Geberit koffert med koffertinnsats 10-P
- Art. no.: 691.161.00.1, 655.078.00.1

Pressverktøy – kompatibilitet [2]

Geberit FlowFit koffert utstyrt med verktøy [2]



click & scan

Art. nr.	NRF nr.	Kompatibilitet	d, ø [mm]	B [cm]	H [cm]	T [cm]
655.079.00.1	2473793	[2]	16 / 20 / 25 / 32 / 40 / 50 / 63 / 75	50,6	34,9	16
655.084.00.1	2472057	[2]	16 / 20 / 25 / 32 / 40	50,6	34,9	16

Geberit FlowFit sett pressbakke [2]



click & scan

Art. nr.	NRF nr.	Kompatibilitet	d, ø [mm]
691.036.00.1	2473766	[2]	16 / 20 / 25 / 32 / 40
691.037.00.1	2473767	[2]	16 / 20 / 25 / 32 / 40 / 50 / 63 / 75

Tilbehør

- Geberit ACO 203plus pressverktøy [2] → s. 281
- Geberit ECO 203 pressverktøy [2] → s. 282
- Geberit EFP 203 pressverktøy [2] → s. 283



- Passer i Geberit koffert med koffertinnsats 10-P
- Art. no.: 691.161.00.1, 655.079.00.1
- Passer i Geberit koffert med koffertinnsats 20-I og 20-J
- Art. nr.: 691.154.00.1, 691.155.00.1, 691.157.00.1, 691.158.00.1



Geberit FlowFit pressbakke [2]



click & scan

Art. nr.	NRF nr.	Kompatibilitet	d, ø [mm]
691.033.00.1	2473768	[2]	16 / 20 / 25 / 32 / 40
691.034.00.1	2473769	[2]	50 / 63 / 75

Tilbehør

- Geberit ACO 203plus pressverktøy [2] → s. 281
- Geberit ECO 203 pressverktøy [2] → s. 282
- Geberit EFP 203 pressverktøy [2] → s. 283



- Passer i Geberit koffert med koffertinnsats 10-P
- Art. no.: 691.161.00.1, 655.079.00.1
- Passer i Geberit koffert med koffertinnsats 20-I og 20-J
- Art. nr.: 691.154.00.1, 691.155.00.1, 691.157.00.1, 691.158.00.1

Rørbearbeidingsverktøy

Geberit saks



click & scan

Art. nr.	NRF nr.	d, ø [mm]
650.921.00.2	2472056	14–26

Geberit sett skjærehjul for rørkutter



click & scan

Art. nr.	d, ø [mm]
690.936.00.1	14–26

Geberit rørkutter ML



click & scan

Art. nr.	NRF nr.	d, ø [mm]
690.112.00.1	2472782	16–50
690.115.00.1	2472783	32–75

Geberit kappeskivesett for rørkutter ML



click & scan

Art. nr.	NRF nr.	d, ø [mm]
690.111.00.1	2472786	16-75

Geberit FlowFit kalibreringsverktøy



click & scan

Art. nr.	NRF nr.	d, ø [mm]	L [cm]
690.300.00.1	2473771	16 / 20 / 25 / 32 / 40	15,8
690.301.00.1	2473772	50 / 63 / 75	15,3

Geberit markeringspenn med justerbar fettstift



click & scan

Art. nr.	Farge / overflate
690.102.00.1	Gul

Tilbehør

- Geberit reserve fettstift for markeringspenn med justerbar fettstift → s. 187

Geberit reserve fettstift for markeringspenn med justerbar fettstift



click & scan

Art. nr.	Farge / overflate
690.103.00.1	Gul

Geberit håndbøyeverktøy hydraulisk, i koffert



click & scan

Art. nr.	NRF nr.	d, ø [mm]
690.412.00.3	2472853	16 / 20 / 26 / 32



Verktøy

Verktøy til Geberit FlowFit
Trykkprøvingsplugg

Geberit utvendig spiralfjær ML

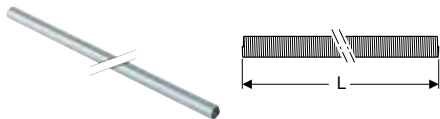

click & scan

Art. nr.	d, ø [mm]	L [cm]
690.912.00.1	16	50
690.913.00.1	20	50

Trykkprøvingsplugg

Geberit FlowFit trykkprøvingsplugg til rørende

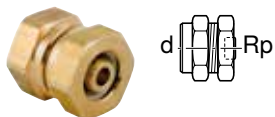

click & scan

Art. nr.	NRF nr.	d, ø [mm]	Rp ["]
653.940.26.1	2473773	16	1/2"
654.940.26.1	2473774	20	1/2"
655.940.26.1	2473775	25	1/2"
656.940.26.1	2473776	32	1/2"
657.940.26.1	2473777	40	1/2"
658.940.26.1	2473778	50	1/2"
659.940.26.1	2473779	63	1/2"

Testmiddel

Geberit FlowFit etterfyllingssett til PowerTest

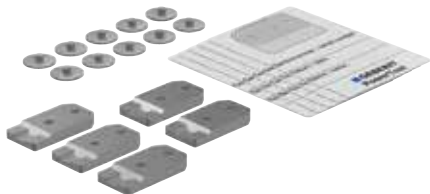

click & scan

Art. nr.	NRF nr.	d, ø [mm]
690.917.00.1	2473783	16 / 20 / 25 / 32 / 40
690.918.00.1	2473784	50 / 63 / 75

Geberit FlowFit PowerTest i koffert



click & scan

Art. nr.	NRF nr.	d, ø [mm]
690.915.00.1	2473781	16 / 20 / 25 / 32 / 40
690.916.00.1	2473782	50 / 63 / 75

Tilbehør

- Geberit FlowFit etterfyllingssett til PowerTest → s. 300

Pressenheter med verktøy

ACO 103plus pressenhet med Geberit FlowFit-verktøy [1]



click & scan

Art. nr.	NRF nr.	Kompatibilitet	d, ø [mm]	Merkespenning / nettfrekvens	Inngangsstrøm	Støpseltype
655.104.00.1	1084003	[1]	16 / 20 / 25 / 32 / 40	230 V / 50/60 Hz	55	CEE 7/16

Tilbehør

Koffert for håndpresseverktøy



click & scan

Art. nr.	NRF nr.	Typenummer	d, ø [mm]	B [cm]	H [cm]	T [cm]
691.152.00.1	2473785	10-N	16 / 20 / 26	50,6	34,9	16

Geberit FlowFit pressbakke i koffert



click & scan

Art. nr.	NRF nr.	Kompatibilitet	d, ø [mm]
655.081.00.1	2473789	[1]	16 / 20 / 25 / 32 / 40
655.082.00.1	2473791	[2]	16 / 20 / 25 / 32 / 40
655.083.00.1	2473792	[2]	16 / 20 / 25 / 32 / 40 / 50 / 63 / 75

Geberit FlowFit oppsamlingsenhet for pressindikatorer



click & scan

Art. nr.	d, ø [mm]
690.940.00.1	16 / 20 / 25 / 32 / 40
690.941.00.1	50 / 63 / 75



Geberit lekkasjesøkingspray











click & scan

Art. nr.	Innhold [ml]
690.942.00.1	400

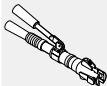



Verktøy for Geberit Mepla

Sortimentsoversikt – Geberit Mepla kompatibilitet [1] og [2]

Geberit Norge, Versjon: oktober 2023

	Art. nr.	Dimensjon
Kompatibilitet [1]		
 Geberit ACO 103plus pressverktøy [1], i koffert	691.017.P1.1	
 Geberit Mepla pressbakkesett [1]	690.182.00.1	16 mm 20 mm 26 mm 32 mm 40 mm
 Geberit Mepla pressbakke [1]	690.140.00.1	16 mm
	690.141.00.1	20 mm
	690.142.00.1	26 mm
	690.143.00.1	32 mm
	690.144.00.1	40 mm
Kompatibilitet [2]		
 Geberit MFP 2 manuelt pressverktøy [2]	90523	
 Geberit EFP 203 pressverktøy [2], i koffert	691.113.P2.1	
 Geberit ECO 203 pressverktøy [2], i koffert	691.214.P2.1	
 Geberit ACO 203plus pressenhet [2], i koffert	691.218.P1.2	
 Geberit Mepla pressbakkesett [2]	690.253.00.1	16 mm 20 mm 26 mm 32 mm 40 mm 50 mm
 Geberit Mepla pressbakke [2]	690.240.00.1	16 mm
	690.241.00.1	20 mm
	690.242.00.1	26 mm
	690.243.00.1	32 mm
	690.244.00.1	40 mm
	690.245.00.1	50 mm

Geberit Norge, Versjon: oktober 2023

	Art. nr.	Dimensjon
 Geberit Mepla press-slinge [2], i koffert	690.467.00.2	63 mm
 Geberit Mepla press-slinge [2]	691.170.00.1	63 mm
 Geberit Mepla press-slinge [2]	691.171.00.1	75 mm
 Geberit ZB 203A mellombakke [2]	691.203.00.1	35 mm 42 mm 50 mm 54 mm 63 mm 66.7 mm 75 mm

Håndpressverktøy

Geberit Mepla håndpresseverktøy i koffert



click & scan

Art. nr.	d, ø [mm]
690.486.00.4	16 / 20 / 26

Geberit Mepla manuell presstang



click & scan

Art. nr.	NRF nr.	d, ø [mm]
690.475.00.1		16
690.476.00.1	2472845	20
690.474.00.1		26



Presseverktøy kompatibilitet [1]

Geberit Mepla pressbakkesett [1]



click & scan

Art. nr.	NRF nr.	Kompatibilitet	d, ø [mm]
690.182.00.1	1083473	[1]	16 / 20 / 26 / 32 / 40

Tilbehør

- Geberit ACO 103plus pressverktøy [1] → s. 280



- Passer i Geberit koffert med koffertinnsats fra 10A-III

Geberit Mepla pressbakke [1]



click & scan

Art. nr.	NRF nr.	Kompatibilitet	d, ø [mm]
690.140.00.1	1083474	[1]	16
690.141.00.1	1083475	[1]	20
690.142.00.1	1083476	[1]	26
690.143.00.1	1083477	[1]	32
690.144.00.1	1083478	[1]	40

Tilbehør

- Geberit ACO 103plus pressverktøy [1] → s. 280



- Passer i Geberit koffert med koffertinnsats fra 10A-III

Presseverktøy kompatibilitet [2]

Geberit Mepla pressbakkesett [2]



click & scan

Art. nr.	NRF nr.	Kompatibilitet	d, ø [mm]
690.253.00.1	2472612	[2]	16 / 20 / 26 / 32 / 40 / 50

Tilbehør

- Geberit koffert for pressbakker [2], [3], med koffertinnsats 10C-II → s. 289



- Passer i Geberit koffert med koffertinnsats fra 10C-I, 20A-IV, 20B-III, 20D-I
- Egner seg ikke for Geberit pressverktøy PWH 40

Geberit Mepla pressbakke [2]



click & scan

Art. nr.	NRF nr.	Kompatibilitet	d, ø [mm]
690.240.00.1	2472605	[2]	16
690.241.00.1	2472606	[2]	20
690.242.00.1	2472607	[2]	26
690.243.00.1	2472608	[2]	32
690.244.00.1	2472609	[2]	40
690.245.00.1	2472611	[2]	50

Tilbehør

- Geberit koffert for pressbakker [2], [3], med koffertinnsats 10C-II → s. 289



- Passer i Geberit koffert med koffertinnsats fra 10C-I, 20A-IV, 20B-III, 20D-I
- Egner seg ikke for Geberit presseverktøy PWH 40

Geberit koffert for pressbakker [2], [3], med koffertinnsats 10C-II



click & scan

Art. nr.	NRF nr.	Typenummer	B [cm]	H [cm]	T [cm]
691.137.00.1	1084046	10C-II	52,4	38,3	17,4

Geberit Mepla press-slinge [2], i koffert



click & scan

Art. nr.	NRF nr.	Kompatibilitet	d, ø [mm]
690.467.00.2	1084063	[2]	63



- Egner seg ikke for Geberit presseverktøy PWH 40



Geberit Mepla press-slinge [2]



click & scan

Art. nr.	NRF nr.	Kompatibilitet	d, ø [mm]
691.170.00.1		[2]	63
691.171.00.1	1084064	[2]	75

Bestilles i tillegg

- Geberit ZB 203A mellombakke [2] → s. 289



- Passer i Geberit koffert med koffertinnsats fra 10D-I
- Egner seg ikke for Geberit pressverktøy PWH 40

Geberit ZB 203A mellombakke [2]



click & scan

Art. nr.	NRF nr.	Kompatibilitet	d, ø [mm]
691.203.00.1	1083495	[2]	35 / 42 / 50 / 54 / 63 / 66,7 / 75



- Egner seg ikke for Geberit pressverktøy PWH 40

Rørbearbeidingsverktøy

Geberit Mepla saks



click & scan

Art. nr.	NRF nr.	d, ø [mm]
690.134.00.1	2472847	16 / 20 / 26

Geberit sett skjærehjul for rørkutter



click & scan

Art. nr.	d, ø [mm]
690.936.00.1	14-26

Geberit rørkutter ML



click & scan

Art. nr.	NRF nr.	d, ø [mm]
690.112.00.1	2472782	16-50
690.115.00.1	2472783	32-75

Geberit kappeskivesett for rørkutter ML



click & scan

Art. nr.	NRF nr.	d, ø [mm]
690.111.00.1	2472786	16-75

Geberit Mepla avgrader og kalibreringsverktøy



click & scan

Art. nr.	NRF nr.	d, ø [mm]
690.212.00.1		16 / 20 / 26
690.211.00.1	2472788	16 / 20 / 26 / 32 / 40 / 50

Geberit avgrader



click & scan

Art. nr.	NRF nr.	d, ø [mm]
690.214.00.1	2472791	63 / 75

Geberit Mepla avgrader- og kalibreringsoppsatser, i koffert



click & scan

Art. nr.	d, ø [mm]
690.920.00.1	16 / 20 / 26 / 32



Geberit Mepla avgrader- og kalibreringsoppsats



click & scan

Art. nr.	d, ø [mm]
690.921.00.1	16
690.922.00.1	20
690.923.00.1	26
690.924.00.1	32
690.925.00.1	40
690.926.00.1	50
690.927.00.1	63

Geberit markeringspenn med justerbar fettstift



click & scan

Art. nr.	Farge / overflate
690.102.00.1	Gul

Tilbehør

- Geberit reserve fettstift for markeringspenn med justerbar fettstift → s. 187

Geberit reserve fettstift for markeringspenn med justerbar fettstift



click & scan

Art. nr.	Farge / overflate
690.103.00.1	Gul

Geberit håndbøyevektøyt hydraulisk, i koffert



click & scan

Art. nr.	NRF nr.	d, ø [mm]
690.412.00.3	2472853	16 / 20 / 26 / 32

Geberit utvendig spiralfjær ML

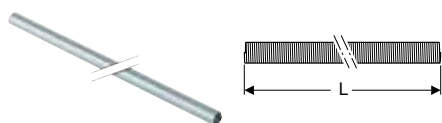

click & scan

Art. nr.	d, ø [mm]	L [cm]
690.912.00.1	16	50
690.913.00.1	20	50

Trykkprøvingsplugg

Geberit Mepla trykkprøvingsplugg for rørende

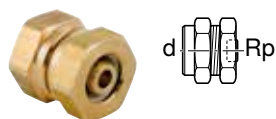

click & scan

Art. nr.	d, ø [mm]	Rp ["]
601.485.00.1	16	1/2"
602.485.00.1	20	1/2"
603.485.00.1	26	1/2"
604.485.00.1	32	1/2"
605.485.00.1	40	1/2"
606.485.00.1	50	1/2"
607.485.00.1	63	1/2"

Tilbehør

Geberit lekkasjesøkingsspray



click & scan

Art. nr.	Innhold [ml]
690.942.00.1	400

Verktøy for Geberit Silent-db20 / Geberit PE

Elektrosveiseverktøy

Geberit ESG 3 sveiseapparat 230 V



click & scan

Art. nr.	NRF nr.	Beskyttelsesklasse	Inngangsstrøm	Støpseltype	Vekt hovedelement
359.911.P0.1	2296151	I	≤ 1085	CEE 7/7	6,51

Geberit ESG Light sveiseapparat 230 V



click & scan









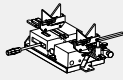
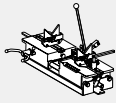

Art. nr.	NRF nr.	Beskyttelsesklasse	Inngangsstrøm	Støpseltype	Vekt hovedelement
359.910.P0.1	1083504	II	1120	CEE 7/7	2

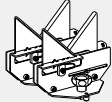

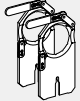
Buttsveiseverktøy

Sortimentsoversikt – Geberit buttsveiseverktøy

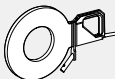
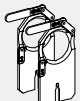
Geberit Norge, Versjon: oktober 2023

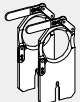
		Geberit Media sveisemaskin		Geberit Universal sveisemaskin	
		359.662.00.1		356.200.00.1	
Inkludert i leveranseomfanget					
359.778.00.1 Geberit sveisespeilstøtte for sveisemaskiner Media og Universal for sveisespeil KSS-160 / KSS-200		✓		✓	
357.800.00.1 Geberit settrørstøtter d50-160, for media og universelle sveisemaskiner		✓		✓	
359.641.P0.2 Geberit KSS-160 sveisespeil 230 V					
359.814.00.1 Geberit sett spenningsplater					
Verktøy som må bestilles separat (utvalg)					
Geberit elektrisk høvel d40-160, 230 V	HSS		359.046.xx.1		359.046.xx.1
Geberit elektrisk høvel d40-200, 230 V	HSS		-		359.082.xx.1
Geberit KSS-160 sveisespeil 230 V			359.641.xx.2		359.641.xx.2
Geberit KSS-200 sveisespeil 230 V			-		359.665.xx.2
Geberit KSS-315 sveisespeil 230 V			-		359.675.xx.2
Geberit sett spenningsplater			359.8xx.00.1		359.8xx.00.1
Geberit sett basisbakker for spenningsplate d110			359.05x.00.1		359.05x.00.1
Geberit sett spenningsplater			-		359.884.00.1

Geberit Media sveisemaskin

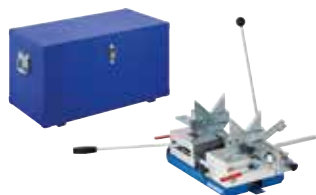

click & scan

Art. nr.	NRF nr.	d, ø [mm]	L [cm]	B [cm]	H [cm]	Vekt hovedelement
359.662.00.1	9816703	40-160	84	41	43	25,2

Geberit Universal sveisemaskin



click & scan

Art. nr.	NRF nr.	d, ø [mm]	L [cm]	B [cm]	H [cm]	Vekt hovedelement
356.200.00.1	9816701	40-315	77	43	43,5	77,497

Bestilles i tillegg

- Sveisespeil
- Sveisetilbehør ø 200-315 mm
- Spenningsplater
- Hånd- eller elektrisk høvel

Tilbehør for buttsveiseverktøy

Tilbehørsversikt – Geberit håndhøvler og elektriske høvler

Geberit Norge, Versjon: oktober 2023

	Geberit elektrisk høvel d40-160, 230 V	Geberit elektrisk høvel d40-200, 230 V
Mærkespenning	230 V AC	
Dimensjon	d40-160	d40-200
Hurtigstål ¹⁾	359.046.P2.1	359.082.P2.1
	359.046.P3.1	359.082.P3.1
	359.046.P5.1	359.082.P5.1
	359.046.P6.1	359.082.P6.1
	359.046.P7.1	359.082.P7.1
	359.046.Q4.1	359.082.Q4.1
Hardmetall ²⁾	359.046.P9.1	359.082.P9.1
Tilbehør		
Blad hurtigstål¹⁾		
358.759.00.1	1 x	-
358.760.00.1		
358.759.00.1		
358.760.00.1	-	1 x
357.600.00.1		
357.599.00.1		
357.751.00.1	-	-
Blad hardmetall³⁾		
240.474.00.1	1 x	2 x

¹⁾ For Geberit PE

²⁾ For Geberit PE og Geberit Silent-db20

³⁾ For Geberit PE og Geberit Silent-db20, sett à to stk.



Geberit KSS-160 sveisespeil 230 V

click & scan

Art. nr.	d, ø [mm]	Inngangsstrøm	Støpseltype	Vekt hovedelement
359.641.P0.2	40-160	800	CEE 7/7	2,944

Geberit KSS-200 sveisespeil 230 V

click & scan

Art. nr.	d1, ø [mm]	Inngangsstrøm	Støpseltype	Vekt hovedelement
359.665.P0.2	40-200	1300	CEE 7/7	4,5

Geberit KSS-315 sveisespeil 230 V

click & scan

Art. nr.	d, ø [mm]	Inngangsstrøm	Støpseltype	Vekt hovedelement
359.675.P0.2	200-315	1300	CEE 7/7	5,348

**Geberit sveisespeilstøtte for sveisemaskiner Media og Universal for sveisespeil
KSS-160 / KSS-200**

click & scan

Art. nr.
359.778.00.1

Geberit elektrisk høvel d40-160, 230 V

click & scan

Art. nr.	d, ø [mm]	Inngangsstrøm	Støpseltype	Vekt hovedelement
359.046.P2.1	40-160	750	CEE 7/17	5,894

Tilbehør

- Geberit høvelblad av hurtigstål, for elektrisk høvel d40-160 og elektrisk høvel d40-200 → s. 313

Geberit elektrisk høvel d40–200, 230 V



click & scan

Art. nr.	d, ø [mm]	Inngangsstrøm	Støpseltype	Vekt hovedelement
359.082.P2.1	40–200	750	CEE 7/17	6,303

Tilbehør

- Geberit høvelblad av hurtigstål, for elektrisk høvel d40–160 og elektrisk høvel d40–200 → s. 313

Geberit høvelblad av hurtigstål, for elektrisk høvel d40–160 og elektrisk høvel d40–200



click & scan

Art. nr.	NRF nr.	d, ø [mm]	Blad
357.599.00.1		200	Høyre, slipt
357.600.00.1	9816782	200	Venstre, slipt
358.759.00.1	9816777	40–200	Venstre
358.760.00.1	9816776	40–200	Høyre

Bestilles i tillegg

- Kontraskruer M3 x 6–8,8 forsinket (vanlig handelsvare)

Geberit sett basisbakker for spenningsplate d110



click & scan

Art. nr.	d, ø [mm]
359.052.00.1	50 / 110
359.053.00.1	56 / 110
359.054.00.1	63 / 110
359.056.00.1	75 / 110
359.057.00.1	90 / 110

Geberit sett spenningsplater



click & scan

Art. nr.	NRF nr.	DN	d, ø [mm]
359.817.00.1	9816721	40	40
359.818.00.1	9816722	50	50
359.811.00.1		56	56
359.809.00.1	9816723	60	63
359.812.00.1	9816724	70	75
359.813.00.1	9816725	90	90
359.814.00.1	9816726	100	110
359.819.00.1	9816727	125	125
359.822.00.1		125	135
359.816.00.1	9816728	150	160



Geberit sett spenningsplater d200

click & scan

Art. nr.	NRF nr.	DN	d, ø [mm]
359.884.00.1	9816729	200	200

Geberit sett rørstøtter d50-160, for media og universelle sveisemaskiner

click & scan

Art. nr.	d, ø [mm]
357.800.00.1	50-160

Rørbearbeidingsverktøy**Geberit rørkutter for plastrør**

click & scan

Art. nr.	NRF nr.	d, ø [mm]
358.503.00.1	1084082	48-116
358.504.00.1		100-168

Tilbehør

- Geberit kappskivesett forl rørkutter for plastrør → s. 314

Geberit kappskivesett forl rørkutter for plastrør

click & scan

Art. nr.	d, ø [mm]
242.828.00.1	48-168

Geberit rørkutter for plastrør

click & scan

Art. nr.	d, ø [mm]
359.860.00.1	200-315

Geberit håndskraper



click & scan

Art. nr.
 356.118.00.1

Geberit håndskraper i koffert



click & scan

Art. nr.	d, ø [mm]
359.912.00.1	63-160

Geberit avgrader i koffert



click & scan

Art. nr.	d, ø [mm]
359.915.00.1	110

Geberit sett avgrader i koffert



click & scan

Art. nr.	NRF nr.	d, ø [mm]
359.916.00.1	1084083	56 / 63 / 75 / 90 / 110

Geberit sett avgrader i koffert



click & scan

Art. nr.	NRF nr.	d, ø [mm]
359.917.00.1	1084084	56 / 75 / 90 / 110



Geberit avgrader

[click & scan](#)

Art. nr.	NRF nr.	DN	d, ø [mm]
359.922.00.1	1084085	56	56
359.923.00.1	1084086	60	63
359.924.00.1	1084087	70	75
359.925.00.1	1084088	90	90
359.926.00.1	1084089	100	110

Tilbehør

- Geberit koffert for sett avgrader → s. 317

Geberit avgradeverktøy

[click & scan](#)

Art. nr.	NRF nr.	d, ø [mm]
358.501.00.1	1084081	32-160

Geberit avgraderkniv

[click & scan](#)

Art. nr.	NRF nr.
359.720.00.1	9816898

Geberit håndsag

[click & scan](#)

Art. nr.	d, ø [mm]
359.832.00.1	32-160

Tilbehør

- Geberit sagblad for håndsag → s. 316

Geberit sagblad for håndsag

[click & scan](#)

Art. nr.	NRF nr.
359.844.00.1	9816884

Geberit PE reparasjonsverktøy 230 V



click & scan

Art. nr.	d, ø [mm]	Inngangsstrøm	Støpseltype
359.048.P0.1	40-160	180	CEE 7/7

Tilbehør for rørbearbeidingsverktøy

Geberit koffert for sett avgrader



click & scan

Art. nr.	NRF nr.
359.930.00.1	1084091

Betjeningshjelpemidler

Fjernkontroller

Geberit Service-Handy



click & scan

Art. nr.	B [cm]	H [cm]	T [cm]
115.860.00.1	5	2	15

Geberit Clean-Handy



click & scan

Art. nr.	B [cm]	H [cm]	T [cm]
115.831.00.1	3,6	1,9	10,8



Vedlegg

Forkortelser	320
Index	322
Artikkelnummer	322
NRF nr.	342



Forkortelser

Forkortelser	Beskrivelse	Forkortelser	Beskrivelse
a	Delmål (cm)	K	Maksimal avkorting (cm)
A	Fremspring (cm)	k	Flens-hullskeldiameter (mm)
a1	Delmål (cm)	K1	Maksimal avkorting (cm)
A1	Fremspring (cm)	K2	Maksimal avkorting (cm)
A ²	Innvendig tverrsnittflate (cm ²)	K3	Maksimal avkorting (cm)
AB	Tilkoblingsområde (mm)	KL	Kabellengde (cm)
AB1	Tilkoblingsområde (mm)	Ks	maksimal avkorting ved speilsveising (cm)
AB2	Tilkoblingsområde (mm)	Ks1	maksimal avkorting ved speilsveising (cm)
AD	Tilkoblingsavstand (mm)	Ks2	maksimal avkorting ved speilsveising (cm)
AD1	Tilkoblingsavstand (mm)	Ks3	maksimal avkorting ved speilsveising (cm)
arc	Vinkel (°)	Ks4	maksimal avkorting ved speilsveising (cm)
b	Delmål (cm)	Ks5	maksimal avkorting ved speilsveising (cm)
B	Bredde (cm)	Ks6	maksimal avkorting ved speilsveising (cm)
B1	Bredde (cm)	L	Lengde (m)
B2	Bredde (cm)	l	Lengde delmål (cm)
B3	Bredde (cm)	L	Lengde (cm)
B4	Bredde (cm)	L1	Lengde (cm)
c	Flenshulldiameter (mm)	l1	Lengde delmål (cm)
D	Utvendig diameter (mm)	l2	Lengde delmål (cm)
d, ø	Utvendig diameter (mm)	L2	Lengde (cm)
D1	Utvendig diameter (mm)	l3	Lengde delmål (cm)
d1, ø	Utvendig diameter (mm)	L3	Lengde (cm)
d2, ø	Utvendig diameter (mm)	La	Lengdeutvidelse (cm)
d3, ø	Utvendig diameter (mm)	IK	Klemmelengde skrue (cm)
da	Utvendig rørdiameter (mm)	m	Skruehulldiameter (mm)
di, ø	Innvendig diameter (mm)	M	Metriske gjenger (mm)
di1, ø	Innvendig diameter (mm)	n	Antall skruer flensforbindelse (stk.)
DN	Nominell diameter	PN	Nominelt trykk (bar)
DN/OD	Nominell diameter	r	Radius (cm)
DN1	Nominell diameter	R	Kjedgeformede utvendige gjenger (")
E	Innstikksdybde (cm)	R1	Kjedgeformede utvendige gjenger (")
E1	Innstikksdybde (cm)	Rg	Rundgjenger (")
G	Rørgjenger (")	Rp	Innvendige rørgjenger kjedgeformet (")
G1	Rørgjenger (")		
G2	Rørgjenger (")		
h	Høyde delmål (cm)		
H	Høyde (cm)		
h1	Høyde delmål (cm)		
H1	Høyde (cm)		
H2	Høyde (cm)		
h2	Høyde delmål (cm)		
H3	Høyde (cm)		
h3	Høyde delmål (cm)		

Forkortelser	Beskrivelse
Rp1	Innvendige rørgjenger kjegleformet (")
Rp2	Innvendige rørgjenger kjegleformet (")
s	Veggtykkelse (mm)
S	Rørserie
s ISO	Veggtykkelse (for etiketter) (mm)
s1	Veggtykkelse (mm)
SW	Nøkkelvidde (mm)
T	Dybde (cm)
T1	Dybde (cm)
T2	Dybde (cm)
T3	Dybde (cm)
T4	Dybde (cm)
T5	Dybde (cm)
UNC	Tommegjenger
V	Måleområde volumstrøm (l/min)
X	Lårlengde / L-mål (cm)
X1	Lårlengde / L-mål (cm)
X2	Lårlengde / L-mål (cm)
X3	Lårlengde / L-mål (cm)
X4	Lårlengde / L-mål (cm)
X5	Lårlengde / L-mål (cm)
X6	Lårlengde / L-mål (cm)
Z	Z-mål (cm)
Z1	Z-mål (cm)
Z2	Z-mål (cm)
Z3	Z-mål (cm)
Z4	Z-mål (cm)
Z5	Z-mål (cm)
Z6	Z-mål (cm)



Index

Artikkelnummer

Artikkelnummer	Side	Artikkelnummer	Side	Artikkelnummer	Side	Artikkelnummer	Side
12412	19	20309	14	21005	15	21236	16
12413	19	20310	14	21006	15	21237	16
12414	19	20311	14	21007	15	21238	16
12415	19	20401	14	21008	15	21239	16
12416	19	20402	14	21009	15	21240	16
12417	19	20403	14	21010	15	21241	16
12418	19	20404	14	21011	15	21244	16
12419	19	20405	14	21101	16	21245	16
12420	19	20406	14	21103	16	21246	16
12421	19	20407	14	21104	16	21247	16
19201	10	20408	14	21105	16	21248	16
19202	10	20501	22	21107	16	21249	16
19203	10	20502	22	21120	17	21250	16
19204	10	20503	22	21121	17	21301	17
19205	10	20505	22	21122	17	21302	17
19206	10	20507	22	21123	17	21304	17
19207	10	20508	22	21127	17	21305	17
19208	10	20551	22	21128	17	21307	17
19402	11	20552	22	21130	17	21308	17
19403	11	20553	22	21131	17	21309	17
19404	11	20555	22	21133	17	21310	17
19405	11	20557	22	21134	17	21311	17
19406	11	20558	22	21201	16	21312	17
19407	11	20559	22	21202	16	21313	17
19408	11	20560	22	21203	16	21314	17
19409	11	20561	22	21204	16	21316	17
19410	11	20562	22	21205	16	21317	17
19411	11	20601	13	21206	16	21318	17
20101	13	20602	13	21207	16	21320	17
20102	13	20603	13	21208	16	21321	17
20103	13	20604	13	21209	16	21322	17
20104	13	20605	13	21210	16	21324	17
20105	13	20609	13	21211	16	21326	17
20109	13	20610	13	21212	16	21329	17
20110	13	20611	13	21213	16	21331	17
20111	13	20701	14	21214	16	21334	17
20211	26	20702	14	21215	16	21336	17
20212	26	20703	14	21216	16	21404	18
20213	26	20704	14	21217	16	21406	18
20214	26	20705	14	21218	16	21409	18
20215	26	20709	14	21219	16	21504	18
20216	26	20710	14	21220	16	21505	18
20217	26	20711	14	21221	16	21506	18
20218	26	20801	15	21222	16	21507	18
20219	26	20802	15	21223	16	21509	18
20220	26	20803	15	21224	16	21510	18
20221	26	20804	15	21225	16	21512	18
20301	14	20805	15	21226	16	21609	21
20302	14	21001	15	21230	16	21610	21
20303	14	21002	15	21231	16	21611	21
20304	14	21003	15	21232	16	21612	21
20305	14	21004	15	21233	16	21613	21

Artikkelnummer	Side	Artikkelnummer	Side	Artikkelnummer	Side	Artikkelnummer	Side
21615	21	21914	21	22317	12	23606	13
21618	21	21916	21	22318	12	23607	13
21659	22	21918	21	22320	12	23608	13
21660	22	21920	21	22321	12	23706	14
21661	22	21922	21	22322	12	23707	14
21662	22	21930	20	22323	12	23708	14
21700	20	21931	20	22324	12	23715	88
21701	20	21932	20	22330	12	23716	88
21702	20	21933	20	22331	12	23717	88
21703	20	21934	20	22338	12	23718	88
21704	20	21935	20	22339	12	23719	88
21705	20	21936	20	22345	12	23720	88
21707	20	21937	20	22346	12	23721	88
21708	20	21938	20	22348	12	23722	24
21709	20	21939	20	22349	12	23723	24
21710	20	21940	20	22421	24	23724	24
21711	20	22001	11	22422	24	23725	24
21713	20	22002	11	22423	24	23726	24
21714	20	22003	11	22431	24	23727	24
21715	20	22004	11	22432	24	23728	24
21716	20	22005	11	22433	24	23729	24
21717	20	22006	11	22444	24	23754	25
21719	20	22007	11	22951	26	23755	25
21720	20	22008	11	22952	26	23756	25
21721	20	22009	11	22953	26	23757	25
21722	20	22010	11	22954	26	23758	25
21724	20	22011	11	22955	26	23759	25
21725	20	22023	11	22956	26	23760	25
21727	20	22024	11	22958	26	23761	25
21800	21	22025	11	22959	27	23764	25
21801	21	22101	12	22960	27	23765	25
21802	21	22102	12	22962	27	23766	25
21803	21	22103	12	22964	27	23767	25
21804	21	22104	12	22965	27	23768	25
21805	21	22105	12	22966	27	23769	25
21806	21	22106	12	22967	27	23770	25
21807	21	22107	12	22968	27	23771	25
21808	21	22108	12	22969	27	23784	25
21809	21	22109	12	22970	27	23785	25
21810	21	22110	12	22971	27	23786	25
21811	21	22111	12	22972	27	23787	25
21814	21	22301	12	22974	27	23788	25
21818	21	22302	12	22983	27	23789	25
21820	21	22303	12	22984	27	23790	25
21823	21	22304	12	22985	27	23791	25
21824	21	22305	12	22987	27	23799	134
21827	21	22306	12	22989	27	23932	26
21901	21	22307	12	23106	13	23933	26
21902	21	22308	12	23107	13	23934	26
21903	21	22309	12	23108	13	23935	26
21904	21	22310	12	23306	14	23936	26
21905	21	22311	12	23307	14	23937	26
21906	21	22312	12	23308	14	23938	26
21907	21	22313	12	23509	22	23939	26
21908	21	22315	12	23510	22	23940	26
21910	21	22316	12	23511	22	23941	26



Artikkelnummer	Side	Artikkelnummer	Side	Artikkelnummer	Side	Artikkelnummer	Side
24002	28	30069	41	30935	41	31234	43
24003	28	30070	41	30936	41	31235	43
24004	28	30071	41	30937	41	31236	43
25032	24	30089	41	30938	41	31237	43
25033	24	30090	41	30942	41	31238	43
25034	24	30091	41	30943	41	31239	43
25035	24	30101	39	30944	41	31240	43
25036	24	30102	39	30955	41	31241	43
25037	24	30103	39	30956	41	31242	43
25038	24	30104	39	30957	41	31243	43
25045	24	30105	39	30958	41	31244	43
25046	24	30301	40	31002	42	31245	43
25300	23	30302	40	31003	42	31246	43
25302	23	30303	40	31004	42	31247	43
25304	23	30304	40	31005	42	31248	43
25305	23	30305	40	31006	42	31249	43
25306	23	30402	41	31007	42	31250	43
25307	23	30403	41	31008	42	31251	43
25308	23	30404	41	31009	42	31303	44
25309	23	30405	41	31010	42	31304	44
25319	23	30406	41	31011	42	31305	44
25320	23	30407	41	31106	39	31306	44
25321	23	30408	41	31107	39	31307	44
25322	23	30414	42	31108	39	31308	44
25323	23	30415	42	31109	39	31309	44
25324	23	30601	39	31110	39	31310	44
25325	23	30602	39	31111	39	31311	44
25326	23	30603	39	31204	43	31312	44
25329	23	30604	39	31206	43	31313	44
25330	23	30605	39	31207	43	31314	44
25332	23	30701	40	31208	43	31316	44
25335	23	30702	40	31209	43	31317	44
25337	23	30703	40	31210	43	31318	44
25338	23	30704	40	31211	43	31320	44
25339	23	30705	40	31212	43	31321	44
25340	23	30802	42	31213	43	31322	44
29101	10	30803	42	31214	43	31324	44
29102	10	30804	42	31215	43	31326	44
29103	10	30805	42	31216	43	31329	44
29104	10	30872	41	31217	43	31331	44
29105	10	30873	41	31218	43	31334	44
29106	10	30874	41	31219	43	31336	44
29107	10	30875	41	31220	43	31339	44
29108	10	30876	41	31221	43	31401	44
29159	10	30877	41	31222	43	31454	44
29160	10	30878	41	31223	43	31455	44
29161	10	30892	41	31224	43	31458	44
30009	41	30893	41	31225	43	31461	44
30010	41	30894	41	31226	43	31464	44
30011	41	30905	41	31227	43	31703	47
30029	41	30906	41	31228	43	31704	47
30030	41	30907	41	31229	43	31705	47
30031	41	30908	41	31230	43	31707	47
30049	41	30932	41	31231	43	31708	47
30050	41	30933	41	31232	43	31709	47
30051	41	30934	41	31233	43	31710	47

Artikkelnummer	Side	Artikkelnummer	Side	Artikkelnummer	Side	Artikkelnummer	Side
31711	47	32006	37	32414	45	33735	54
31713	47	32007	37	32415	45	33736	54
31714	47	32008	37	32416	45	33737	54
31715	47	32009	37	32417	45	33738	54
31716	47	32010	37	32418	45	33739	54
31717	47	32011	37	32419	45	33740	54
31718	47	32050	37	32420	45	33741	54
31719	47	32051	37	32421	45	33744	54
31720	47	32052	37	32606	39	33745	54
31721	47	32053	37	32607	39	33746	54
31722	47	32054	37	32608	39	33747	54
31724	47	32055	37	32609	39	33748	54
31726	47	32056	37	32610	39	33749	54
31731	48	32057	37	32611	39	33750	54
31732	48	32058	37	32706	40	33752	54
31733	48	32059	37	32707	40	33802	50
31734	48	32101	37	32708	40	33803	50
31735	48	32102	37	32709	40	33804	50
31736	48	32103	37	32710	40	33805	50
31737	48	32104	37	32711	40	33806	50
31801	49	32105	37	33001	37	33807	50
31802	49	32106	37	33002	38	33833	50
31803	49	32107	37	33003	38	33834	50
31804	49	32108	37	33004	38	33835	50
31805	49	32109	37	33005	43	33836	50
31806	49	32110	37	33008	42	33837	50
31807	49	32111	37	33009	47	33838	50
31809	49	32303	38	33010	49	33839	50
31811	49	32305	38	33013	56	33846	49
31814	49	32306	38	33017	47	33848	49
31818	49	32307	38	33018	49	33850	49
31819	49	32308	38	33203	50	33852	49
31820	49	32309	38	33212	56	33854	49
31821	49	32310	38	33213	56	33860	49
31822	49	32311	38	33214	56	33862	49
31823	49	32312	38	33215	56	33864	49
31824	49	32313	38	33216	56	33932	55
31825	49	32314	38	33217	56	33933	55
31826	49	32315	38	33218	56	33934	55
31833	48	32316	38	33219	56	33935	55
31837	48	32317	38	33220	56	33936	55
31838	48	32318	38	33221	56	33937	55
31839	48	32319	38	33306	40	33938	55
31840	48	32320	38	33307	40	33939	55
31841	48	32321	38	33308	40	33940	55
31932	48	32322	38	33309	40	33941	55
31933	48	32323	38	33310	40	34000	59
31936	48	32324	38	33311	40	34001	59
31937	48	32331	38	33403	56	34002	59
31938	48	32338	38	33405	56	34003	59
31939	48	32339	38	33406	56	34007	60
31940	48	32345	38	33407	56	34008	60
32002	37	32346	38	33503	56	34009	60
32003	37	32348	38	33732	54	34010	60
32004	37	32412	45	33733	54	34014	59
32005	37	32413	45	33734	54	34015	59



Artikkelnummer	Side	Artikkelnummer	Side	Artikkelnummer	Side	Artikkelnummer	Side
34016	59	34079	62	34138	68	34271	63
34017	59	34080	62	34139	68	34285	62
34021	60	34081	62	34140	62	34286	62
34022	60	34082	62	34141	62	34287	62
34023	60	34083	64	34142	63	34296	59
34024	60	34084	64	34143	63	34297	59
34028	62	34085	62	34144	65	34298	59
34029	62	34086	64	34145	65	34346	63
34030	62	34087	64	34146	65	34347	64
34031	62	34088	62	34147	65	34400	66
34032	62	34089	64	34148	65	34401	66
34033	62	34090	64	34149	65	34402	66
34034	62	34091	64	34150	65	34403	66
34035	62	34092	64	34151	65	34404	66
34036	62	34093	64	34152	65	34405	66
34037	62	34094	62	34153	65	34406	66
34038	62	34095	62	34154	65	34407	66
34039	62	34096	62	34158	66	34408	66
34040	62	34097	62	34159	66	34409	66
34041	62	34098	62	34161	66	34430	66
34042	62	34099	62	34162	58	34431	66
34043	62	34101	58	34169	64	34432	66
34044	62	34102	58	34170	64	34433	66
34045	62	34103	58	34187	59	34434	66
34046	62	34104	58	34188	59	34435	66
34047	62	34105	58	34189	59	34436	66
34048	62	34106	58	34190	60	34437	66
34049	62	34107	58	34191	60	34438	66
34050	62	34108	58	34192	60	34439	66
34051	62	34109	58	34193	59	34440	66
34052	63	34110	58	34194	59	34441	59
34053	63	34111	58	34195	59	34442	59
34054	63	34112	58	34196	60	34443	59
34055	63	34113	58	34197	60	34444	60
34056	63	34114	58	34198	60	34445	60
34057	63	34115	59	34204	67	34446	60
34058	63	34116	59	34205	67	34447	59
34059	63	34117	59	34206	67	34448	59
34060	63	34118	59	34207	67	34449	59
34061	63	34119	59	34208	67	34450	60
34062	62	34120	59	34209	67	34451	60
34063	63	34121	58	34210	67	34452	60
34065	62	34122	58	34211	67	34462	68
34066	63	34123	59	34248	58	34463	68
34067	63	34124	59	34249	58	34464	68
34068	63	34125	62	34250	58	34465	68
34069	63	34126	63	34259	59	34466	68
34070	63	34127	59	34260	59	34467	68
34071	63	34128	59	34261	59	34468	68
34072	63	34129	59	34264	63	34469	68
34073	63	34132	59	34265	63	34470	68
34074	63	34133	59	34266	63	34471	68
34075	63	34134	59	34267	63	34500	94
34076	63	34135	59	34268	63	34501	94
34077	63	34136	68	34269	63	34502	94
34078	63	34137	68	34270	63	34503	94

Artikkelnummer	Side	Artikkelnummer	Side	Artikkelnummer	Side	Artikkelnummer	Side
34504	94	34606	93	34736	96	35339	52
34505	94	34607	93	34737	96	35340	52
34506	94	34608	93	34738	96	35350	53
34507	94	34609	93	34739	96	35351	53
34508	94	34610	93	34752	99	35352	53
34509	94	34611	93	34753	99	35353	53
34510	94	34612	93	34754	99	35354	53
34511	94	34613	93	34755	99	35355	53
34512	94	34614	93	34756	99	35356	53
34513	94	34615	93	34757	99	35357	53
34514	94	34616	93	34758	99	35358	53
34515	94	34617	93	35032	51	35359	53
34516	94	34618	93	35033	51	35360	52
34517	94	34619	93	35034	51	35361	52
34518	94	34620	93	35035	51	35362	52
34519	94	34623	93	35036	51	35363	52
34520	94	34624	93	35037	51	35364	52
34521	94	34625	93	35038	51	35365	52
34522	94	34626	93	35039	51	35366	52
34523	94	34627	93	35040	51	35367	52
34524	94	34628	93	35042	51	35368	52
34525	94	34629	93	35044	51	35369	52
34526	94	34666	97	35045	51	35370	52
34527	94	34667	97	35046	51	35380	53
34528	96	34669	97	35047	51	35382	53
34529	96	34670	97	35072	51	35384	53
34530	96	34671	97	35075	51	35386	53
34531	96	34672	97	35132	51	35387	53
34532	96	34673	97	35133	51	35388	53
34533	96	34674	97	35134	51	35389	53
34534	96	34675	97	35300	53	35390	51
34535	96	34676	97	35301	53	35391	51
34536	96	34677	97	35302	53	35392	51
34537	96	34678	97	35303	53	35393	51
34543	96	34679	97	35304	53	35394	51
34544	96	34683	97	35305	53	35395	51
34545	96	34684	97	35306	53	35396	51
34546	96	34685	97	35307	53	35400	52
34547	96	34686	97	35308	53	35402	52
34548	96	34687	97	35309	53	35405	52
34549	96	34688	97	35320	50	35407	52
34550	96	34689	97	35321	50	35408	52
34551	96	34690	97	35322	50	35409	52
34552	98	34691	97	35323	50	35410	52
34553	96	34692	97	35324	50	36101	39
34554	96	34693	97	35325	50	36103	39
34556	98	34725	98	35326	50	36104	39
34557	98	34726	98	35330	52	36105	39
34588	96	34727	98	35331	52	36106	39
34589	96	34728	98	35332	52	36107	39
34590	96	34729	98	35333	52	36108	39
34601	93	34730	98	35334	52	36109	39
34602	93	34731	99	35335	52	36110	39
34603	93	34732	99	35336	52	36111	40
34604	93	34733	99	35337	52	36113	40
34605	93	34735	96	35338	52	36114	40



Artikkelnummer	Side	Artikkelnummer	Side	Artikkelnummer	Side	Artikkelnummer	Side
36115	40	39008	57	60102	78	60803	79
36116	40	39009	57	60103	78	60804	79
36117	40	39010	57	60104	78	60875	79
36118	40	39011	57	60105	78	60876	79
36119	40	39012	36	60106	78	60878	79
36120	40	56319	108	60107	78	60905	79
36121	39	56322	108	60108	78	60906	79
36123	39	56323	108	60111	78	60907	79
36124	39	56324	108	60112	78	60908	79
36125	39	56325	108	60113	78	60935	79
36126	39	56326	108	60231	89	60936	79
36127	39	56327	108	60232	89	60937	79
36128	39	56328	108	60233	89	60938	79
36129	39	56329	108	60234	89	60955	79
36130	39	60001	91	60235	89	60956	79
36131	40	60002	91	60236	89	60957	79
36133	40	60003	91	60237	89	61000	80
36134	40	60004	91	60238	89	61002	80
36135	40	60005	91	60240	89	61003	80
36136	40	60006	91	60241	89	61004	80
36137	40	60007	91	60242	89	61005	80
36138	40	60008	91	60301	78	61006	80
36139	40	60009	91	60302	78	61007	80
36140	40	60010	92	60303	78	61008	80
36141	55	60011	92	60304	78	61011	80
36142	55	60012	92	60305	78	61012	80
36143	55	60013	92	60306	78	61013	80
36144	55	60014	92	60307	79	61212	80
36145	55	60015	92	60308	79	61213	80
36146	55	60016	92	60311	79	61214	80
36147	55	60017	92	60312	79	61215	80
36148	55	60018	90	60313	79	61218	80
36161	39	60019	90	60601	78	61219	80
36163	39	60020	90	60602	78	61220	80
36164	39	60021	90	60603	78	61225	80
36165	39	60022	90	60604	78	61226	80
36166	39	60023	90	60605	78	61227	80
36167	39	60025	91	60606	78	61228	80
36168	39	60026	91	60607	78	61229	80
36169	39	60027	92	60608	78	61235	80
36170	39	60028	92	60611	78	61240	80
36171	40	60029	90	60612	78	61242	80
36173	40	60030	91	60613	78	61244	80
36174	40	60031	91	60701	78	61252	80
36175	40	60032	91	60702	78	61253	80
36176	40	60033	92	60703	78	61254	80
36177	40	60034	92	60704	78	61256	80
36178	40	60035	92	60705	78	61257	80
36179	40	60082	79	60706	78	61259	80
36180	40	60083	79	60707	78	61260	80
39002	57	60084	79	60708	78	61261	80
39003	57	60085	79	60711	78	61275	45
39004	57	60086	79	60712	78	61276	45
39005	57	60087	79	60713	78	61283	80
39006	57	60088	79	60801	79	61284	80
39007	57	60101	78	60802	79	61285	80

Artikkelnummer	Side	Artikkelnummer	Side	Artikkelnummer	Side	Artikkelnummer	Side
61286	80	61819	85	62334	77	65044	87
61288	80	61820	85	62336	77	65045	87
61289	80	61821	85	62337	77	65046	87
61290	80	61823	85	62338	77	65050	87
61292	80	61824	85	62340	77	65051	87
61293	81	61825	85	62341	77	65052	87
61294	81	61845	85	63452	89	65053	87
61296	81	61846	85	63453	89	65054	87
61297	81	61932	84	63455	89	65081	87
61352	81	61933	84	63457	89	65082	87
61354	81	61935	84	63458	89	65083	87
61355	81	61936	84	63459	89	65084	87
61357	81	62001	76	63460	89	65085	87
61359	81	62002	76	63462	89	65086	87
61360	81	62003	76	63463	89	65087	87
61362	81	62004	76	63464	89	65088	87
61366	81	62005	76	63473	90	65090	87
61370	81	62006	76	63558	85	65091	87
61395	81	62007	76	63559	85	65182	87
61404	82	62008	76	63560	85	65382	87
61406	82	62011	76	63561	85	65384	87
61409	82	62012	76	63562	85	65385	87
61504	82	62013	76	63564	85	65386	87
61505	82	62024	82	63565	85	65387	87
61506	82	62050	76	63706	88	65388	87
61701	84	62055	76	63707	88	65392	87
61702	84	62102	76	63708	88	65481	86
61703	84	62103	76	63709	88	65482	86
61704	84	62104	76	63711	88	65483	86
61705	84	62105	76	63712	88	65484	86
61707	84	62106	76	63713	88	65485	86
61708	84	62107	76	63789	134	65486	86
61709	84	62108	76	63853	86	65487	86
61710	84	62111	76	63854	86	65488	86
61711	84	62112	76	63855	86	65490	86
61714	84	62113	76	63856	86	65491	86
61715	84	62301	77	63857	86	65492	86
61716	84	62302	77	63860	86	65531	86
61717	84	62303	77	63861	86	65532	86
61718	84	62305	77	63862	86	65533	86
61719	84	62306	77	63863	86	65534	86
61721	84	62307	77	63864	86	65535	86
61732	84	62308	77	63865	86	65536	86
61733	84	62309	77	63866	86	65537	86
61734	84	62312	77	63873	85	65538	86
61745	84	62313	77	63884	85	65540	86
61801	85	62316	77	63885	85	65541	86
61802	85	62317	77	63886	85	65542	86
61803	85	62318	77	63887	85	65543	86
61804	85	62322	77	63888	85	65544	86
61805	85	62323	77	63889	85	67002	108
61806	85	62324	77	63892	85	67004	108
61809	85	62329	77	63893	85	67005	108
61811	85	62330	77	63894	85	67006	108
61814	85	62331	77	63895	85	67007	108
61818	85	62333	77	65040	87	67008	108



Artikkelnummer	Side	Artikkelnummer	Side	Artikkelnummer	Side	Artikkelnummer	Side
67009	108	67318	109	67707	111	68701	116
67010	108	67323	109	67708	111	68703	114
67011	108	67324	109	67709	111	68707	114
67102	109	67325	109	67710	111	68708	114
67104	109	67327	109	67711	111	68709	114
67105	109	67330	109	67802	114	68710	114
67106	109	67337	109	67805	114	68711	114
67107	109	67338	109	67806	114	68715	114
67108	109	67344	113	67809	114	68716	110
67109	109	67346	109	67811	114	68718	110
67110	109	67347	113	67814	114	68719	110
67111	109	67348	113	67818	114	68720	110
67206	113	67349	113	68002	112	68721	110
67209	113	67350	113	68004	112	68722	110
67211	113	67352	113	68005	112	68723	110
67212	113	67353	113	68006	112	68724	110
67214	113	67356	113	68007	112	68725	110
67215	113	67357	113	68008	112	68726	111
67218	113	67360	113	68009	112	68728	111
67219	113	67361	113	68010	112	68729	111
67220	113	67366	113	68011	112	68730	111
67225	113	67369	113	68102	110	68731	111
67226	113	67373	113	68104	110	68732	111
67227	113	67402	112	68105	110	68733	111
67228	113	67404	112	68106	110	68734	111
67229	113	67405	112	68107	110	68735	111
67230	113	67406	112	68108	110	68736	110
67231	113	67407	112	68109	110	68738	110
67232	115	67408	112	68110	110	68739	110
67233	113	67503	115	68111	110	68740	110
67234	115	67506	115	68302	111	68741	110
67235	115	67507	115	68304	111	68742	110
67236	115	67508	115	68305	111	68743	110
67237	115	67509	115	68306	111	68744	110
67238	115	67510	115	68307	111	68745	110
67239	113	67511	115	68308	111	68746	111
67243	115	67515	115	68309	111	68748	111
67244	113	67516	115	68310	111	68749	111
67245	113	67517	115	68311	111	68750	111
67246	113	67518	115	68682	116	68751	111
67247	113	67519	115	68684	116	68752	111
67248	113	67520	115	68685	116	68753	111
67250	113	67521	115	68686	116	68754	111
67251	113	67602	110	68687	116	68755	111
67252	113	67604	110	68688	116	68756	116
67253	113	67605	110	68689	116	68757	116
67260	113	67606	110	68690	116	68758	116
67261	113	67607	110	68691	116	68759	116
67269	113	67608	110	68692	116	68760	116
67270	113	67609	110	68694	116	68761	116
67305	109	67610	110	68695	116	68762	116
67307	109	67611	110	68696	116	68763	116
67309	109	67702	111	68697	116	68791	117
67312	109	67704	111	68698	116	68793	117
67313	109	67705	111	68699	116	68794	117
67317	109	67706	111	68700	116	68795	117

Artikkelnummer	Side	Artikkelnummer	Side	Artikkelnummer	Side	Artikkelnummer	Side
68796	117	90405	29	91159	70	94935	164
68797	117	90406	29	91160	70	94936	164
68798	117	90407	29	91161	70	94937	164
68799	117	90408	29	92080	117	94938	164
68804	110	90409	29	92082	117	94952	163
68806	110	90410	29	92083	117	94953	163
68807	110	90411	29	92084	117	94954	163
68808	110	90523	281	92085	117	94955	163
68809	110	90797	290	92086	117	94956	163
68810	110	90798	290	92087	117	94957	163
68811	110	90799	290	92088	117	94958	163
68812	110	90881	29	92089	117	94962	164
68813	110	90882	29	92100	164	94963	164
68814	111	90883	29	92101	164	94964	164
68816	111	90884	29	92102	164	94965	164
68817	111	90885	29	92103	164	94966	164
68818	111	90886	29	92104	164	94967	164
68819	111	90887	29	92105	164	94968	164
68820	111	90888	29	92106	164	115.335.00.1	169
68821	111	90891	29	92107	164	115.831.00.1	317
68822	111	90892	29	92108	164	115.860.00.1	317
68823	111	90893	29	92109	164	115.861.00.6	170
68833	114	90922	293	92120	165	116.098.00.1	171
68837	114	90923	293	92122	165	116.109.00.6	169
68838	114	90924	293	92123	165	116.110.00.6	169
68839	114	90925	293	92124	165	152.153.16.1	236
68840	114	90926	293	92125	165	152.155.16.1	236
68841	114	90927	293	92126	165	152.197.16.1	236
90080	30	90928	293	92127	165	152.198.16.1	236
90081	30	90932	49	92128	165	152.495.00.1	203
90082	30	90933	49	92129	165	152.496.00.1	203
90083	30	90934	49	92140	165	152.682.00.1	203
90084	30	90935	49	92142	165	152.689.00.1	203
90085	30	90936	49	92143	165	152.690.00.1	203
90086	30	90980	55	92144	165	152.691.00.1	203
90088	30	90981	55	92145	165	152.692.00.1	203
90089	30	90982	55	92146	165	152.693.00.1	203
90092	30	90983	55	92147	165	152.796.00.1	203
90094	30	90984	55	92148	165	153.564.16.1	203
90095	30	90985	55	92149	165	153.565.16.1	203
90096	30	90986	55	92150	165	153.566.16.1	203
90097	30	90987	55	92152	165	241.521.00.1	243
90098	30	90988	55	92153	165	241.595.00.1	168
90351	292	90989	55	92154	165	241.785.00.1	203
90357	292	91087	291	92155	165	241.786.00.1	186
90363	292	91088	291	92156	165	241.787.00.1	186
90371	292	91092	292	92157	165	241.790.00.1	186
90372	292	91105	99	92158	165	241.791.00.1	186
90373	292	91106	99	92159	165	242.278.00.1	203
90374	292	91152	70	94922	163	242.279.00.1	186
90375	292	91153	70	94923	163	242.280.00.1	186
90376	292	91154	70	94924	163	242.614.P1.1	280
90401	29	91155	70	94925	163	242.737.00.1	45
90402	29	91156	70	94926	163	242.828.00.1	314
90403	29	91157	70	94927	163	242.923.00.1	252
90404	29	91158	70	94928	163	242.924.00.1	252



Artikkelnummer	Side	Artikkelnummer	Side	Artikkelnummer	Side	Artikkelnummer	Side
242.925.00.1	252	308.003.14.3	214	310.880.14.1	209	356.013.00.1	271
242.926.00.1	252	308.005.14.1	218	310.921.00.1	270	356.014.00.1	271
242.927.00.1	252	308.012.14.1	214	312.000.14.1	208	356.015.00.1	271
242.928.00.1	252	308.014.14.1	209	312.002.14.1	214	356.016.00.1	271
242.929.00.1	252	308.050.14.1	212	312.003.14.3	214	356.118.00.1	315
242.930.00.1	252	308.054.14.1	210	312.005.14.1	218	357.599.00.1	313
242.931.00.1	252	308.058.14.1	211	312.012.14.1	214	357.600.00.1	313
300.007.00.2	270	308.070.14.1	212	312.014.14.1	209	357.800.00.1	314
305.000.14.1	208	308.074.14.1	210	312.100.14.1	213	358.033.00.1	264
305.002.14.1	214	308.078.14.1	211	312.104.14.1	210	358.061.00.1	267
305.003.14.3	214	308.081.14.1	212	312.108.14.1	211	358.062.00.1	267
305.005.14.1	218	308.084.14.1	210	312.109.14.1	211	358.501.00.1	316
305.040.14.3	216	308.088.14.1	211	312.124.14.1	210	358.503.00.1	314
305.054.14.1	210	308.089.14.1	211	312.125.14.1	213	358.504.00.1	314
305.058.14.1	211	308.150.14.1	208	312.128.14.1	211	358.759.00.1	313
305.150.14.1	208	308.300.14.1	208	312.140.00.2	215	358.760.00.1	313
305.300.14.1	208	308.450.14.1	208	312.150.14.1	208	359.042.00.1	266
305.450.14.1	208	308.600.14.1	209	312.300.14.1	208	359.046.P2.1	312
305.600.14.1	209	308.670.14.1	208	312.333.14.1	213	359.046.P3.1	311
305.670.14.1	208	308.812.26.1	217	312.450.14.1	208	359.046.P5.1	311
305.812.26.1	217	308.815.14.1	212	312.600.14.1	209	359.046.P6.1	311
305.880.14.1	209	308.817.14.1	212	312.771.16.1	213	359.046.P7.1	311
305.904.14.1	216	308.880.14.1	209	312.812.26.1	217	359.046.P9.1	311
305.905.14.1	216	308.921.00.1	270	312.813.26.1	217	359.046.Q4.1	311
305.906.14.1	216	310.000.14.1	208	312.880.14.1	209	359.048.P0.1	317
305.921.00.1	270	310.002.14.1	214	312.885.14.1	209	359.052.00.1	313
306.000.14.1	208	310.003.14.3	214	312.921.00.1	270	359.053.00.1	313
306.002.14.1	214	310.005.14.1	218	315.001.14.1	208	359.054.00.1	313
306.054.14.1	210	310.012.14.1	214	315.002.14.1	214	359.056.00.1	313
306.064.14.1	210	310.014.14.1	209	315.003.14.3	214	359.057.00.1	313
306.450.14.1	208	310.048.14.1	210	315.005.14.1	218	359.067.00.1	266
306.812.26.1	217	310.050.14.1	213	315.012.14.1	214	359.082.P2.1	313
306.880.14.1	209	310.054.14.1	210	315.100.14.1	213	359.082.P3.1	311
306.921.00.1	270	310.058.14.1	211	315.104.14.1	210	359.082.P5.1	311
307.000.14.1	208	310.070.14.1	213	315.108.14.1	211	359.082.P6.1	311
307.002.14.1	214	310.074.14.1	210	315.124.14.1	210	359.082.P7.1	311
307.003.14.3	214	310.078.14.1	211	315.126.14.1	213	359.082.P9.1	311
307.005.14.1	218	310.080.14.1	213	315.128.14.1	211	359.082.Q4.1	311
307.012.14.1	214	310.081.14.1	212	315.144.14.1	210	359.098.00.1	260
307.050.14.1	212	310.084.14.1	210	315.148.14.1	211	359.100.00.1	261
307.054.14.1	210	310.088.14.1	211	315.300.14.1	208	359.105.00.1	259
307.058.14.1	211	310.101.14.1	212	315.333.14.1	213	359.107.00.1	259
307.060.14.1	212	310.102.14.1	211	315.450.14.1	208	359.111.00.1	261
307.074.14.1	210	310.104.14.1	210	315.812.26.1	217	359.112.00.1	261
307.078.14.1	211	310.108.14.1	211	315.813.26.1	217	359.113.00.1	262
307.150.14.1	208	310.115.14.1	212	315.885.14.1	209	359.114.00.1	262
307.300.14.1	208	310.117.14.1	212	348.300.00.1	270	359.115.00.1	260
307.333.14.1	213	310.150.14.1	208	348.301.00.1	270	359.117.00.1	259
307.450.14.1	208	310.300.14.1	208	348.302.00.1	270	359.118.00.1	260
307.600.14.1	209	310.334.14.1	213	348.303.00.1	270	359.119.00.1	265
307.670.14.1	208	310.450.14.1	208	348.304.00.1	270	359.120.00.1	265
307.812.26.1	217	310.600.14.1	209	348.305.00.1	270	359.122.00.1	265
307.880.14.1	209	310.670.14.1	208	348.306.00.1	270	359.123.00.1	267
307.921.00.1	270	310.812.26.1	217	356.010.00.1	271	359.124.00.1	266
308.000.14.1	208	310.815.14.1	212	356.011.00.1	271	359.126.00.1	265
308.002.14.1	214	310.817.14.1	212	356.012.00.1	271	359.140.00.1	235

Artikkelnummer	Side	Artikkelnummer	Side	Artikkelnummer	Side	Artikkelnummer	Side
359.141.00.1	235	359.778.00.1	312	360.850.00.1	137	362.826.26.1	248
359.142.00.1	235	359.809.00.1	313	360.861.00.1	263	362.827.26.1	248
359.153.14.1	186	359.811.00.1	313	361.000.16.0	222	362.828.26.1	217
359.226.16.1	236	359.812.00.1	313	361.045.16.1	222	362.833.00.1	250
359.229.16.1	236	359.813.00.1	313	361.055.16.1	223	362.834.26.1	28
359.309.00.1	238	359.814.00.1	313	361.061.16.1	242	362.836.00.1	217
359.311.00.1	238	359.816.00.1	313	361.065.16.1	242	362.837.26.1	249
359.313.00.1	238	359.817.00.1	313	361.080.16.1	241	362.839.26.1	249
359.424.00.2	234	359.818.00.1	313	361.088.16.1	222	362.843.26.1	250
359.425.00.2	215	359.819.00.1	313	361.109.16.1	225	362.844.26.1	250
359.426.00.2	215	359.822.00.1	313	361.112.16.1	225	362.848.26.1	28
359.427.00.2	215	359.832.00.1	316	361.159.16.1	226	362.851.26.1	29
359.428.00.2	215	359.844.00.1	316	361.162.16.1	226	362.852.26.1	249
359.429.00.2	215	359.860.00.1	314	361.459.16.1	229	362.853.26.1	249
359.430.00.2	215	359.884.00.1	314	361.462.16.1	229	362.854.26.1	249
359.431.00.2	234	359.900.00.1	274	361.557.16.1	230	362.862.26.1	263
359.432.00.2	215	359.910.P0.1	309	361.558.16.1	229	362.863.26.1	262
359.433.00.2	215	359.911.P0.1	309	361.559.16.1	230	362.864.26.1	262
359.434.00.2	185	359.912.00.1	315	361.700.16.1	233	362.865.26.1	263
359.435.00.2	185	359.915.00.1	315	361.719.16.1	238	363.000.16.0	222
359.436.00.2	215	359.916.00.1	315	361.720.16.1	238	363.045.16.1	222
359.437.00.2	185	359.917.00.1	315	361.721.16.1	238	363.055.16.1	223
359.438.00.2	215	359.922.00.1	316	361.722.16.1	238	363.088.16.1	222
359.439.00.2	215	359.923.00.1	316	361.723.16.1	238	363.112.16.1	225
359.440.00.2	215	359.924.00.1	316	361.726.16.1	238	363.115.16.1	225
359.441.00.2	185	359.925.00.1	316	361.727.16.1	238	363.162.16.1	226
359.442.00.2	215	359.926.00.1	316	361.740.16.1	237	363.165.16.1	226
359.443.00.2	234	359.930.00.1	317	361.742.00.1	253	363.462.16.1	229
359.444.00.2	185	359.969.00.1	274	361.743.26.1	240	363.463.16.1	243
359.445.00.2	234	359.971.00.1	265	361.744.16.1	240	363.465.16.1	229
359.446.00.2	215	360.000.16.0	222	361.745.00.1	240	363.472.16.1	244
359.447.00.2	234	360.045.16.1	222	361.746.00.1	239	363.558.16.1	229
359.448.00.2	215	360.055.16.1	223	361.748.00.1	239	363.559.16.1	230
359.449.00.2	185	360.108.16.1	225	361.750.16.1	237	363.560.16.1	230
359.450.00.2	215	360.109.16.1	225	361.768.16.1	244	363.561.16.1	229
359.451.00.2	234	360.158.16.1	226	361.771.16.1	232	363.700.16.1	233
359.454.00.1	235	360.159.16.1	226	361.772.16.1	241	363.724.16.1	238
359.455.00.1	235	360.557.16.1	230	361.776.16.1	248	363.728.16.1	238
359.456.00.1	235	360.700.16.1	233	361.779.16.3	234	363.740.16.1	237
359.457.00.1	235	360.719.16.1	238	361.782.16.1	254	363.742.00.1	253
359.458.00.1	235	360.720.16.1	238	361.783.00.1	254	363.744.16.1	240
359.459.00.1	235	360.721.16.1	238	361.784.16.1	236	363.745.00.1	240
359.461.16.1	235	360.740.16.1	237	361.789.00.1	252	363.746.00.1	239
359.462.00.1	235	360.750.16.1	237	361.802.92.1	251	363.748.00.1	239
359.463.00.1	235	360.770.16.1	244	361.812.16.1	251	363.750.16.1	237
359.464.00.1	235	360.771.16.1	232	361.822.00.1	264	363.771.16.1	213
359.465.00.2	185	360.772.16.1	241	361.832.00.2	247	363.772.16.1	241
359.504.00.1	266	360.779.16.3	234	361.841.00.2	246	363.776.16.1	248
359.575.00.1	264	360.780.16.1	237	361.843.00.2	246	363.779.16.3	234
359.577.00.1	264	360.782.16.1	254	361.850.00.1	137	363.780.16.1	237
359.591.00.1	264	360.783.00.1	254	361.861.00.1	263	363.782.16.1	254
359.635.00.1	266	360.812.16.1	251	361.872.16.1	224	363.783.00.1	254
359.641.P0.2	312	360.822.00.1	264	362.769.00.1	252	363.789.00.1	252
359.665.P0.2	312	360.832.00.2	247	362.771.00.1	252	363.812.16.1	251
359.675.P0.2	312	360.841.00.2	246	362.790.00.1	252	363.822.00.1	264
359.720.00.1	316	360.843.00.2	246	362.796.92.1	255	363.832.00.2	247



Artikkelnummer	Side	Artikkelnummer	Side	Artikkelnummer	Side	Artikkelnummer	Side
363.841.00.2	246	365.112.16.1	225	366.055.16.1	223	366.876.16.1	224
363.842.00.1	246	365.115.16.1	225	366.061.16.1	242	366.887.16.1	245
363.843.00.2	246	365.120.16.1	225	366.088.16.1	222	366.913.16.1	242
363.850.00.1	250	365.125.16.1	225	366.109.16.1	225	366.914.16.1	243
363.861.00.1	263	365.159.16.1	226	366.112.16.1	225	366.925.16.1	242
363.873.16.1	224	365.162.16.1	226	366.115.16.1	225	366.941.16.1	245
364.000.16.0	222	365.165.16.1	226	366.120.16.1	225	367.000.16.0	222
364.045.16.1	222	365.170.16.1	226	366.125.16.1	225	367.009.16.1	199
364.055.16.1	223	365.175.16.1	226	366.130.16.1	225	367.015.16.1	223
364.088.16.1	222	365.275.16.1	228	366.159.16.1	226	367.030.16.1	223
364.109.16.1	225	365.325.16.1	227	366.162.16.1	226	367.045.16.1	222
364.112.16.1	225	365.375.16.1	227	366.165.16.1	226	367.046.16.1	223
364.115.16.1	225	365.451.16.1	231	366.170.16.1	226	367.055.16.1	223
364.120.16.1	225	365.465.16.1	229	366.175.16.1	226	367.070.16.1	242
364.162.16.1	226	365.470.16.1	229	366.180.16.1	226	367.088.16.1	222
364.165.16.1	226	365.472.16.1	244	366.280.16.1	228	367.109.16.1	225
364.170.16.1	226	365.558.16.1	229	366.330.16.1	227	367.112.16.1	225
364.270.16.1	228	365.559.16.1	230	366.451.16.1	231	367.115.16.1	225
364.451.16.1	231	365.560.16.1	230	366.550.16.1	236	367.120.16.1	225
364.462.16.1	229	365.561.16.1	229	366.559.16.1	230	367.125.16.1	225
364.558.16.1	229	365.565.16.1	230	366.560.16.1	230	367.130.16.1	225
364.559.16.1	230	365.566.16.1	229	366.561.16.1	229	367.135.16.1	225
364.560.16.1	230	365.570.16.1	230	366.565.16.1	230	367.159.16.1	226
364.561.16.1	229	365.571.16.1	229	366.566.16.1	229	367.162.16.1	226
364.565.16.1	230	365.605.16.1	228	366.570.16.1	230	367.163.16.1	226
364.566.16.1	229	365.700.16.1	233	366.571.16.1	229	367.165.16.1	226
364.700.16.1	233	365.725.16.1	238	366.575.16.1	230	367.170.16.1	226
364.724.16.1	238	365.729.16.1	238	366.576.16.1	229	367.175.16.1	226
364.728.16.1	238	365.730.16.1	245	366.605.16.1	228	367.180.16.1	226
364.730.16.1	245	365.740.16.1	237	366.700.16.1	233	367.185.16.1	226
364.740.16.1	237	365.742.00.1	253	366.740.16.1	237	367.235.16.1	227
364.744.16.1	240	365.744.16.1	240	366.742.00.1	253	367.262.16.1	228
364.750.16.1	237	365.745.00.1	240	366.743.26.1	240	367.265.16.1	228
364.771.16.1	213	365.746.00.1	239	366.744.16.1	240	367.270.16.1	228
364.772.16.1	241	365.748.00.1	239	366.745.00.1	240	367.275.16.1	228
364.776.16.1	248	365.750.16.1	237	366.746.00.1	239	367.280.16.1	228
364.779.16.3	234	365.771.16.1	213	366.748.00.1	239	367.285.16.1	228
364.780.16.1	237	365.772.16.1	241	366.750.16.1	237	367.315.16.1	227
364.782.16.1	254	365.776.16.1	248	366.771.16.1	213	367.320.16.1	227
364.783.00.1	254	365.779.16.3	234	366.772.16.1	241	367.325.16.1	227
364.789.00.1	252	365.780.16.1	237	366.776.16.1	248	367.330.16.1	227
364.812.16.1	251	365.782.16.1	254	366.779.16.3	234	367.335.16.1	227
364.822.00.1	264	365.783.00.1	254	366.780.16.1	237	367.362.16.1	227
364.832.00.2	247	365.784.16.1	236	366.782.16.1	254	367.365.16.1	227
364.841.00.2	246	365.789.00.1	252	366.783.00.1	254	367.370.16.1	227
364.842.00.1	246	365.812.16.1	251	366.784.16.1	236	367.375.16.1	227
364.843.00.2	246	365.813.16.1	245	366.789.00.1	252	367.380.16.1	227
364.850.00.1	137	365.822.00.1	264	366.802.92.1	251	367.385.16.1	227
364.861.00.1	263	365.832.00.2	247	366.812.16.1	251	367.451.16.1	231
364.873.16.1	224	365.841.00.2	246	366.820.92.1	255	367.454.16.1	231
364.874.16.1	224	365.842.00.1	246	366.832.00.2	247	367.471.16.1	237
365.000.16.0	222	365.843.00.2	246	366.841.00.2	246	367.480.16.1	229
365.045.16.1	222	365.850.00.1	137	366.842.00.1	246	367.481.16.1	229
365.055.16.1	223	365.861.00.1	263	366.843.00.2	246	367.485.16.1	244
365.088.16.1	222	366.000.16.0	222	366.850.00.1	250	367.550.16.1	236
365.109.16.1	225	366.045.16.1	222	366.861.00.1	263	367.551.16.1	236

Artikkelnummer	Side	Artikkelnummer	Side	Artikkelnummer	Side	Artikkelnummer	Side
367.558.16.1	229	367.941.16.1	245	369.045.16.1	222	370.587.16.5	230
367.559.16.1	230	367.945.16.1	241	369.055.16.1	223	370.594.16.5	230
367.560.16.1	230	367.988.00.1	252	369.088.16.1	222	370.700.16.1	233
367.561.16.1	229	368.000.16.0	222	369.125.16.1	225	370.701.16.1	233
367.565.16.1	230	368.030.16.1	223	369.130.16.1	225	370.738.16.1	235
367.566.16.1	229	368.045.16.1	222	369.135.16.1	225	370.744.16.1	240
367.570.16.1	230	368.055.16.1	223	369.139.16.1	225	370.745.00.1	240
367.571.16.1	229	368.088.16.1	222	369.145.16.1	225	370.746.00.1	239
367.575.16.1	230	368.120.16.1	225	369.175.16.1	226	370.748.00.1	239
367.576.16.1	229	368.125.16.1	225	369.185.16.1	226	370.751.16.1	247
367.580.16.1	230	368.130.16.1	225	369.189.16.1	226	370.775.16.1	232
367.581.16.1	229	368.135.16.1	225	369.195.16.1	226	370.776.16.1	248
367.600.16.1	228	368.139.16.1	225	369.451.16.1	231	370.812.16.1	251
367.605.16.1	228	368.162.16.1	226	369.454.16.1	231	370.840.00.1	247
367.610.16.1	228	368.165.16.1	226	369.535.16.1	230	370.850.00.1	250
367.614.16.1	232	368.170.16.1	226	369.550.16.1	236	370.861.26.1	263
367.615.16.1	224	368.175.16.1	226	369.551.16.1	236	371.000.16.0	222
367.616.16.1	224	368.180.16.1	226	369.584.16.1	230	371.015.16.1	223
367.700.16.1	233	368.185.16.1	226	369.586.16.1	229	371.030.16.1	223
367.701.16.1	233	368.189.16.1	226	369.587.16.1	230	371.045.16.1	223
367.730.16.1	245	368.285.16.1	228	369.588.16.1	229	371.055.16.1	223
367.740.16.1	237	368.451.16.1	231	369.591.16.1	229	371.135.16.1	225
367.742.00.1	253	368.454.16.1	231	369.700.16.1	233	371.139.16.1	225
367.744.16.1	240	368.550.16.1	236	369.701.16.1	233	371.145.16.1	225
367.745.00.1	240	368.561.16.1	229	369.742.00.1	253	371.146.16.1	225
367.746.00.1	239	368.566.16.1	229	369.743.26.1	240	371.147.16.1	225
367.750.16.1	237	368.571.16.1	229	369.744.16.1	240	371.185.16.1	226
367.771.16.1	213	368.575.16.1	230	369.745.00.1	240	371.189.16.1	226
367.772.16.1	241	368.576.16.1	229	369.746.00.1	239	371.195.16.1	226
367.776.16.1	248	368.580.16.1	230	369.748.00.1	239	371.196.16.1	227
367.779.16.3	234	368.581.16.1	229	369.771.16.1	213	371.454.16.1	231
367.780.16.1	237	368.584.16.1	230	369.776.16.1	248	371.550.16.1	236
367.782.16.1	254	368.585.16.1	230	369.779.16.3	234	371.596.16.1	230
367.784.16.1	236	368.586.16.1	229	369.802.92.1	251	371.700.16.1	233
367.789.00.1	252	368.605.16.1	228	369.812.16.1	251	371.701.16.1	233
367.792.16.1	242	368.700.16.1	233	369.832.00.2	247	371.738.16.1	235
367.794.16.1	245	368.701.16.1	233	369.841.00.2	246	371.743.26.1	240
367.802.92.1	251	368.742.00.1	253	369.842.00.1	246	371.744.16.1	240
367.809.16.1	251	368.744.16.1	240	369.850.00.1	250	371.745.00.1	240
367.810.16.1	251	368.745.00.1	240	369.861.00.1	263	371.746.00.1	239
367.812.16.1	251	368.746.00.1	239	370.000.16.0	222	371.748.00.1	239
367.813.16.1	245	368.748.00.1	239	370.015.16.1	223	371.751.16.1	247
367.832.00.2	247	368.771.16.1	232	370.030.16.1	223	371.775.16.1	232
367.841.00.2	246	368.776.16.1	248	370.045.16.1	222	371.776.16.1	248
367.842.00.1	246	368.779.16.3	234	370.055.16.1	223	371.840.00.1	247
367.843.00.2	246	368.789.00.1	252	370.135.16.1	225	371.841.00.1	247
367.850.00.1	250	368.812.16.1	251	370.139.16.1	225	372.000.16.0	222
367.861.00.1	263	368.832.00.2	247	370.145.16.1	225	372.015.16.1	223
367.868.16.1	244	368.841.00.2	246	370.146.16.1	225	372.030.16.1	223
367.876.16.1	224	368.842.00.1	246	370.185.16.1	226	372.045.16.1	223
367.887.16.1	245	368.843.00.2	246	370.189.16.1	226	372.055.16.1	223
367.913.16.1	242	368.850.00.1	250	370.195.16.1	226	372.135.16.1	225
367.914.16.1	243	368.861.00.1	263	370.196.16.1	226	372.139.16.1	225
367.923.16.1	243	369.000.16.0	222	370.454.16.1	231	372.145.16.1	225
367.925.16.1	242	369.015.16.1	223	370.550.16.1	236	372.146.16.1	225
367.928.16.1	231	369.030.16.1	223	370.584.16.5	230	372.147.16.1	225



Artikkelnummer	Side	Artikkelnummer	Side	Artikkelnummer	Side	Artikkelnummer	Side
372.148.16.1	225	390.080.14.1	201	390.283.14.1	200	390.433.14.1	192
372.185.16.1	227	390.083.14.1	200	390.284.14.1	200	390.434.14.1	192
372.189.16.1	227	390.099.26.1	202	390.286.14.1	200	390.448.14.1	193
372.195.16.1	227	390.100.14.1	190	390.287.14.1	200	390.449.14.1	193
372.196.16.1	227	390.101.14.1	190	390.289.14.1	201	390.454.14.1	192
372.197.16.1	227	390.102.14.1	190	390.295.14.1	199	390.457.14.1	195
372.198.16.1	227	390.104.14.1	190	390.296.14.1	185	390.459.14.1	194
372.454.16.1	231	390.105.14.1	190	390.299.26.1	202	390.462.14.1	194
372.550.16.1	236	390.106.14.1	190	390.300.14.1	190	390.463.14.1	195
372.596.16.1	230	390.107.14.1	190	390.301.14.1	190	390.464.14.1	194
372.598.16.1	230	390.108.14.1	198	390.302.14.1	190	390.466.14.1	193
372.700.16.1	233	390.116.14.1	198	390.304.14.1	190	390.469.14.1	192
372.701.16.1	233	390.117.14.1	198	390.305.14.1	190	390.470.14.1	194
372.738.16.1	235	390.118.14.1	197	390.306.14.1	190	390.471.14.1	196
372.743.26.1	240	390.120.14.1	191	390.307.14.1	190	390.472.14.1	196
372.744.16.1	240	390.121.14.1	191	390.308.14.1	184	390.473.14.1	196
372.745.00.1	240	390.122.14.1	191	390.316.14.1	198	390.474.14.1	195
372.746.00.1	239	390.123.14.1	191	390.317.14.1	198	390.475.14.1	195
372.748.00.1	239	390.124.14.1	191	390.318.14.1	197	390.493.11.1	201
372.751.16.1	247	390.128.14.1	202	390.320.14.1	191	390.495.14.1	199
372.775.16.1	232	390.130.14.1	192	390.321.14.1	191	390.496.14.1	185
372.776.16.1	248	390.131.14.1	192	390.322.14.1	191	390.499.26.1	202
372.840.00.1	247	390.147.14.1	193	390.323.14.1	191	390.500.14.1	190
372.841.00.1	247	390.179.14.1	196	390.324.14.1	191	390.501.14.1	190
372.850.00.1	250	390.180.14.1	201	390.327.14.1	197	390.502.14.1	190
379.000.16.0	222	390.183.14.1	200	390.328.14.1	186	390.503.14.1	197
379.055.16.1	223	390.186.14.1	200	390.331.14.1	192	390.504.14.1	190
379.108.16.1	225	390.199.26.1	202	390.332.14.1	192	390.505.14.1	190
379.158.16.1	227	390.200.14.1	190	390.333.14.1	192	390.506.14.1	190
379.740.16.1	237	390.201.14.1	190	390.347.14.1	193	390.507.14.1	191
379.750.16.1	237	390.202.14.1	190	390.348.14.1	193	390.508.14.1	185
379.772.16.1	241	390.203.14.1	184	390.349.14.1	193	390.516.14.1	198
379.780.16.1	237	390.204.14.1	190	390.372.14.1	196	390.517.14.1	198
379.782.16.1	254	390.205.14.1	190	390.373.14.1	195	390.518.14.1	197
379.791.16.1	233	390.206.14.1	190	390.395.14.1	199	390.520.14.1	191
387.282.00.1	253	390.207.14.1	190	390.396.14.1	185	390.521.14.1	191
388.126.00.1	137	390.216.14.1	198	390.399.26.1	202	390.522.14.1	191
388.127.00.1	137	390.217.14.1	198	390.400.14.1	190	390.523.14.1	191
388.128.00.1	137	390.218.14.1	197	390.401.14.1	190	390.524.14.1	191
390.000.14.1	190	390.220.14.1	191	390.402.14.1	190	390.527.14.1	197
390.001.14.1	190	390.221.14.1	191	390.404.14.1	190	390.528.14.1	186
390.002.14.1	190	390.222.14.1	191	390.405.14.1	190	390.531.14.1	192
390.004.14.1	190	390.223.14.1	191	390.406.14.1	190	390.532.14.1	192
390.005.14.1	190	390.224.14.1	191	390.407.14.1	191	390.533.14.1	192
390.006.14.1	190	390.225.14.1	196	390.408.14.1	184	390.534.14.1	192
390.007.14.1	190	390.227.14.1	197	390.416.14.1	198	390.535.14.1	192
390.008.14.1	198	390.228.14.1	186	390.417.14.1	198	390.547.14.1	193
390.016.14.1	198	390.230.14.1	192	390.418.14.1	197	390.548.14.1	193
390.017.14.1	198	390.231.14.1	192	390.420.14.1	191	390.549.14.1	193
390.020.14.1	191	390.232.14.1	192	390.421.14.1	191	390.554.14.1	192
390.021.14.1	191	390.247.14.1	193	390.422.14.1	191	390.555.14.1	192
390.022.14.1	191	390.248.14.1	193	390.423.14.1	191	390.557.14.1	195
390.023.14.1	191	390.271.14.1	196	390.424.14.1	191	390.559.14.1	194
390.024.14.1	191	390.278.14.1	196	390.427.14.1	197	390.560.14.1	194
390.030.14.1	192	390.279.14.1	196	390.428.14.1	186	390.561.14.1	194
390.046.14.1	193	390.281.14.1	201	390.432.14.1	192	390.562.14.1	194

Artikkelnummer	Side	Artikkelnummer	Side	Artikkelnummer	Side	Artikkelnummer	Side
390.563.14.1	195	390.705.14.1	190	393.322.14.1	177	393.506.14.1	176
390.564.14.1	194	390.706.14.1	190	393.323.14.1	177	393.507.14.1	176
390.565.14.1	194	390.707.14.1	191	393.324.14.1	177	393.516.14.1	184
390.566.14.1	193	390.708.14.1	185	393.327.14.1	182	393.517.14.1	184
390.567.14.1	193	390.716.14.1	198	393.332.14.1	178	393.518.14.1	184
390.569.14.1	192	390.717.14.1	198	393.333.14.1	178	393.520.14.1	177
390.570.14.1	194	390.718.14.1	197	393.348.14.1	178	393.521.14.1	177
390.571.14.1	196	390.720.14.1	191	393.349.14.1	178	393.522.14.1	177
390.572.14.1	196	390.721.14.1	191	393.372.14.1	181	393.523.14.1	177
390.573.14.1	196	390.722.14.1	191	393.399.26.1	185	393.524.14.1	177
390.574.14.1	196	390.723.14.1	191	393.400.14.1	176	393.525.14.1	182
390.575.14.1	195	390.724.14.1	191	393.401.14.1	176	393.526.14.1	183
390.576.14.1	195	390.727.14.1	197	393.402.14.1	176	393.527.14.1	182
390.577.14.1	195	390.728.14.1	186	393.404.14.1	176	393.532.14.1	178
390.578.14.1	194	390.735.14.1	192	393.405.14.1	176	393.533.14.1	178
390.592.11.1	201	390.736.14.1	192	393.406.14.1	176	393.534.14.1	178
390.593.11.1	201	390.737.14.1	192	393.407.14.1	176	393.535.14.1	178
390.595.14.1	199	390.751.14.1	193	393.416.14.1	184	393.540.14.1	183
390.596.14.1	185	390.752.14.1	193	393.417.14.1	184	393.541.14.1	183
390.599.26.1	202	390.753.14.1	193	393.418.14.1	184	393.542.14.1	183
390.600.14.1	190	390.775.14.1	196	393.420.14.1	177	393.543.14.1	183
390.601.14.1	190	390.776.14.1	196	393.421.14.1	177	393.544.14.1	183
390.602.14.1	190	390.796.14.1	185	393.422.14.1	177	393.545.14.1	183
390.603.14.1	197	390.798.26.1	202	393.423.14.1	177	393.546.14.1	183
390.604.14.1	190	390.799.26.1	202	393.424.14.1	177	393.547.14.1	178
390.605.14.1	190	393.200.14.1	176	393.425.14.1	182	393.549.14.1	178
390.606.14.1	190	393.201.14.1	176	393.426.14.1	183	393.550.14.1	180
390.607.14.1	191	393.202.14.1	176	393.427.14.1	182	393.551.14.1	180
390.608.14.1	185	393.204.14.1	176	393.432.14.1	178	393.552.14.1	179
390.616.14.1	198	393.205.14.1	176	393.433.14.1	178	393.553.14.1	180
390.617.14.1	198	393.206.14.1	176	393.434.14.1	178	393.554.14.1	180
390.618.14.1	197	393.207.14.1	176	393.440.14.1	183	393.555.14.1	179
390.620.14.1	191	393.216.14.1	184	393.442.14.1	183	393.556.14.1	179
390.621.14.1	191	393.217.14.1	184	393.444.14.1	183	393.557.14.1	180
390.622.14.1	191	393.218.14.1	184	393.445.14.1	183	393.558.14.1	179
390.623.14.1	191	393.220.14.1	177	393.446.14.1	183	393.559.14.1	180
390.624.14.1	191	393.221.14.1	177	393.448.14.1	178	393.560.14.1	181
390.627.14.1	197	393.222.14.1	177	393.449.14.1	178	393.561.14.1	181
390.628.14.1	186	393.223.14.1	177	393.454.14.1	179	393.562.14.1	181
390.634.14.1	192	393.224.14.1	177	393.456.14.1	179	393.563.14.1	180
390.635.14.1	192	393.227.14.1	182	393.457.14.1	180	393.564.14.1	180
390.636.14.1	192	393.232.14.1	178	393.459.14.1	180	393.565.14.1	181
390.650.14.1	193	393.248.14.1	178	393.462.14.1	181	393.566.14.1	179
390.651.14.1	193	393.299.26.1	185	393.463.14.1	180	393.570.14.1	181
390.652.14.1	193	393.300.14.1	176	393.464.14.1	180	393.572.14.1	181
390.662.14.1	194	393.301.14.1	176	393.466.14.1	179	393.573.14.1	181
390.665.14.1	193	393.302.14.1	176	393.470.14.1	181	393.574.14.1	181
390.675.14.1	196	393.304.14.1	176	393.472.14.1	181	393.578.14.1	181
390.695.14.1	199	393.305.14.1	176	393.473.14.1	181	393.599.26.1	185
390.696.14.1	185	393.306.14.1	176	393.499.26.1	185	393.600.14.1	176
390.699.26.1	202	393.307.14.1	176	393.500.14.1	176	393.601.14.1	176
390.700.14.1	190	393.316.14.1	184	393.501.14.1	176	393.602.14.1	176
390.701.14.1	190	393.317.14.1	184	393.502.14.1	176	393.603.14.1	182
390.702.14.1	190	393.318.14.1	184	393.503.14.1	182	393.604.14.1	176
390.703.14.1	197	393.320.14.1	177	393.504.14.1	176	393.605.14.1	176
390.704.14.1	190	393.321.14.1	177	393.505.14.1	176	393.606.14.1	176



Artikkelnummer	Side	Artikkelnummer	Side	Artikkelnummer	Side	Artikkelnummer	Side
393.607.14.1	176	600.090.00.1	31	602.294.00.5	135	604.020.00.2	162
393.616.14.1	184	600.091.00.1	31	602.296.00.5	135	604.100.00.1	124
393.617.14.1	184	600.092.00.1	31	602.360.00.5	128	604.100.00.2	124
393.620.14.1	177	600.093.00.1	31	602.422.00.1	135	604.254.00.5	131
393.621.14.1	177	600.094.00.1	31	602.423.00.1	135	604.258.00.5	132
393.622.14.1	177	600.101.00.2	45	602.485.00.1	309	604.360.00.5	128
393.624.14.1	177	601.020.00.2	162	602.507.00.5	19	604.362.00.5	128
393.627.14.1	182	601.100.00.1	124	602.508.00.5	19	604.363.00.5	128
393.633.14.1	178	601.100.00.2	124	602.509.00.5	19	604.485.00.1	309
393.634.14.1	178	601.130.00.1	124	602.535.00.5	130	604.508.00.5	19
393.635.14.1	178	601.130.00.2	124	602.536.00.5	130	604.537.00.5	130
393.636.14.1	178	601.136.00.1	125	602.555.00.5	131	604.538.00.5	130
393.650.14.1	178	601.252.00.5	131	602.556.00.5	131	604.557.00.5	131
393.651.14.1	179	601.253.00.5	131	602.571.00.5	132	604.558.00.5	131
393.652.14.1	178	601.256.00.5	132	602.575.00.5	125	604.571.00.5	132
393.654.14.1	178	601.257.00.5	132	602.581.00.5	133	604.575.00.5	125
393.662.14.1	180	601.273.00.5	135	602.582.00.5	133	604.581.00.5	133
393.665.14.1	179	601.289.00.5	135	602.583.00.5	133	604.583.00.5	133
393.674.14.1	181	601.293.00.5	135	602.584.00.5	133	604.584.00.5	133
393.675.14.1	181	601.296.00.5	135	602.585.00.5	133	604.585.00.5	133
393.699.26.1	186	601.360.00.5	128	602.586.00.5	133	604.586.00.5	133
393.700.14.1	176	601.485.00.1	309	602.590.00.5	132	604.590.00.5	132
393.701.14.1	176	601.507.00.5	19	602.591.00.5	132	604.591.00.5	132
393.702.14.1	176	601.508.00.5	19	602.595.00.5	133	604.595.00.5	133
393.703.14.1	182	601.535.00.5	130	602.623.00.5	136	604.596.00.5	133
393.704.14.1	176	601.536.00.5	130	602.811.00.1	137	604.702.00.1	137
393.705.14.1	176	601.555.00.5	131	603.020.00.2	162	605.020.00.2	162
393.706.14.1	176	601.556.00.5	131	603.023.00.2	163	605.100.00.1	124
393.707.14.1	176	601.571.00.5	132	603.100.00.1	124	605.100.00.2	124
393.716.14.1	184	601.575.00.5	125	603.100.00.2	124	605.255.00.5	131
393.717.14.1	184	601.579.00.5	133	603.110.00.1	124	605.259.00.5	132
393.720.14.1	177	601.582.00.5	133	603.136.00.1	125	605.360.00.5	128
393.721.14.1	177	601.583.00.5	133	603.253.00.5	131	605.362.00.5	128
393.722.14.1	177	601.584.00.5	133	603.254.00.5	131	605.363.00.5	128
393.724.14.1	177	601.590.00.5	132	603.257.00.5	132	605.364.00.5	128
393.727.14.1	182	601.595.00.5	133	603.258.00.5	132	605.485.00.1	309
393.734.14.1	178	601.623.00.5	136	603.360.00.5	128	605.508.00.5	19
393.735.14.1	178	601.811.00.1	137	603.362.00.5	128	605.537.00.5	130
393.736.14.1	178	601.813.00.1	28	603.485.00.1	309	605.538.00.5	130
393.737.14.1	178	601.815.00.1	28	603.508.00.5	19	605.539.00.5	130
393.751.14.1	178	602.020.00.2	162	603.535.00.5	130	605.557.00.5	131
393.752.14.1	178	602.023.00.2	163	603.536.00.5	130	605.558.00.5	131
393.753.14.1	178	602.100.00.1	124	603.537.00.5	130	605.559.00.5	131
393.775.14.1	181	602.100.00.2	124	603.556.00.5	131	605.571.00.5	132
393.776.14.1	181	602.130.00.1	124	603.557.00.5	131	605.575.00.5	125
393.799.26.1	186	602.130.00.2	124	603.571.00.5	132	605.581.00.5	133
600.079.00.1	31	602.136.00.1	125	603.575.00.5	125	605.585.00.5	133
600.080.00.1	31	602.252.00.5	131	603.582.00.5	133	605.589.00.5	133
600.081.00.1	31	602.253.00.5	131	603.583.00.5	133	605.590.00.5	132
600.082.00.1	31	602.256.00.5	132	603.584.00.5	133	605.591.00.5	132
600.083.00.1	31	602.257.00.5	132	603.585.00.5	133	605.595.00.5	133
600.084.00.1	31	602.273.00.5	135	603.586.00.5	133	605.596.00.5	133
600.085.00.1	31	602.274.00.5	135	603.590.00.5	132	605.702.00.1	137
600.087.00.1	31	602.275.00.5	135	603.595.00.5	133	606.020.00.2	162
600.088.00.1	31	602.289.00.5	135	603.702.00.1	137	606.100.00.1	124
600.089.00.1	31	602.293.00.5	135	603.811.00.1	137	606.100.00.2	124

Artikkelnummer	Side	Artikkelnummer	Side	Artikkelnummer	Side	Artikkelnummer	Side
606.255.00.5	131	615.061.00.2	162	620.011.00.1	143	620.095.00.1	129
606.256.00.5	132	616.061.00.2	162	620.012.00.1	143	620.096.00.1	129
606.360.00.5	128	616.222.11.1	168	620.013.00.1	143	620.097.00.1	129
606.361.00.5	128	616.222.21.1	168	620.014.00.1	143	620.100.00.1	146
606.362.00.5	128	616.222.46.1	168	620.015.00.1	143	620.101.00.1	146
606.363.00.5	128	616.290.00.1	168	620.016.00.1	143	620.102.00.1	146
606.485.00.1	309	616.291.00.1	168	620.017.00.1	143	620.103.00.1	146
606.508.00.5	19	619.010.00.1	142	620.020.00.1	144	620.104.00.1	146
606.537.00.5	130	619.011.00.1	142	620.021.00.1	144	620.105.00.1	146
606.540.00.5	130	619.012.00.1	142	620.022.00.1	144	620.106.00.1	146
606.559.00.5	131	619.013.00.1	142	620.023.00.1	144	620.107.00.1	146
606.560.00.5	131	619.014.00.1	142	620.024.00.1	144	620.108.00.1	146
606.571.00.5	132	619.015.00.1	142	620.025.00.1	144	620.111.00.1	146
606.575.00.5	125	619.016.00.1	142	620.031.00.1	144	620.112.00.1	146
606.580.00.5	133	619.020.00.1	142	620.032.00.1	144	620.113.00.1	146
606.581.00.5	133	619.021.00.1	142	620.033.00.1	144	620.114.00.1	146
606.585.00.5	133	619.022.00.1	142	620.034.00.1	144	620.115.00.1	146
606.590.00.5	132	619.023.00.1	142	620.035.00.1	144	620.116.00.1	146
606.591.00.5	132	619.024.00.1	142	620.036.00.1	144	620.117.00.1	146
606.595.00.5	133	619.025.00.1	142	620.037.00.1	144	620.121.00.1	146
606.702.00.1	137	619.026.00.1	142	620.042.00.1	144	620.122.00.1	146
607.100.00.1	124	619.027.00.1	142	620.043.00.1	144	620.123.00.1	146
607.100.00.2	124	619.050.00.1	142	620.044.00.1	144	620.124.00.1	146
607.255.00.5	131	619.051.00.1	142	620.045.00.1	144	620.125.00.1	146
607.256.00.5	132	619.052.00.1	142	620.046.00.1	144	620.126.00.1	146
607.360.00.5	128	619.060.00.1	142	620.047.00.1	144	620.127.00.1	146
607.363.00.5	128	619.061.00.1	142	620.054.00.1	144	620.131.00.1	146
607.366.00.5	128	619.140.00.1	143	620.057.00.1	144	620.132.00.1	146
607.485.00.1	309	619.141.00.1	143	620.061.00.1	145	620.133.00.1	146
607.508.00.5	19	619.142.00.1	143	620.062.00.1	145	620.135.00.1	146
607.539.00.5	130	619.220.00.1	143	620.063.00.1	145	620.136.00.1	146
607.541.00.5	130	619.221.00.1	143	620.064.00.1	145	620.137.00.1	146
607.560.00.5	131	619.616.00.1	155	620.065.00.1	145	620.142.00.1	146
607.561.00.5	131	619.617.00.1	155	620.066.00.1	145	620.143.00.1	146
607.571.00.5	132	619.700.00.1	150	620.067.00.1	145	620.147.00.1	146
607.581.00.5	133	619.701.00.1	150	620.070.00.1	145	620.150.00.1	146
607.587.00.5	133	619.702.00.1	150	620.071.00.1	145	620.151.00.1	146
607.590.00.5	132	619.703.00.1	150	620.072.00.1	145	620.152.00.1	146
607.595.00.5	133	619.704.00.1	150	620.073.00.1	145	620.153.00.1	146
607.702.00.1	137	619.705.00.1	150	620.074.00.1	145	620.154.00.1	146
608.100.00.1	124	619.706.00.1	150	620.075.00.1	145	620.155.00.1	146
608.363.00.5	128	619.730.00.1	157	620.076.00.1	145	620.156.00.1	147
608.520.00.5	134	619.731.00.1	157	620.077.00.1	145	620.157.00.1	146
608.541.00.5	130	619.732.00.1	157	620.080.00.1	145	620.162.00.1	146
608.561.00.5	131	619.733.00.1	157	620.081.00.1	145	620.163.00.1	146
608.702.00.1	137	619.734.00.1	157	620.082.00.1	145	620.164.00.1	146
611.061.00.2	162	619.735.00.1	157	620.083.00.1	145	620.165.00.1	147
611.582.22.5	136	619.736.00.1	157	620.084.00.1	145	620.166.00.1	147
612.061.00.2	162	619.737.00.1	157	620.085.00.1	145	620.173.00.1	146
612.535.22.5	136	619.850.00.1	162	620.086.00.1	145	620.174.00.1	146
612.536.22.5	136	619.851.00.1	162	620.087.00.1	145	620.175.00.1	147
612.582.22.5	136	619.852.00.1	162	620.090.00.1	129	620.176.00.1	147
613.061.00.2	162	619.853.00.1	162	620.091.00.1	129	620.177.00.1	147
613.536.22.5	136	619.854.00.1	162	620.092.00.1	129	620.184.00.1	146
613.583.22.5	136	619.855.00.1	162	620.093.00.1	129	620.185.00.1	147
614.061.00.2	162	620.010.00.1	143	620.094.00.1	129	620.230.00.1	18



Artikkelnummer	Side	Artikkelnummer	Side	Artikkelnummer	Side	Artikkelnummer	Side
620.231.00.1	18	620.406.00.1	150	620.595.00.1	152	620.688.00.1	153
620.232.00.1	18	620.407.00.1	150	620.596.00.1	152	620.689.00.1	153
620.233.00.1	18	620.410.00.1	150	620.600.00.1	152	620.690.00.1	154
620.234.00.1	18	620.411.00.1	150	620.601.00.1	152	620.691.00.1	154
620.235.00.1	18	620.412.00.1	150	620.602.00.1	152	620.693.00.1	153
620.236.00.1	18	620.413.00.1	150	620.603.00.1	152	620.694.00.1	153
620.240.00.1	18	620.414.00.1	150	620.604.00.1	152	620.695.00.1	153
620.241.00.1	18	620.415.00.1	150	620.605.00.1	152	620.700.00.1	154
620.242.00.1	18	620.416.00.1	150	620.606.00.1	152	620.701.00.1	154
620.250.00.1	46	620.420.00.1	150	620.613.00.1	152	620.710.00.1	154
620.252.00.1	46	620.421.00.1	150	620.614.00.1	152	620.720.00.1	154
620.253.00.1	46	620.424.00.1	150	620.615.00.1	152	620.721.00.1	154
620.254.00.1	46	620.502.00.1	151	620.620.00.1	153	620.722.00.1	154
620.255.00.1	46	620.503.00.1	151	620.621.00.1	153	620.730.00.1	154
620.256.00.1	46	620.504.00.1	151	620.622.00.1	153	620.731.00.1	154
620.257.00.1	46	620.505.00.1	151	620.623.00.1	153	620.732.00.1	154
620.300.00.1	149	620.506.00.1	151	620.624.00.1	153	620.740.00.1	155
620.301.00.1	149	620.510.00.1	151	620.625.00.1	153	620.741.00.1	155
620.302.00.1	149	620.511.00.1	151	620.626.00.1	153	620.742.00.1	155
620.303.00.1	149	620.512.00.1	151	620.630.00.1	153	620.750.00.1	156
620.304.00.1	149	620.520.00.1	151	620.631.00.1	153	620.760.00.1	156
620.305.00.1	149	620.521.00.1	151	620.632.00.1	153	620.761.00.1	156
620.306.00.1	149	620.522.00.1	151	620.633.00.1	153	620.770.00.1	156
620.307.00.1	149	620.523.00.1	151	620.634.00.1	153	620.771.00.1	156
620.308.00.1	149	620.524.00.1	151	620.635.00.1	153	620.802.00.1	156
620.309.00.1	149	620.525.00.1	151	620.636.00.1	153	620.810.00.1	156
620.310.00.1	149	620.526.00.1	151	620.640.00.1	153	620.811.00.1	156
620.311.00.1	149	620.527.00.1	151	620.641.00.1	153	620.821.00.1	156
620.312.00.1	149	620.528.00.1	151	620.642.00.1	153	621.000.00.5	134
620.313.00.1	149	620.532.00.1	151	620.643.00.1	153	621.271.00.5	126
620.314.00.1	149	620.533.00.1	151	620.644.00.1	153	621.310.00.5	127
620.315.00.1	149	620.534.00.1	151	620.645.00.1	153	621.505.00.5	125
620.316.00.1	149	620.535.00.1	151	620.646.00.1	153	622.000.00.5	134
620.320.00.1	149	620.536.00.1	151	620.650.00.1	153	622.271.00.5	126
620.321.00.1	149	620.540.00.1	151	620.651.00.1	153	622.310.00.5	127
620.322.00.1	149	620.541.00.1	151	620.652.00.1	153	622.311.00.5	127
620.324.00.1	149	620.542.00.1	151	620.653.00.1	153	622.312.00.5	127
620.329.00.1	46	620.550.00.1	151	620.654.00.1	153	622.313.00.5	127
620.332.00.1	46	620.551.00.1	151	620.655.00.1	153	622.314.00.5	127
620.333.00.1	46	620.570.00.1	152	620.656.00.1	153	622.505.00.5	125
620.334.00.1	46	620.571.00.1	152	620.661.00.1	153	622.535.00.5	130
620.335.00.1	46	620.572.00.1	152	620.662.00.1	153	622.650.00.5	126
620.336.00.1	46	620.573.00.1	152	620.663.00.1	153	623.000.00.5	134
620.337.00.1	46	620.574.00.1	152	620.664.00.1	153	623.245.00.5	126
620.338.00.1	46	620.575.00.1	152	620.665.00.1	153	623.271.00.5	126
620.339.00.1	46	620.576.00.1	152	620.671.00.1	153	623.310.00.5	127
620.347.00.1	46	620.580.00.1	152	620.672.00.1	153	623.311.00.5	127
620.353.00.1	147	620.581.00.1	152	620.673.00.1	153	623.315.00.5	127
620.354.00.1	147	620.582.00.1	152	620.674.00.1	153	623.316.00.5	127
620.355.00.1	147	620.583.00.1	152	620.675.00.1	153	623.317.00.5	127
620.400.00.1	150	620.584.00.1	152	620.680.00.1	154	623.318.00.5	127
620.401.00.1	150	620.585.00.1	152	620.681.00.1	154	623.505.00.5	125
620.402.00.1	150	620.586.00.1	152	620.683.00.1	154	623.536.00.5	130
620.403.00.1	150	620.591.00.1	152	620.684.00.1	154	623.650.00.5	126
620.404.00.1	150	620.593.00.1	152	620.685.00.1	153	623.651.00.5	126
620.405.00.1	150	620.594.00.1	152	620.686.00.1	153	624.245.00.5	126

Artikkelnummer	Side	Artikkelnummer	Side	Artikkelnummer	Side	Artikkelnummer	Side
624.271.00.5	126	628.655.00.5	126	690.321.00.1	288	691.189.00.1	290
624.310.00.5	127	650.921.00.2	298	690.322.00.1	288	691.203.00.1	289
624.311.00.5	127	653.940.26.1	300	690.323.00.1	288	691.214.P2.1	282
624.314.00.5	127	654.940.26.1	300	690.324.00.1	288	691.218.P1.2	281
624.316.00.5	127	655.078.00.1	296	690.412.00.3	299	691.229.P1.2	283
624.317.00.5	127	655.079.00.1	297	690.467.00.2	305	691.231.P1.1	284
624.319.00.5	127	655.081.00.1	301	690.474.00.1	303	691.296.00.2	289
624.505.00.5	125	655.082.00.1	301	690.475.00.1	303	853.524.00.1	252
624.537.00.5	130	655.083.00.1	301	690.476.00.1	303	953.761.00.1	187
624.651.00.5	126	655.084.00.1	297	690.486.00.4	303		
624.652.00.5	126	655.104.00.1	301	690.511.P2.1	282		
625.245.00.5	126	655.940.26.1	300	690.512.00.2	281		
625.271.00.5	126	656.940.26.1	300	690.514.00.2	283		
625.310.00.5	127	657.940.26.1	300	690.589.00.1	281		
625.317.00.5	127	658.940.26.1	300	690.598.P1.1	282		
625.319.00.5	127	659.940.26.1	300	690.598.P1.2	282		
625.321.00.5	127	661.535.00.5	130	690.600.00.1	281		
625.505.00.5	125	662.535.00.5	130	690.912.00.1	300		
625.538.00.5	130	663.536.00.5	130	690.913.00.1	300		
625.651.00.5	126	664.537.00.5	130	690.915.00.1	300		
625.652.00.5	126	665.538.00.5	130	690.916.00.1	300		
625.653.00.5	126	666.537.00.5	130	690.917.00.1	300		
626.245.00.5	126	667.539.00.5	130	690.918.00.1	300		
626.271.00.5	126	690.017.00.1	280	690.920.00.1	307		
626.310.00.5	127	690.019.00.1	280	690.921.00.1	308		
626.317.00.5	127	690.102.00.1	187	690.922.00.1	308		
626.319.00.5	127	690.103.00.1	187	690.923.00.1	308		
626.320.00.5	127	690.111.00.1	299	690.924.00.1	308		
626.321.00.5	127	690.112.00.1	298	690.925.00.1	308		
626.505.00.5	125	690.115.00.1	298	690.926.00.1	308		
626.537.00.5	130	690.134.00.1	306	690.927.00.1	308		
626.652.00.5	126	690.140.00.1	304	690.936.00.1	298		
626.653.00.5	126	690.141.00.1	304	690.940.00.1	301		
627.245.00.5	126	690.142.00.1	304	690.941.00.1	301		
627.271.00.5	126	690.143.00.1	304	690.942.00.1	158		
627.310.00.5	127	690.144.00.1	304	691.017.P1.1	280		
627.316.00.5	127	690.182.00.1	304	691.030.00.1	296		
627.320.00.5	127	690.211.00.1	307	691.031.00.1	296		
627.321.00.5	127	690.212.00.1	307	691.032.00.1	297		
627.322.00.5	127	690.214.00.1	307	691.033.00.1	298		
627.505.00.5	125	690.221.00.1	288	691.034.00.1	298		
627.539.00.5	130	690.222.00.1	288	691.035.00.1	296		
627.653.00.5	126	690.223.00.1	288	691.036.00.1	297		
627.654.00.5	126	690.224.00.1	288	691.037.00.1	297		
628.245.00.5	126	690.225.00.1	288	691.103.P2.1	283		
628.271.00.5	126	690.226.00.1	288	691.113.P2.1	283		
628.310.00.5	127	690.230.00.1	288	691.137.00.1	289		
628.316.00.5	127	690.240.00.1	305	691.152.00.1	301		
628.320.00.5	127	690.241.00.1	305	691.170.00.1	306		
628.321.00.5	127	690.242.00.1	305	691.171.00.1	306		
628.322.00.5	127	690.243.00.1	305	691.181.00.1	289		
628.323.00.5	127	690.244.00.1	305	691.182.00.1	289		
628.505.00.5	125	690.245.00.1	305	691.183.00.1	289		
628.541.00.5	130	690.253.00.1	304	691.186.00.1	290		
628.653.00.5	126	690.300.00.1	299	691.187.00.1	291		
628.654.00.5	126	690.301.00.1	299	691.188.00.1	290		



NRF nr

NRF nr.	Side	NRF nr.	Side	NRF nr.	Side	NRF nr.	Side
1080001	10	1082152	22	1082349	26	1082599	20
1080002	10	1082153	22	1082351	88	1082601	20
1080003	10	1082154	22	1082352	88	1082603	20
1080004	10	1082155	22	1082353	88	1082604	20
1080005	10	1082186	14	1082358	13	1082605	20
1080006	10	1082189	14	1082359	13	1082606	20
1080026	10	1082193	14	1082363	13	1082607	20
1080029	10	1082196	14	1082366	13	1082609	20
1080032	10	1082199	14	1082369	13	1082611	20
1080033	10	1082203	14	1082373	13	1082613	20
1080034	10	1082206	14	1082376	13	1082616	20
1080036	11	1082209	14	1082379	13	1082617	20
1080037	11	1082212	14	1082382	13	1082618	20
1080038	11	1082213	14	1082383	13	1082619	20
1080039	11	1082214	14	1082384	13	1082636	21
1080041	11	1082226	22	1082408	14	1082637	21
1080042	11	1082229	22	1082409	14	1082638	21
1080043	11	1082233	22	1082413	14	1082639	21
1080044	11	1082236	22	1082416	14	1082641	21
1080056	10	1082239	22	1082419	14	1082643	21
1080059	10	1082243	22	1082423	14	1082646	21
1080063	10	1082246	22	1082426	14	1082647	21
1080066	10	1082249	22	1082429	14	1082649	21
1080069	10	1082253	22	1082432	14	1082651	21
1080073	10	1082264	22	1082433	14	1082653	21
1080076	10	1082266	22	1082434	14	1082656	21
1080079	10	1082267	22	1082506	11	1082657	21
1081159	19	1082291	21	1082509	11	1082659	21
1081163	19	1082292	21	1082513	11	1082661	21
1081166	19	1082306	14	1082516	11	1082664	21
1081169	19	1082309	14	1082519	11	1082666	21
1081173	19	1082313	14	1082523	11	1082676	21
1081176	19	1082316	14	1082526	11	1082679	21
1081179	19	1082319	14	1082529	11	1082681	21
1081187	19	1082323	14	1082532	11	1082683	21
1081188	19	1082326	14	1082533	11	1082686	21
1081189	19	1082329	14	1082534	11	1082689	21
1082116	13	1082331	25	1082546	12	1082693	21
1082119	13	1082332	25	1082549	12	1082756	12
1082123	13	1082333	25	1082553	12	1082759	12
1082126	13	1082334	25	1082556	12	1082763	12
1082129	13	1082335	25	1082559	12	1082766	12
1082133	13	1082336	25	1082563	12	1082769	12
1082136	13	1082337	25	1082566	12	1082772	12
1082139	13	1082338	25	1082569	12	1082773	12
1082142	13	1082339	26	1082572	12	1082776	12
1082143	13	1082341	26	1082573	12	1082779	12
1082144	13	1082342	26	1082574	12	1082783	12
1082145	22	1082343	26	1082586	20	1082784	12
1082146	22	1082344	26	1082587	20	1082785	12
1082147	22	1082345	26	1082589	20	1082786	12
1082148	22	1082346	26	1082593	20	1082789	12
1082149	22	1082347	26	1082594	20	1082791	12
1082151	22	1082348	26	1082596	20	1082792	12

NRF nr.	Side	NRF nr.	Side	NRF nr.	Side	NRF nr.	Side
1082793	12	1082978	16	1083156	18	1083492	288
1082794	12	1082981	16	1083159	18	1083493	288
1082796	12	1082982	16	1083163	18	1083494	288
1082797	12	1082983	16	1083206	15	1083495	289
1082798	12	1082984	16	1083209	15	1083496	280
1082799	12	1082985	16	1083213	15	1083497	280
1082801	12	1082987	16	1083216	15	1083498	281
1082803	12	1082988	16	1083219	15	1083499	281
1082804	12	1082989	16	1083233	24	1083502	283
1082805	12	1082991	16	1083236	24	1083504	309
1082806	12	1082992	16	1083239	24	1083797	21
1082807	12	1082993	16	1083243	24	1083798	21
1082808	12	1083006	16	1083246	24	1083799	21
1082809	12	1083008	291	1083249	24	1083801	21
1082856	15	1083009	16	1083253	24	1083802	21
1082859	15	1083013	16	1083254	24	1083803	22
1082863	15	1083014	292	1083255	24	1083804	25
1082866	15	1083016	16	1083321	27	1083805	25
1082869	15	1083019	16	1083323	27	1083806	25
1082873	15	1083043	17	1083349	28	1083807	25
1082876	15	1083046	17	1083353	28	1083808	25
1082879	15	1083049	17	1083356	28	1083809	25
1082882	15	1083053	17	1083373	27	1083811	25
1082883	15	1083056	17	1083376	27	1083812	25
1082884	15	1083057	17	1083379	27	1083813	17
1082894	20	1083059	17	1083386	27	1083814	17
1082895	20	1083061	17	1083393	27	1083815	17
1082896	20	1083063	17	1083419	26	1083816	17
1082897	20	1083064	17	1083421	26	1083817	17
1082909	16	1083066	17	1083422	26	1083818	17
1082913	16	1083067	17	1083423	26	1083819	17
1082916	16	1083069	17	1083424	26	1083821	17
1082919	16	1083071	17	1083425	26	1083822	17
1082923	16	1083076	17	1083426	26	1083823	17
1082926	16	1083077	17	1083427	26	1083824	18
1082929	16	1083078	17	1083428	26	1083825	18
1082933	16	1083083	23	1083429	26	1083826	18
1082936	16	1083084	23	1083431	26	1083827	11
1082939	16	1083086	23	1083452	293	1083828	11
1082943	16	1083087	23	1083453	293	1083829	11
1082946	16	1083089	23	1083454	293	1083831	20
1082949	16	1083093	23	1083455	293	1083832	20
1082951	16	1083096	23	1083456	293	1083833	21
1082952	16	1083099	23	1083457	293	1083834	21
1082953	16	1083102	23	1083458	293	1083835	20
1082956	16	1083104	23	1083472	291	1083836	20
1082959	16	1083106	23	1083473	304	1083837	20
1082961	16	1083107	23	1083474	304	1083838	20
1082962	16	1083109	23	1083475	304	1083839	20
1082963	16	1083112	23	1083476	304	1083841	20
1082966	16	1083114	23	1083477	304	1083842	20
1082969	16	1083116	23	1083478	304	1083843	27
1082973	16	1083143	18	1083487	288	1083844	27
1082975	16	1083146	18	1083488	288	1083845	27
1082976	16	1083149	18	1083489	288	1083846	27
1082977	16	1083153	18	1083491	288	1083847	27



NRF nr.	Side	NRF nr.	Side	NRF nr.	Side	NRF nr.	Side
1083848	27	1084089	316	1950129	39	1950373	50
1083849	27	1084091	317	1950133	39	1950449	41
1083851	27	1084092	292	1950136	39	1950453	41
1083852	27	1084093	280	1950139	39	1950456	41
1083853	27	1084095	281	1950153	39	1950459	41
1083854	26	1084096	290	1950156	39	1950463	41
1083855	26	1084097	291	1950159	39	1950466	41
1083856	26	1084098	290	1950161	54	1950469	41
1083857	26	1084099	290	1950162	54	1950489	39
1083858	26	1084101	282	1950163	55	1950493	39
1083859	26	1084102	282	1950164	55	1950496	39
1083861	26	1084111	281	1950165	55	1950499	39
1083862	27	1950006	57	1950166	55	1950503	39
1083863	16	1950009	57	1950167	55	1950506	39
1083864	17	1950011	70	1950168	55	1950509	39
1083865	17	1950012	70	1950169	55	1950523	39
1083866	17	1950013	70	1950171	55	1950526	39
1083867	17	1950016	57	1950172	55	1950529	39
1083868	17	1950019	57	1950173	55	1950559	40
1083869	17	1950023	57	1950174	54	1950563	40
1083871	17	1950026	57	1950175	54	1950566	40
1083872	23	1950029	57	1950176	54	1950569	40
1083873	23	1950042	45	1950177	54	1950573	40
1083874	23	1950043	45	1950178	54	1950576	40
1083875	23	1950044	45	1950179	54	1950579	40
1083876	23	1950045	45	1950181	54	1950593	40
1083877	23	1950046	45	1950182	54	1950596	40
1083878	23	1950047	45	1950191	163	1950599	40
1083879	23	1950048	45	1950192	163	1950649	37
1083881	88	1950049	45	1950193	163	1950653	37
1083882	88	1950051	45	1950194	163	1950656	37
1083883	88	1950052	45	1950195	163	1950659	37
1083884	88	1950053	163	1950196	163	1950663	37
1084003	301	1950054	163	1950197	163	1950666	37
1084004	281	1950055	163	1950249	40	1950669	37
1084005	292	1950056	163	1950252	40	1950683	37
1084046	289	1950057	163	1950253	40	1950686	37
1084057	289	1950058	163	1950256	40	1950689	37
1084061	280	1950059	163	1950259	40	1950709	37
1084063	305	1950063	57	1950263	40	1950713	37
1084064	306	1950066	57	1950266	40	1950716	37
1084068	283	1950069	57	1950283	40	1950719	37
1084069	282	1950088	54	1950286	40	1950723	37
1084071	282	1950089	54	1950289	40	1950726	37
1084074	283	1950091	54	1950309	50	1950729	37
1084075	290	1950092	54	1950313	50	1950733	37
1084076	290	1950093	164	1950316	50	1950736	37
1084077	290	1950094	164	1950319	50	1950739	37
1084081	316	1950095	164	1950323	50	1950759	47
1084082	314	1950096	164	1950326	50	1950763	47
1084083	315	1950097	164	1950329	50	1950764	47
1084084	315	1950098	164	1950359	50	1950765	47
1084085	316	1950099	164	1950363	50	1950766	47
1084086	316	1950119	39	1950364	50	1950767	47
1084087	316	1950123	39	1950366	50	1950768	47
1084088	316	1950126	39	1950369	50	1950769	47

NRF nr.	Side	NRF nr.	Side	NRF nr.	Side	NRF nr.	Side
1950772	47	1950989	42	1951169	44	1951843	41
1950773	47	1950993	42	1951173	44	1951963	48
1950774	47	1950996	42	1951176	44	1951965	48
1950776	47	1950999	42	1951179	44	1951967	48
1950778	47	1951003	42	1951183	44	1951969	48
1950779	47	1951006	42	1951186	44	1951972	48
1950783	47	1951009	42	1951189	44	1951974	48
1950786	47	1951023	42	1951193	44	1952001	29
1950809	49	1951026	42	1951196	44	1952003	29
1950811	49	1951029	42	1951209	44	1952005	29
1950812	49	1951031	45	1951223	44	1952007	29
1950813	49	1951032	45	1951225	44	1952009	29
1950814	49	1951034	45	1951226	44	1952012	29
1950815	49	1951056	43	1951228	44	1952014	29
1950816	49	1951059	43	1951229	44	1952016	29
1950817	49	1951062	43	1951235	44	1952018	29
1950818	49	1951063	43	1951259	56	1952021	29
1950819	49	1951065	43	1951263	56	1952023	29
1950822	49	1951066	43	1951266	56	1952093	55
1950823	49	1951069	43	1951289	56	1952095	55
1950826	49	1951071	43	1951309	52	1952097	55
1950829	49	1951073	43	1951311	52	1952099	55
1950832	51	1951076	43	1951313	52	1952102	55
1950834	51	1951077	43	1951314	52	1952104	55
1950836	51	1951078	43	1951315	52	1952106	55
1950838	51	1951079	43	1951316	52	1952108	55
1950841	51	1951083	43	1951317	52	1952111	56
1950843	51	1951086	43	1951319	52	1952112	56
1950845	51	1951087	43	1951323	52	1952113	56
1950856	38	1951088	43	1951326	52	1952114	56
1950859	38	1951089	43	1951329	52	1952115	56
1950863	38	1951093	43	1951359	42	1952116	56
1950864	38	1951096	43	1951363	42	1952117	56
1950865	38	1951099	43	1951366	42	1952118	56
1950866	38	1951117	43	1951369	42	1952119	56
1950867	38	1951118	43	1951722	53	1952121	56
1950868	38	1951119	43	1951724	53	1952142	29
1950869	38	1951121	43	1951726	53	1952144	29
1950872	38	1951122	43	1951728	53	1952146	29
1950873	38	1951123	43	1951731	53	1952148	29
1950874	38	1951124	43	1951733	53	1952151	29
1950875	38	1951125	43	1951735	53	1952153	29
1950876	38	1951126	43	1951737	53	1952155	29
1950877	38	1951127	43	1951739	53	1952157	29
1950878	38	1951128	43	1951742	53	1952159	29
1950879	38	1951129	43	1951756	41	1952162	29
1950881	38	1951131	43	1951758	41	1952164	29
1950882	38	1951132	43	1951761	41	1952225	30
1950883	38	1951133	43	1951763	41	1952227	30
1950884	38	1951134	43	1951796	41	1952228	30
1950893	38	1951135	43	1951798	41	1952229	30
1950894	38	1951136	43	1951801	41	1952231	30
1950896	38	1951159	44	1951803	41	1952232	30
1950897	38	1951163	44	1951836	41	1952243	30
1950898	38	1951164	44	1951838	41	1952244	30
1950899	38	1951166	44	1951841	41	1952245	30



NRF nr.	Side	NRF nr.	Side	NRF nr.	Side	NRF nr.	Side
1952246	30	1952318	40	1952381	41	1952443	52
1952247	30	1952319	40	1952382	41	1952444	52
1952248	30	1952321	40	1952383	41	1952445	52
1952249	30	1952322	54	1952384	41	1952446	52
1952261	50	1952323	54	1952385	41	1952447	52
1952262	39	1952324	54	1952386	41	1952448	52
1952263	39	1952325	54	1952387	41	1952449	52
1952264	39	1952326	42	1952388	41	1952451	52
1952265	39	1952327	42	1952389	41	1952452	52
1952266	39	1952328	47	1952391	41	1952453	52
1952267	39	1952329	47	1952392	41	1952454	53
1952268	39	1952331	47	1952393	41	1952455	53
1952269	39	1952332	49	1952394	41	1952456	53
1952271	39	1952333	49	1952395	41	1952457	53
1952272	40	1952334	49	1952396	55	1952458	53
1952273	40	1952335	49	1952397	55	1952459	53
1952274	40	1952336	48	1952398	55	1952461	53
1952275	40	1952337	49	1952399	55	1952462	51
1952276	40	1952338	49	1952401	55	1952463	51
1952277	40	1952339	49	1952402	55	1952464	51
1952278	40	1952341	49	1952403	55	1952465	51
1952279	40	1952342	49	1952404	55	1952466	51
1952281	40	1952343	49	1952405	55	1952467	51
1952282	39	1952344	49	1952406	55	1952468	51
1952283	39	1952345	49	1952407	43	1952469	52
1952284	39	1952346	51	1952408	43	1952471	52
1952285	39	1952347	51	1952409	43	1952472	52
1952286	39	1952348	51	1952411	43	1952473	52
1952287	39	1952349	51	1952412	43	1952474	52
1952288	39	1952351	51	1952413	43	1952475	52
1952289	39	1952352	51	1952414	43	1952476	52
1952291	39	1952353	51	1952415	43	1952477	48
1952292	40	1952354	51	1952416	44	1952478	48
1952293	40	1952355	51	1952417	44	1952479	48
1952294	40	1952356	51	1952418	44	1952481	48
1952295	40	1952357	51	1952419	44	1952482	48
1952296	40	1952358	51	1952421	44	1952483	48
1952297	40	1952359	49	1952422	44	1952484	48
1952298	40	1952361	49	1952423	53	1952485	70
1952299	40	1952362	49	1952424	53	1952486	70
1952301	40	1952363	49	1952425	53	1952487	70
1952302	39	1952364	49	1952426	53	1952488	70
1952303	39	1952365	41	1952427	53	1952489	70
1952304	39	1952366	41	1952428	53	1952491	70
1952305	39	1952367	41	1952429	53	1952492	70
1952306	39	1952368	41	1952431	53	2272255	246
1952307	39	1952369	41	1952432	53	2272259	246
1952308	39	1952371	41	1952433	53	2272269	246
1952309	39	1952372	41	1952434	50	2272274	246
1952311	39	1952373	41	1952435	50	2272279	246
1952312	40	1952374	41	1952436	50	2272284	246
1952313	40	1952375	41	1952437	50	2272289	246
1952314	40	1952376	41	1952438	50	2272294	246
1952315	40	1952377	41	1952439	50	2290004	222
1952316	40	1952378	41	1952441	50	2290005	243
1952317	40	1952379	41	1952442	52	2290006	242

NRF nr.	Side	NRF nr.	Side	NRF nr.	Side	NRF nr.	Side
2290007	248	2290132	247	2290194	239	2290256	228
2290008	248	2290133	246	2290195	239	2290257	228
2290009	222	2290134	247	2290196	239	2290258	244
2290011	234	2290135	246	2290197	239	2290259	251
2290012	234	2290136	247	2290198	239	2290261	236
2290013	234	2290137	246	2290199	239	2290262	236
2290014	234	2290138	247	2290201	239	2290263	236
2290015	234	2290139	246	2290202	239	2290264	236
2290016	234	2290141	247	2290203	239	2290265	237
2290017	234	2290142	247	2290204	225	2290266	252
2290018	234	2290143	254	2290205	225	2290267	252
2290019	234	2290144	224	2290206	225	2290268	252
2290021	222	2290145	223	2290207	225	2290269	252
2290026	222	2290146	223	2290208	225	2290271	252
2290032	222	2290147	223	2290209	225	2290272	252
2290043	222	2290148	223	2290211	225	2290273	252
2290048	222	2290149	223	2290212	226	2290274	252
2290053	222	2290151	223	2290213	226	2290275	235
2290065	222	2290152	224	2290214	226	2290276	235
2290071	222	2290153	224	2290215	226	2290277	235
2290076	222	2290154	224	2290216	226	2290278	245
2290082	222	2290155	224	2290217	226	2290279	245
2290087	222	2290156	226	2290218	226	2290281	245
2290088	28	2290157	251	2290219	226	2290282	236
2290089	250	2290158	251	2290221	226	2290283	236
2290091	250	2290159	224	2290222	226	2290284	236
2290092	249	2290161	227	2290223	226	2290285	238
2290093	249	2290162	229	2290224	226	2290286	238
2290094	249	2290163	229	2290225	227	2290287	238
2290095	246	2290164	229	2290226	227	2290288	238
2290096	246	2290165	229	2290227	254	2290289	238
2290098	246	2290166	229	2290228	254	2290291	238
2290101	246	2290167	229	2290229	254	2290292	238
2290103	246	2290168	229	2290231	254	2290293	238
2290105	246	2290169	229	2290232	254	2290294	238
2290107	246	2290171	229	2290233	228	2290295	238
2290109	255	2290172	247	2290234	228	2290296	238
2290111	255	2290173	247	2290235	227	2290297	236
2290112	248	2290174	247	2290236	227	2290298	236
2290113	248	2290175	244	2290237	228	2290299	236
2290114	248	2290176	244	2290238	227	2290301	236
2290115	248	2290177	243	2290239	228	2290302	236
2290116	248	2290178	229	2290241	228	2290303	236
2290117	248	2290179	229	2290242	228	2290304	236
2290118	248	2290181	230	2290243	228	2290305	235
2290119	248	2290182	230	2290244	228	2290306	235
2290121	248	2290183	230	2290245	227	2290307	235
2290122	247	2290184	229	2290246	227	2290308	235
2290123	246	2290185	230	2290247	227	2290309	252
2290124	247	2290186	233	2290248	227	2290311	252
2290125	246	2290187	233	2290249	227	2290312	252
2290126	247	2290188	233	2290251	227	2290313	252
2290127	246	2290189	233	2290252	227	2290314	252
2290128	246	2290191	233	2290253	227	2290315	252
2290129	247	2290192	233	2290254	228	2290316	252
2290131	246	2290193	239	2290255	228	2290317	252



NRF nr.	Side	NRF nr.	Side	NRF nr.	Side	NRF nr.	Side
2290318	252	2290506	223	2291255	225	2291408	226
2290319	253	2290508	223	2291257	225	2291413	226
2290321	252	2290511	223	2291259	225	2291415	226
2290325	223	2290513	223	2291262	225	2291417	226
2290326	223	2290515	223	2291264	225	2291419	226
2290327	223	2290517	223	2291266	225	2291422	226
2290328	223	2290519	223	2291268	225	2291424	226
2290329	223	2290522	223	2291271	225	2291428	226
2290331	223	2290524	223	2291273	225	2291433	226
2290332	230	2290526	223	2291275	225	2291435	226
2290333	240	2290528	223	2291277	225	2291442	226
2290334	240	2290531	223	2291279	225	2291444	227
2290335	240	2290558	222	2291282	225	2291453	227
2290336	240	2290561	222	2291284	225	2291455	227
2290337	240	2290563	222	2291286	225	2291457	227
2290338	251	2290565	222	2291288	225	2291459	227
2290339	251	2290567	222	2291291	225	2291602	228
2290341	232	2290569	222	2291295	225	2291652	227
2290342	245	2290572	222	2291297	225	2291697	227
2290343	245	2290574	222	2291299	225	2291711	227
2290344	235	2290604	222	2291302	225	2291742	228
2290345	235	2290608	222	2291304	225	2291781	228
2290346	235	2290611	222	2291306	225	2291822	228
2290347	235	2290613	222	2291308	225	2291884	231
2290348	235	2290615	222	2291311	225	2291886	231
2290349	235	2290617	222	2291315	225	2291888	231
2290351	235	2290619	222	2291317	225	2291891	231
2290352	235	2290622	222	2291319	225	2291893	231
2290353	235	2290624	222	2291322	225	2291895	231
2290354	240	2290626	222	2291326	225	2291974	231
2290355	242	2290628	223	2291328	225	2291976	231
2290356	242	2290632	223	2291331	225	2291978	231
2290357	241	2290996	242	2291333	225	2291981	231
2290358	242	2290998	243	2291354	227	2291983	231
2290359	237	2291036	244	2291356	226	2291985	231
2290361	237	2291073	244	2291358	226	2292006	230
2290362	237	2291112	203	2291361	226	2292008	230
2290363	237	2291113	203	2291363	226	2292011	230
2290364	237	2291114	203	2291365	226	2292013	230
2290365	237	2291115	203	2291367	226	2292015	230
2290366	237	2291116	203	2291372	226	2292017	230
2290367	245	2291122	203	2291374	226	2292019	230
2290368	245	2291224	225	2291376	226	2292022	230
2290369	248	2291226	225	2291378	226	2292024	230
2290371	248	2291228	225	2291381	226	2292026	230
2290372	217	2291231	225	2291383	226	2292028	230
2290373	28	2291233	225	2291385	226	2292031	230
2290374	29	2291235	225	2291387	226	2292033	230
2290375	249	2291237	225	2291389	226	2292035	230
2290376	249	2291239	225	2291392	226	2292037	230
2290377	242	2291242	225	2291394	226	2292039	230
2290378	247	2291244	225	2291396	226	2292042	230
2290379	247	2291246	225	2291398	226	2292044	230
2290381	247	2291248	225	2291402	226	2292046	230
2290382	247	2291251	225	2291404	226	2292048	230
2290504	223	2291253	225	2291406	226	2292051	230

NRF nr.	Side	NRF nr.	Side	NRF nr.	Side	NRF nr.	Side
2292053	230	2292466	232	2293161	240	2293723	176
2292055	230	2292468	232	2293165	240	2293724	176
2292064	230	2292471	213	2293167	240	2293725	176
2292068	230	2292473	213	2293169	240	2293726	176
2292071	230	2292475	213	2293172	240	2293727	176
2292111	229	2292477	213	2293174	240	2293728	176
2292113	229	2292479	213	2293176	240	2293729	176
2292115	229	2292482	232	2293178	240	2293731	176
2292117	229	2292483	213	2293181	240	2293732	176
2292119	229	2292484	213	2293208	253	2293733	176
2292122	229	2292514	232	2293211	253	2293734	176
2292124	229	2292516	232	2293215	253	2293735	176
2292126	229	2292518	232	2293217	253	2293736	176
2292128	229	2292534	241	2293219	253	2293737	176
2292131	229	2292536	241	2293222	253	2293738	176
2292135	229	2292538	241	2293224	253	2293739	176
2292137	229	2292541	241	2293258	239	2293741	176
2292139	229	2292543	241	2293261	239	2293742	176
2292146	229	2292545	241	2293265	239	2293743	176
2292148	229	2292547	241	2293267	239	2293744	176
2292151	229	2292549	241	2293271	239	2293745	176
2292153	229	2292604	237	2293273	239	2293746	176
2292155	229	2292606	237	2293275	239	2293747	177
2292157	229	2292608	237	2293277	239	2293748	177
2292159	229	2292611	237	2293279	239	2293749	177
2292162	229	2292613	237	2293604	251	2293751	177
2292164	229	2292615	237	2293612	251	2293752	177
2292166	229	2292617	237	2293643	251	2293753	177
2292168	229	2292619	237	2293645	251	2293754	177
2292171	229	2292634	237	2293647	251	2293755	177
2292173	229	2292636	237	2293649	251	2293756	177
2292225	230	2292638	237	2293652	251	2293757	177
2292227	230	2292641	237	2293654	251	2293758	177
2292229	230	2292643	237	2293656	251	2293759	177
2292232	230	2292645	237	2293658	251	2293761	177
2292236	230	2292647	237	2293661	251	2293762	177
2292258	236	2292649	237	2293701	176	2293763	177
2292263	236	2292861	238	2293702	176	2293764	177
2292274	236	2292863	238	2293703	176	2293765	177
2292298	236	2292865	238	2293704	176	2293766	177
2292303	236	2292872	238	2293705	176	2293767	177
2292334	233	2292876	238	2293706	176	2293768	177
2292336	233	2292878	238	2293707	176	2293769	177
2292338	233	2292915	238	2293708	176	2293771	177
2292341	233	2292917	238	2293709	176	2293772	177
2292343	233	2293108	240	2293711	176	2293773	177
2292345	233	2293111	240	2293712	176	2293774	177
2292347	233	2293113	240	2293713	176	2293775	177
2292349	233	2293115	240	2293714	176	2293776	177
2292352	233	2293117	240	2293715	176	2293777	177
2292354	233	2293119	240	2293716	176	2293778	178
2292356	233	2293122	240	2293717	176	2293779	178
2292358	233	2293124	240	2293718	176	2293781	178
2292361	233	2293126	240	2293719	176	2293782	178
2292435	252	2293128	240	2293721	176	2293783	178
2292439	252	2293158	240	2293722	176	2293784	178



NRF nr.	Side	NRF nr.	Side	NRF nr.	Side	NRF nr.	Side
2293785	178	2293847	181	2293909	185	2294046	208
2293786	178	2293848	181	2293911	184	2294049	208
2293787	178	2293849	181	2293912	184	2294053	208
2293788	178	2293851	181	2293913	184	2294056	208
2293789	178	2293852	181	2293914	185	2294058	208
2293791	178	2293853	181	2293915	185	2294076	208
2293792	178	2293854	181	2293916	185	2294079	208
2293793	178	2293855	181	2293917	274	2294083	208
2293794	178	2293856	181	2293918	187	2294086	208
2293795	178	2293857	181	2293919	215	2294096	208
2293796	178	2293858	182	2293921	234	2294099	208
2293797	178	2293859	182	2293922	215	2294103	208
2293798	178	2293861	182	2293923	215	2294106	208
2293799	178	2293862	182	2293924	215	2294108	208
2293801	178	2293863	182	2293925	215	2294126	208
2293802	178	2293864	182	2293926	215	2294129	208
2293803	178	2293865	182	2293927	215	2294133	208
2293804	178	2293866	182	2293928	234	2294136	208
2293805	178	2293867	182	2293929	215	2294137	183
2293806	178	2293868	184	2293931	185	2294138	183
2293807	178	2293869	184	2293932	185	2294139	183
2293808	178	2293871	184	2293933	185	2294141	183
2293809	178	2293872	184	2293934	215	2294142	183
2293811	178	2293873	184	2293935	215	2294143	183
2293812	179	2293874	184	2293936	215	2294144	183
2293813	179	2293875	184	2293937	234	2294145	183
2293814	179	2293876	184	2293938	234	2294146	183
2293815	178	2293877	184	2293939	215	2294147	183
2293816	179	2293878	184	2293941	234	2294148	183
2293817	179	2293879	184	2293942	215	2294149	183
2293818	179	2293881	184	2293943	215	2294151	182
2293819	179	2293882	184	2293944	234	2294152	182
2293821	180	2293883	184	2294006	208	2294153	183
2293822	180	2293884	184	2294009	208	2294154	183
2293823	180	2293885	184	2294013	208	2294156	209
2293824	180	2293886	186	2294016	208	2294159	209
2293825	180	2293887	185	2294018	208	2294163	209
2293826	180	2293888	185	2294019	214	2294166	209
2293827	180	2293889	185	2294021	214	2294168	209
2293828	180	2293891	185	2294022	214	2294186	216
2293829	180	2293892	186	2294023	214	2294189	216
2293831	180	2293893	186	2294024	214	2294206	210
2293832	180	2293894	186	2294025	216	2294209	210
2293833	180	2293895	270	2294026	209	2294213	210
2293834	180	2293896	270	2294027	209	2294216	210
2293835	179	2293897	270	2294028	209	2294219	210
2293836	179	2293898	270	2294029	270	2294223	210
2293837	179	2293899	270	2294031	270	2294226	210
2293838	181	2293901	270	2294032	270	2294229	210
2293839	181	2293902	270	2294033	271	2294233	210
2293841	181	2293903	215	2294034	271	2294236	210
2293842	181	2293904	215	2294035	271	2294238	210
2293843	181	2293905	215	2294036	271	2294241	210
2293844	181	2293906	185	2294037	271	2294256	211
2293845	181	2293907	185	2294038	271	2294259	211
2293846	181	2293908	185	2294039	271	2294263	211

NRF nr.	Side	NRF nr.	Side	NRF nr.	Side	NRF nr.	Side
2294266	211	2294612	191	2294678	190	2294747	197
2294269	211	2294613	192	2294682	198	2294748	191
2294273	211	2294614	193	2294683	198	2294749	191
2294276	211	2294615	201	2294684	197	2294751	191
2294279	211	2294616	200	2294685	191	2294752	191
2294283	211	2294617	202	2294686	191	2294753	191
2294286	211	2294618	190	2294687	191	2294754	197
2294287	211	2294619	190	2294688	191	2294755	186
2294288	211	2294623	198	2294689	191	2294756	192
2294306	211	2294624	198	2294691	197	2294757	192
2294316	212	2294625	197	2294692	186	2294758	192
2294319	212	2294626	191	2294693	192	2294759	192
2294323	212	2294627	191	2294694	192	2294761	192
2294336	213	2294628	191	2294695	192	2294762	193
2294339	213	2294629	191	2294696	193	2294763	193
2294342	213	2294631	191	2294697	193	2294764	193
2294356	214	2294632	202	2294698	193	2294765	192
2294359	214	2294633	192	2294699	196	2294766	192
2294363	214	2294634	192	2294701	199	2294767	195
2294366	214	2294635	193	2294702	185	2294768	194
2294368	214	2294636	196	2294703	202	2294769	195
2294371	214	2294637	201	2294704	190	2294771	194
2294373	214	2294638	200	2294705	191	2294772	193
2294375	214	2294639	200	2294708	198	2294773	193
2294386	212	2294641	202	2294709	198	2294774	192
2294389	212	2294642	190	2294711	197	2294775	196
2294393	212	2294643	190	2294712	191	2294776	196
2294396	213	2294646	198	2294713	191	2294777	196
2294399	213	2294647	198	2294714	191	2294778	196
2294403	213	2294648	197	2294715	191	2294779	201
2294405	213	2294649	191	2294716	191	2294781	201
2294466	203	2294651	191	2294717	197	2294782	199
2294469	203	2294652	191	2294718	186	2294783	185
2294473	203	2294653	191	2294719	192	2294784	202
2294476	203	2294654	191	2294721	192	2294785	190
2294479	203	2294655	196	2294722	192	2294786	191
2294506	214	2294656	197	2294723	193	2294789	198
2294526	217	2294657	186	2294724	193	2294791	198
2294529	217	2294658	192	2294725	192	2294792	197
2294533	217	2294659	192	2294726	195	2294793	191
2294536	217	2294661	192	2294727	194	2294794	191
2294539	217	2294662	193	2294728	195	2294795	191
2294551	250	2294663	193	2294729	194	2294796	191
2294555	217	2294664	196	2294731	193	2294797	191
2294566	270	2294665	196	2294732	192	2294798	197
2294569	270	2294666	196	2294733	196	2294799	186
2294573	270	2294667	201	2294734	196	2294801	192
2294581	270	2294668	200	2294735	196	2294802	192
2294601	190	2294669	200	2294736	201	2294803	192
2294602	190	2294671	200	2294737	199	2294804	193
2294605	198	2294672	200	2294738	185	2294805	193
2294606	198	2294673	201	2294739	202	2294806	193
2294607	191	2294674	199	2294741	190	2294807	194
2294608	191	2294675	185	2294742	191	2294808	193
2294609	191	2294676	202	2294745	198	2294809	196
2294611	191	2294677	190	2294746	198	2294811	199



NRF nr.	Side	NRF nr.	Side	NRF nr.	Side	NRF nr.	Side
2294812	185	2472033	162	2472225	131	2472354	128
2294813	202	2472034	163	2472227	131	2472356	128
2294814	190	2472035	163	2472229	131	2472357	128
2294815	191	2472036	162	2472232	131	2472358	128
2294816	198	2472037	162	2472234	131	2472359	128
2294817	198	2472038	162	2472236	131	2472361	128
2294818	197	2472039	162	2472238	131	2472363	125
2294819	191	2472041	162	2472241	19	2472365	125
2294821	191	2472042	162	2472242	19	2472367	125
2294822	191	2472043	124	2472243	19	2472369	125
2294823	191	2472044	151	2472244	19	2472383	127
2294824	191	2472045	124	2472245	19	2472385	127
2294825	197	2472046	46	2472246	19	2472387	127
2294826	186	2472047	46	2472247	19	2472389	127
2294827	192	2472048	46	2472248	19	2472392	127
2294828	192	2472049	46	2472253	132	2472394	127
2294829	192	2472051	46	2472255	132	2472396	127
2294831	193	2472052	46	2472257	132	2472398	127
2294832	193	2472053	46	2472259	132	2472401	127
2294833	193	2472054	46	2472262	132	2472405	127
2294834	196	2472055	46	2472263	132	2472407	127
2294835	196	2472056	298	2472264	132	2472409	127
2294836	185	2472057	297	2472266	132	2472414	127
2294837	202	2472058	46	2472269	132	2472416	127
2294838	202	2472059	153	2472272	126	2472421	127
2294888	208	2472061	153	2472273	126	2472423	127
2296151	309	2472062	153	2472275	126	2472425	127
2472001	124	2472064	153	2472277	126	2472426	127
2472002	124	2472066	154	2472279	126	2472427	127
2472003	124	2472067	154	2472282	126	2472429	127
2472004	151	2472068	154	2472284	126	2472432	127
2472005	124	2472069	149	2472286	126	2472434	127
2472006	151	2472071	149	2472293	126	2472436	127
2472007	124	2472072	153	2472295	126	2472438	127
2472008	151	2472073	153	2472297	126	2472441	127
2472009	124	2472074	146	2472299	126	2472443	127
2472011	151	2472088	149	2472302	126	2472445	127
2472012	124	2472089	150	2472304	126	2472447	127
2472013	151	2472091	154	2472312	127	2472449	127
2472014	124	2472092	154	2472313	127	2472451	127
2472015	151	2472093	154	2472315	127	2472452	125
2472016	124	2472094	154	2472317	127	2472453	125
2472017	124	2472095	154	2472319	127	2472455	125
2472018	124	2472096	154	2472322	127	2472457	125
2472019	124	2472097	154	2472324	127	2472459	125
2472021	124	2472098	153	2472326	127	2472462	125
2472022	128	2472099	153	2472333	128	2472464	125
2472023	128	2472106	147	2472335	128	2472466	125
2472024	157	2472108	147	2472339	128	2472473	126
2472025	157	2472111	153	2472342	128	2472475	126
2472026	124	2472119	147	2472344	128	2472477	126
2472027	162	2472121	145	2472346	128	2472482	126
2472028	162	2472122	146	2472348	128	2472484	126
2472029	162	2472123	135	2472351	128	2472486	126
2472031	162	2472125	135	2472352	128	2472488	126
2472032	162	2472223	131	2472353	128	2472491	126

NRF nr.	Side	NRF nr.	Side	NRF nr.	Side	NRF nr.	Side
2472493	126	2472619	132	2472847	306	2473422	134
2472495	126	2472621	132	2472853	299	2473423	134
2472497	126	2472622	132	2472901	28	2473424	145
2472499	126	2472623	132	2472902	28	2473425	145
2472501	126	2472624	132	2472903	135	2473426	145
2472502	126	2472625	132	2472904	135	2473427	145
2472503	126	2472626	132	2472905	134	2473428	145
2472523	130	2472633	133	2472906	128	2473429	145
2472525	130	2472635	133	2472907	135	2473431	145
2472527	130	2472637	133	2472908	135	2473432	145
2472529	130	2472639	133	2472909	135	2473433	145
2472532	130	2472641	133	2472911	135	2473434	145
2472534	130	2472642	133	2472912	135	2473435	145
2472536	130	2472643	133	2472913	124	2473436	145
2472537	130	2472644	133	2472914	124	2473437	145
2472538	130	2472646	133	2472915	124	2473438	145
2472541	130	2472653	133	2472916	125	2473439	151
2472542	130	2472655	133	2472917	124	2473441	151
2472543	130	2472657	133	2472918	125	2473442	151
2472544	130	2472659	133	2472919	125	2473443	151
2472545	130	2472662	133	2472922	19	2473444	151
2472546	130	2472664	133	2472923	19	2473445	151
2472547	130	2472666	133	2472924	130	2473446	151
2472563	131	2472668	133	2472925	130	2473447	151
2472565	131	2472671	133	2472926	130	2473448	151
2472567	131	2472673	133	2472927	130	2473449	151
2472569	131	2472675	133	2472928	130	2473451	151
2472572	131	2472677	133	2472929	130	2473452	151
2472574	131	2472679	133	2472931	130	2473453	151
2472575	131	2472682	133	2472932	130	2473454	151
2472576	131	2472684	133	2472933	131	2473455	151
2472577	131	2472685	133	2472934	133	2473456	151
2472578	131	2472686	133	2472935	133	2473457	151
2472579	131	2472687	133	2472936	133	2473458	151
2472581	131	2472688	133	2472937	133	2473459	151
2472582	131	2472689	133	2472938	130	2473461	151
2472583	131	2472691	133	2472939	130	2473462	156
2472585	131	2472693	133	2472941	130	2473463	156
2472593	132	2472694	133	2472942	130	2473464	156
2472595	132	2472695	133	2472943	130	2473465	156
2472597	132	2472711	162	2472944	130	2473466	156
2472599	132	2472712	162	2472945	130	2473467	156
2472602	132	2472713	162	2472946	134	2473468	156
2472603	132	2472714	162	2472947	134	2473469	156
2472604	132	2472753	137	2472948	125	2473471	156
2472605	305	2472755	137	2472949	125	2473472	142
2472606	305	2472757	137	2472951	136	2473473	142
2472607	305	2472759	137	2472952	136	2473474	142
2472608	305	2472761	137	2472953	135	2473475	142
2472609	305	2472762	137	2472954	135	2473476	142
2472611	305	2472782	298	2472955	135	2473477	142
2472612	304	2472783	298	2472956	135	2473478	142
2472613	132	2472786	299	2472957	131	2473479	142
2472615	132	2472788	307	2472958	132	2473481	142
2472616	132	2472791	307	2472959	131	2473482	142
2472617	132	2472845	303	2473421	134	2473483	142



NRF nr.	Side	NRF nr.	Side	NRF nr.	Side	NRF nr.	Side
2473484	142	2473546	146	2473608	18	2473672	152
2473485	142	2473547	146	2473609	18	2473673	152
2473486	142	2473548	146	2473611	18	2473674	152
2473487	142	2473549	146	2473612	18	2473675	152
2473488	142	2473551	146	2473613	18	2473676	152
2473489	142	2473552	146	2473614	18	2473677	152
2473491	142	2473553	146	2473615	18	2473678	152
2473492	142	2473554	146	2473616	46	2473679	152
2473493	142	2473555	146	2473618	46	2473681	152
2473494	143	2473556	146	2473619	46	2473682	152
2473495	143	2473557	146	2473621	46	2473683	152
2473496	143	2473558	146	2473622	46	2473684	152
2473497	143	2473559	146	2473623	46	2473685	152
2473498	143	2473561	146	2473624	46	2473686	152
2473499	143	2473562	146	2473625	149	2473687	152
2473501	143	2473563	146	2473626	149	2473688	152
2473502	143	2473564	146	2473627	149	2473689	152
2473503	143	2473565	146	2473628	149	2473691	152
2473504	143	2473566	146	2473629	149	2473692	152
2473505	143	2473567	146	2473631	149	2473693	152
2473506	143	2473568	146	2473632	149	2473694	152
2473507	143	2473569	146	2473633	149	2473695	152
2473508	144	2473571	146	2473634	149	2473696	152
2473509	144	2473572	146	2473635	149	2473697	152
2473511	144	2473573	146	2473636	149	2473698	152
2473512	144	2473574	146	2473637	149	2473699	152
2473513	144	2473575	146	2473638	149	2473701	152
2473514	144	2473576	146	2473639	149	2473702	152
2473515	144	2473577	146	2473641	149	2473703	152
2473516	144	2473578	146	2473642	149	2473704	153
2473517	144	2473579	146	2473643	149	2473705	153
2473518	144	2473581	147	2473644	149	2473706	153
2473519	144	2473582	146	2473645	150	2473707	153
2473521	144	2473583	146	2473646	150	2473708	153
2473522	144	2473584	146	2473647	150	2473709	153
2473523	144	2473585	146	2473648	150	2473711	153
2473524	144	2473586	147	2473649	150	2473712	153
2473525	144	2473587	147	2473651	150	2473713	153
2473526	144	2473588	146	2473652	150	2473714	153
2473527	144	2473589	146	2473653	150	2473715	153
2473528	144	2473591	147	2473654	150	2473716	153
2473529	144	2473592	147	2473655	150	2473717	153
2473531	144	2473593	147	2473656	150	2473718	153
2473532	145	2473594	146	2473657	150	2473719	153
2473533	145	2473595	147	2473658	150	2473721	153
2473534	145	2473596	129	2473659	150	2473722	153
2473535	145	2473597	129	2473661	150	2473723	153
2473536	145	2473598	129	2473662	150	2473724	153
2473537	145	2473599	129	2473663	150	2473725	153
2473538	145	2473601	129	2473664	150	2473726	153
2473539	145	2473602	129	2473665	150	2473727	153
2473541	146	2473603	129	2473666	150	2473728	153
2473542	146	2473604	129	2473667	150	2473729	153
2473543	146	2473605	18	2473668	150	2473731	153
2473544	146	2473606	18	2473669	150	2473732	153
2473545	146	2473607	18	2473671	150	2473733	153

NRF nr.	Side	NRF nr.	Side	NRF nr.	Side	NRF nr.	Side
2473734	153	3406801	259	5017872	111	5017934	116
2473735	153	3406802	265	5017873	111	5052114	89
2473736	153	3406803	265	5017874	111	5052116	78
2473737	153	3406804	263	5017875	111	5052119	78
2473738	153	3406805	263	5017876	111	5052123	78
2473739	153	3406806	263	5017877	111	5052126	78
2473741	153	3406807	262	5017878	111	5052129	78
2473742	153	3406808	262	5017879	110	5052133	78
2473743	153	3406809	263	5017881	110	5052136	78
2473744	154	3406811	263	5017882	110	5052139	78
2473745	154	3406812	263	5017883	110	5052141	78
2473746	154	3406813	263	5017884	110	5052142	78
2473747	154	3406814	263	5017885	110	5052143	78
2473748	154	3406815	263	5017886	110	5052144	84
2473749	155	3406816	263	5017887	110	5052145	84
2473751	155	3406817	263	5017888	110	5052146	84
2473752	155	3406818	263	5017889	111	5052147	84
2473753	155	3407955	264	5017891	111	5052148	85
2473754	155	4520755	245	5017892	111	5052149	79
2473755	157	5017831	116	5017893	111	5052151	79
2473756	157	5017832	116	5017894	111	5052153	79
2473757	157	5017833	116	5017895	111	5052186	78
2473758	157	5017834	116	5017896	111	5052189	78
2473759	157	5017835	116	5017897	111	5052193	78
2473761	157	5017836	116	5017898	111	5052196	78
2473762	296	5017837	116	5017899	115	5052199	78
2473763	296	5017838	116	5017901	115	5052203	78
2473764	296	5017839	110	5017902	115	5052206	79
2473765	297	5017841	110	5017903	115	5052209	79
2473766	297	5017842	110	5017904	116	5052211	79
2473767	297	5017843	110	5017905	48	5052212	79
2473768	298	5017844	110	5017906	48	5052213	79
2473769	298	5017845	110	5017907	48	5052226	85
2473771	299	5017846	110	5017908	48	5052227	85
2473772	299	5017847	110	5017909	48	5052229	85
2473773	300	5017848	110	5017911	48	5052233	85
2473774	300	5017849	111	5017912	114	5052236	85
2473775	300	5017851	111	5017913	114	5052237	85
2473776	300	5017852	111	5017914	114	5052239	85
2473777	300	5017853	111	5017915	114	5052243	85
2473778	300	5017854	111	5017916	114	5052246	85
2473779	300	5017855	111	5017917	114	5052249	85
2473781	300	5017856	111	5017918	114	5052253	85
2473782	300	5017857	111	5017919	112	5052309	79
2473783	300	5017858	111	5017921	112	5052313	79
2473784	300	5017859	110	5017922	112	5052316	79
2473785	301	5017861	110	5017923	112	5052319	79
2473789	301	5017862	110	5017924	112	5052323	79
2473791	301	5017863	110	5017925	112	5052326	79
2473792	301	5017864	110	5017926	116	5052329	79
2473793	297	5017865	110	5017927	116	5052337	79
2473794	296	5017866	110	5017928	116	5052338	79
3406403	260	5017867	110	5017929	116	5052339	79
3406404	259	5017868	110	5017931	116	5052342	79
3406424	267	5017869	111	5017932	116	5052343	79
3406425	267	5017871	111	5017933	116	5052344	79



NRF nr.	Side	NRF nr.	Side	NRF nr.	Side	NRF nr.	Side
5052345	79	5052603	84	5052715	90	5052916	80
5052346	79	5052604	84	5052716	90	5052921	80
5052347	79	5052605	84	5052717	90	5052923	80
5052348	79	5052606	84	5052718	90	5052924	80
5052349	79	5052607	84	5052719	90	5052926	80
5052356	78	5052608	84	5052721	91	5052929	80
5052359	78	5052609	84	5052722	91	5052933	80
5052363	78	5052611	84	5052723	92	5052936	80
5052366	78	5052613	84	5052724	92	5052939	80
5052369	78	5052616	84	5052725	90	5052944	80
5052373	78	5052617	84	5052726	91	5052946	80
5052376	78	5052618	84	5052727	91	5052949	80
5052379	78	5052619	84	5052728	91	5052953	80
5052381	78	5052621	88	5052729	92	5052956	80
5052382	78	5052622	88	5052731	92	5052959	80
5052383	78	5052623	88	5052732	92	5052963	80
5052406	78	5052636	85	5052756	77	5052966	80
5052409	78	5052637	85	5052759	77	5052969	80
5052413	78	5052638	85	5052766	77	5052973	80
5052416	78	5052639	85	5052769	77	5052975	80
5052419	78	5052641	85	5052773	77	5052976	80
5052423	78	5052643	85	5052776	77	5052977	80
5052426	78	5052646	85	5052779	77	5052978	80
5052429	78	5052647	85	5052783	77	5052981	80
5052431	78	5052649	85	5052786	77	5052982	80
5052432	78	5052651	85	5052789	77	5052983	80
5052433	78	5052654	85	5052791	77	5052984	80
5052506	76	5052656	85	5052793	77	5052985	81
5052509	76	5052657	85	5052794	77	5052986	81
5052513	76	5052658	85	5052796	77	5052987	81
5052516	76	5052659	85	5052798	77	5052988	81
5052519	76	5052661	85	5052801	77	5053046	81
5052523	76	5052662	85	5052802	77	5053049	81
5052526	76	5052663	85	5052803	77	5053053	81
5052529	76	5052664	87	5052804	77	5053056	81
5052531	76	5052665	87	5052806	77	5053057	81
5052532	76	5052688	85	5052807	77	5053059	81
5052533	76	5052694	85	5052808	77	5053061	81
5052549	76	5052695	91	5052811	77	5053063	81
5052553	76	5052696	91	5052812	77	5053066	81
5052556	76	5052697	91	5052813	77	5053069	81
5052559	76	5052698	91	5052814	77	5053081	86
5052563	76	5052699	91	5052856	80	5053082	86
5052566	76	5052701	91	5052859	80	5053083	86
5052569	76	5052702	91	5052863	80	5053084	86
5052571	76	5052703	91	5052866	80	5053085	86
5052572	76	5052704	91	5052869	80	5053086	86
5052573	76	5052705	92	5052873	80	5053087	86
5052586	84	5052706	92	5052876	80	5053088	86
5052587	84	5052707	92	5052879	80	5053089	86
5052589	84	5052708	92	5052881	80	5053091	86
5052593	84	5052709	92	5052882	80	5053093	86
5052594	84	5052711	92	5052883	80	5053096	86
5052596	84	5052712	92	5052909	80	5053099	86
5052599	84	5052713	92	5052913	80	5053143	82
5052601	84	5052714	90	5052914	80	5053146	82

NRF nr.	Side	NRF nr.	Side	NRF nr.	Side	NRF nr.	Side
5053149	82	5053706	108	5054055	113	5054304	109
5053156	82	5053711	108	5054057	113	5054306	109
5053209	79	5053713	108	5054059	113	5054329	114
5053213	79	5053715	108	5054062	113	5054339	114
5053216	79	5053717	108	5054064	113	5054344	114
5053229	89	5053719	108	5054066	113	5054351	114
5053231	89	5053722	108	5054068	113	5054355	114
5053232	89	5053724	108	5054071	113	5054357	114
5053233	89	5053726	108	5054073	113	5054383	114
5053234	89	5053806	110	5054075	113	5054389	114
5053235	89	5053811	110	5054077	113	5054392	114
5053236	89	5053813	110	5054106	113	5054398	114
5053237	89	5053815	110	5054113	113	5054406	114
5053238	89	5053817	110	5054115	113	5054409	114
5053239	89	5053819	110	5054117	113	5054412	114
5053253	86	5053822	110	5054119	113	5054439	115
5053256	86	5053824	110	5054122	113	5054444	115
5053259	86	5053826	110	5054124	113	5054446	115
5053263	86	5053846	111	5054126	113	5054448	115
5053266	86	5053851	111	5054128	113	5054451	115
5053269	86	5053853	111	5054131	113	5054453	115
5053271	86	5053855	111	5054133	113	5054462	110
5053273	86	5053857	111	5054137	113	5054466	110
5053279	86	5053859	111	5054139	113	5054468	110
5053283	86	5053862	111	5054142	113	5054471	110
5053286	86	5053864	111	5054182	109	5054473	110
5053289	86	5053866	111	5054186	109	5054475	110
5053303	89	5053956	112	5054191	109	5054477	110
5053306	89	5053961	112	5054193	109	5054479	110
5053313	89	5053963	112	5054195	109	5054482	110
5053316	89	5053965	112	5054199	109	5054509	115
5053336	87	5053967	112	5054202	109	5054516	115
5053339	87	5053969	112	5054206	109	5054521	115
5053343	87	5053972	112	5054208	109	5054523	115
5053346	87	5053974	112	5054211	109	5054532	111
5053349	87	5053976	112	5054213	109	5054536	111
5053353	87	5054003	113	5054215	109	5054538	111
5053356	87	5054008	113	5054217	109	5054541	111
5053376	86	5054013	113	5054222	109	5054543	111
5053379	86	5054015	113	5054224	109	5054545	111
5053383	86	5054019	113	5054246	108	5054547	111
5053386	86	5054022	113	5054251	108	5054549	111
5053389	86	5054024	113	5054253	108	5054552	111
5053393	86	5054026	113	5054255	108	5054635	115
5053396	86	5054028	113	5054257	108	5054636	115
5053399	86	5054031	113	5054259	108	5054637	115
5053403	86	5054033	113	5054262	108	5054638	115
5053406	86	5054035	113	5054264	108	5054639	115
5053409	86	5054037	113	5054266	108	5054641	115
5053429	87	5054039	113	5054286	109	5054642	115
5053433	87	5054042	113	5054291	109	5054706	117
5053439	87	5054044	113	5054293	109	5054708	117
5053446	87	5054046	113	5054295	109	5054711	117
5053449	87	5054048	113	5054297	109	5054713	117
5053453	87	5054051	113	5054299	109	5054715	117
5053456	87	5054053	113	5054302	109	5054717	117



NRF nr.	Side	NRF nr.	Side	NRF nr.	Side	NRF nr.	Side
5054719	117	8710064	60	8710173	58	8710337	66
5054722	117	8710065	60	8710174	58	8710338	66
5054736	117	8710066	60	8710175	58	8710339	66
5054741	117	8710067	60	8710176	58	8710341	66
5054743	117	8710068	60	8710177	58	8710342	66
5054745	117	8710069	60	8710178	58	8710343	66
5054747	117	8710083	62	8710179	58	8710344	66
5054749	117	8710084	62	8710194	66	8710345	66
5054752	117	8710085	62	8710195	66	8710346	66
5054754	117	8710086	62	8710203	58	8710347	66
5054756	117	8710087	62	8710204	58	8710348	66
6166397	171	8710088	62	8710205	58	8710349	66
6166398	170	8710089	62	8710206	58	8710351	66
6166445	243	8710103	62	8710207	58	8710352	66
6166679	169	8710105	62	8710208	58	8710353	66
6166786	169	8710107	62	8710209	58	8710362	68
6166787	169	8710108	62	8710223	63	8710363	68
6167051	242	8710109	62	8710224	63	8710364	68
6167053	231	8710111	62	8710225	63	8710365	68
6167057	252	8710112	62	8710226	63	8710366	68
6167401	243	8710113	62	8710227	63	8710367	68
6167402	242	8710114	62	8710228	63	8710368	68
6167404	244	8710115	62	8710229	63	8710403	94
6167405	241	8710116	62	8710231	63	8710404	94
6167406	242	8710117	62	8710234	63	8710405	94
6167411	245	8710118	62	8710236	63	8710406	94
6167414	245	8710119	62	8710237	63	8710407	94
8710003	59	8710121	62	8710243	64	8710408	94
8710004	59	8710122	62	8710244	64	8710409	94
8710005	59	8710123	62	8710245	64	8710423	94
8710006	59	8710133	63	8710246	64	8710424	94
8710007	59	8710134	63	8710248	64	8710425	94
8710008	59	8710135	63	8710249	64	8710426	94
8710009	59	8710136	63	8710251	64	8710427	94
8710023	60	8710137	63	8710252	64	8710428	94
8710024	60	8710138	63	8710255	64	8710429	94
8710025	60	8710139	63	8710256	64	8710443	94
8710026	60	8710141	63	8710273	65	8710444	94
8710027	60	8710142	63	8710274	65	8710445	94
8710028	60	8710143	63	8710275	65	8710446	94
8710029	60	8710144	63	8710276	65	8710447	94
8710031	67	8710145	63	8710277	65	8710448	94
8710032	67	8710146	63	8710283	65	8710449	94
8710033	67	8710153	59	8710284	65	8710463	94
8710034	67	8710154	59	8710285	65	8710464	94
8710035	67	8710155	59	8710286	65	8710465	94
8710036	67	8710156	59	8710287	65	8710466	94
8710037	67	8710157	59	8710323	68	8710467	94
8710043	59	8710158	59	8710324	68	8710468	94
8710044	59	8710159	59	8710325	68	8710469	94
8710045	59	8710161	59	8710331	66	8710483	96
8710046	59	8710162	59	8710332	66	8710484	96
8710047	59	8710163	59	8710333	66	8710485	96
8710048	59	8710164	59	8710334	66	8710486	96
8710049	59	8710165	59	8710335	66	8710487	96
8710063	60	8710166	59	8710336	66	8710488	96

NRF nr.	Side	NRF nr.	Side	NRF nr.	Side	NRF nr.	Side
8710489	96	8710627	97	8710773	67	9816723	313
8710503	96	8710628	97	8710774	58	9816724	313
8710504	96	8710629	97	8710775	58	9816725	313
8710505	96	8710631	97	8710776	58	9816726	313
8710506	96	8710632	97	8710777	68	9816727	313
8710507	96	8710633	97	8710778	68	9816728	313
8710508	96	8710634	97	8710779	68	9816729	314
8710509	96	8710635	97	8710781	58	9816776	313
8710511	96	8710636	97	8710782	58	9816777	313
8710514	96	8710643	97	8710783	58	9816782	313
8710515	96	8710644	97	8710784	63	9816884	316
8710516	96	8710645	97	8710785	63	9816898	316
8710517	96	8710646	97	8710786	63		
8710518	96	8710647	97	8710787	63		
8710519	96	8710648	97	8710788	63		
8710521	96	8710649	97	8710789	66		
8710522	96	8710651	97	8710791	64		
8710523	96	8710652	97	8710792	64		
8710533	96	8710655	97	8710793	59		
8710534	96	8710656	97	8710794	59		
8710536	96	8710663	85	8710795	59		
8710538	96	8710664	85	8710796	59		
8710539	96	8710665	85	8710797	59		
8710553	93	8710666	85	8710798	59		
8710554	93	8710673	98	8710799	59		
8710555	93	8710675	98	8710801	59		
8710556	93	8710679	98	8710802	68		
8710557	93	8710683	98	8710803	62		
8710558	93	8710685	98	8710804	62		
8710559	93	8710689	98	8710805	62		
8710561	93	8710723	99	8710806	62		
8710562	93	8710724	99	8710807	62		
8710563	93	8710725	99	8710808	62		
8710564	93	8710729	99	8710809	62		
8710565	93	8710731	99	8710811	62		
8710566	93	8710749	99	8710812	62		
8710573	93	8710751	99	8710813	62		
8710574	93	8710752	99	8710814	62		
8710575	93	8710753	99	8710815	62		
8710576	93	8710754	99	8710816	62		
8710577	93	8710755	99	8710817	62		
8710578	93	8710756	99	8710818	62		
8710579	93	8710757	98	8710819	63		
8710594	98	8710758	65	8710821	62		
8710595	98	8710759	59	8710822	62		
8710603	93	8710761	59	8710823	63		
8710604	93	8710762	59	8710824	63		
8710605	93	8710763	60	8710825	63		
8710606	93	8710764	60	8710826	63		
8710607	93	8710765	60	8710827	63		
8710608	93	8710766	59	8710828	63		
8710609	93	8710767	59	8710829	62		
8710623	97	8710768	59	8710831	62		
8710624	97	8710769	60	8710832	62		
8710625	97	8710771	60	9816721	313		
8710626	97	8710772	60	9816722	313		



Geberit AS
Luhrtoppen 2
1470 Lørenskog

Telefon 67 97 82 00
Telefaks 67 97 82 01
sales@geberit.com

www.geberit.no

